

# Gaskets

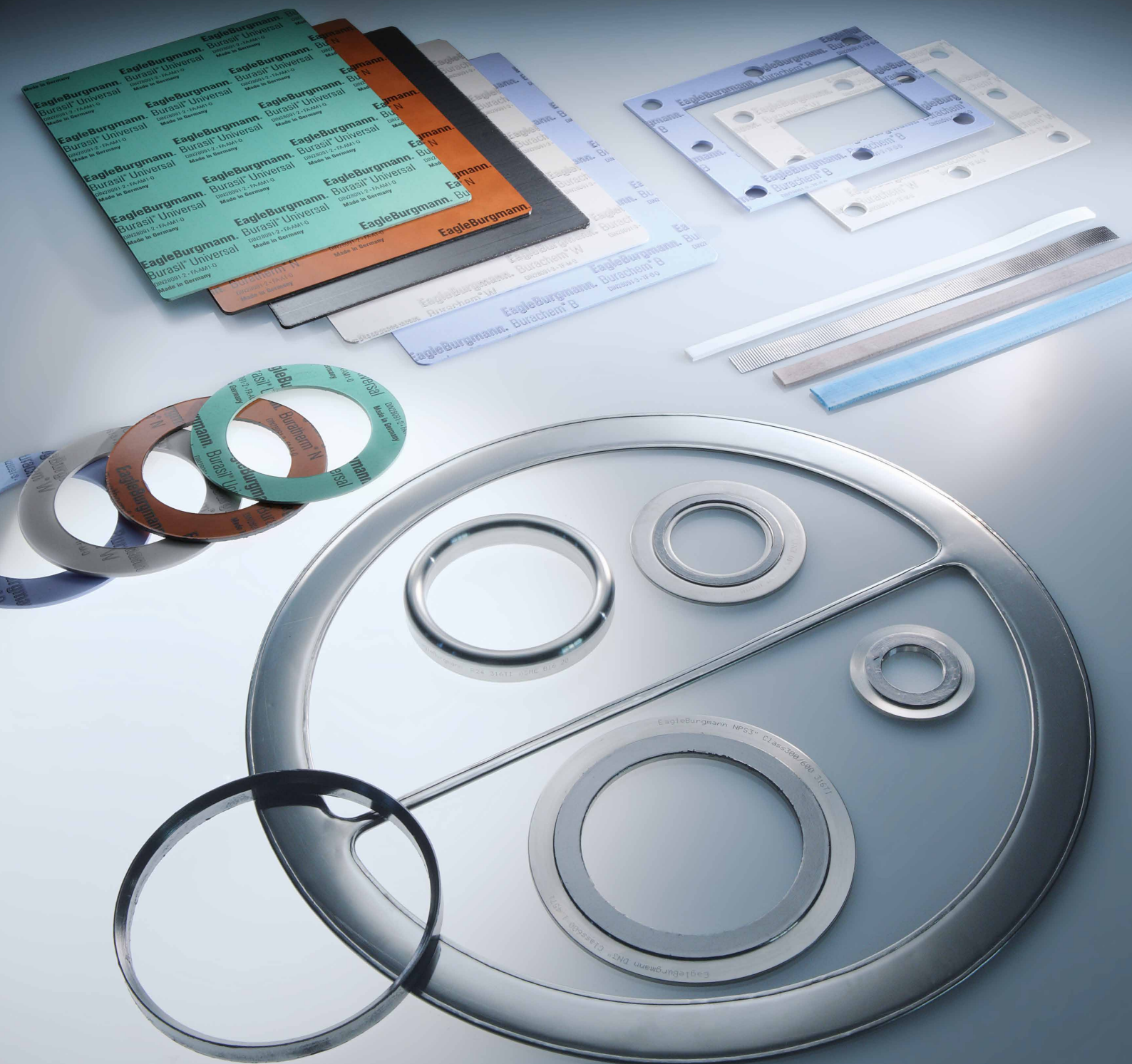

# Reliably safe and efficient operation, maximum cost-effectiveness: Sealing solutions from EagleBurgmann.

## **The right gasket for every application.**

Their role as key components makes seals highly important. They protect in-process products against external influences and contamination, and help prevent emissions. In doing so, they boost the plant's process stability, availability and operating efficiency.

With a broad spectrum of high-quality gaskets ranging from fiber and rubber-based, PTFE types to graphite and metal seals plus the relevant accessories, EagleBurgmann can be relied upon to provide the right sealing solution for every application.

## **Reliable, safe and cost-effective solutions from one single source.**

Besides our comprehensive portfolio of products, our know-how in terms of the respective processes, media and standards enables us to come up with top-grade solutions which are not only technically reliable and safe but also cost-effective into the bargain.

Whatever requirements our customers might have, we know the effects of all factors on functionality and cost-effectiveness – and continually put this know-how into practice in the form of sustainable and reliable sealing solutions.

To this end we have the entire spectrum of competencies needed to accompany, support and enhance the sealing solution's entire development, life and service cycle. From engineering, consultancy and configuration right through to custom-tailored on-site services: EagleBurgmann offers all this from one single source.

# EagleBurgmann gasket selector

The table lists all the key operating data for EagleBurgmann gasketing products – classified according to their various potential applications.

			Fiber		PTFE						Graphite and mica								Metallic													
			Burasil Basic 9544/B	Burasil Universal 9544/U	Buratherm N 9544/N	Quick-Seal 9654	Burachem Multi 9654/MP	Burachem B 9655/B	Burachem R 9655/R	Burachem W 9655/W	Elastic Tankpak 6756	Statotherm P foil 9591/P	Statotherm SSTC-TAL 9592/P	Statotherm 1P 9593/1P	Statotherm HDP 9593/HDP	Statotherm S6P 9593/S6P	Statotherm HT 9560	Statotherm profile ring R901/B	Statotherm tape 6750	Statotherm V9* cover seals	Statotherm V8* cover seals	Spiraltherm graphite 9594	Spiraltherm PTFE 9595	Corrathem 2897	Kammprofile 9598	KH rubber-steel gasket 9107/KH	KN rubber-steel gasket 9107/KN	Buralloy jacketed gasket 2500	Buralloy ring type joint 2961			
Operating pressure			bar	p	80	120	150	100	200	55	83	83	1	60	200	25	250	100	5	500	250	500	800	400	400	50	400	64	64		< 340	
Chemical resistance			pH				0..14	0..14	0..14	0..14	0..14	0..14	0..14	0..14	0..14	0..14	0..14	0..14	0..14	0..14	0..14	0..14	0..14	0..14	0..14	0..14	0..14	0..14	0..14	0..14	0..14	
Temperature resistance			t min.		°C	-50	-100	-100	-240	-240	-210	-210	-50	-200	-240	-200	-250		-200	-200	-200	-200	-200	-200	-200	-200	-200	-200	-30	-30	-270	-200
			t max.		°C	+250	+260	+350	+270	+270	+260	+260	+250	+500	+500	+400	+450	+500		+950	+500	+500	+500	+500	+500	+500	+500	+500	+500	+500	+130	+130
Transient peak temperature					°C	+350	+380	+450	+315	+315					+500			+1.100			+650			+500				+200	+800	+800		
Temperature limit for continuous steam service					°C							+550	+550	+550	+550	+550	+550	+550	+550	+550	+550				+550				+550	+550		
1;1	Water, industrial water, sewage		■	■	■	□	□	□	□	□	□	□	□	□	□	□	□	□	□	□	□	□	□	□	□	□	□	□	□	□	□	
1;2	Sea water		■	■	■	□	□	□	□	□	□	□	□	□	□	□	□	□	□	□	□	□	□	□	□	□	□	□	□	□	□	
2	Drinking water, foodstuffs, pharm. products		□	□	□	■	■	■	■	■	■	■	■	■	■	■	■	■	■	■	■	■	■	■	■	■	■	■	■	■	■	■
3	Hot water, boiler feed water, condensate		□	■	■							■	■	■	■	■	■	■	■	■	■	■	■	■	■	■	■	■	■	■	■	■
4;1	Steam < 280 °C				■							■	■	■	■	■	■	■	■	■	■	■	■	■	■	■	■	■	■	■	■	■
4;2	< 450 °C										■	■	■	■	■	■	■	■	■	■	■	■	■	■	■	■	■	■	■	■	■	■
4;3	< 550 °C* < 700 °C*										■	■	■	■	■	■	■	■	■	■	■	■	■	■	■	■	■	■	■	■	■	■
5	Neutral vapors, gases, air, nitrogen		■	■	■	■	■	■	■	■	■	■	■	■	■	■	■	■	■	■	■	■	■	■	■	■	■	■	■	■	■	■
6	Acid gases					■	■	■	■	■	■	□	□	□	□	□	□	□	□	□	□	□	□	□	□	□	□	□	□	□	□	□
7;1	Hydrogen			■	■	■	■	■	■	■	□	■	■	■	■	■	■	■	■	■	■	■	■	■	■	■	■	■	■	■	■	■
7;2	Oxygen			■	■	■	■	■	■	■	■	■	■	■	■	■	■	■	■	■	■	■	■	■	■	■	■	■	■	■	■	■
8	Volatile hydrocarbons, solvent vapors					■	■	■	■	■	□	■	■	■	■	■	■	■	■	■	■	■	■	■	■	■	■	■	■	■	■	■
9	Diluted acids, inorganic / organic salt solutions			■	■	■	■	■	■	■	□	□	□	□	□	□	□	□	□	□	□	□	□	□	□	□	□	□	□	□	□	□
10	Concentrated acids, inorganic / organic			□	□	■	■	■	■	■	□	□	□	□	□	□	□	□	□	□	□	□	□	□	□	□	□	□	□	□	□	□
11	Diluted alkalis, salt solutions			■	■	□	□	□	□	□	□	□	□	□	□	□	□	□	□	□	□	□	□	□	□	□	□	□	□	□	□	□
12	Concentrated alkalis			□	□	■	■	■	■	■	■	■	■	■	■	■	■	■	■	■	■	■	■	■	■	■	■	■	■	■	■	■
13	Oils, greases, mineral oils, animal fats			■	■	□	□	□	□	□	□	■	■	■	■	■	■	■	■	■	■	■	■	■	■	■	■	■	■	■	■	■
14	Heat transfer oils			■	■							■	■	□	■	□	□	■	■	■	■	■	■	■	■	■	■	■	■	■	■	■
15	Solvents, aliphatic and aromatic hydrocarbons, aldehydes, alcohols, esters, ketones, chlorinated hydrocarbons, coolants				□	■	■	■	■	■	□	■	■	□	■	■	■	■	■	■	■	■	■	■	■	■	■	■	■	■	■	■
16	Organic compounds, amines, nitrites			■	■	■	■	■	■	■	□	□	□	□	□	□	□	□	■	■	■	■	■	■	■	■	■	■	■	■	■	■
17;1	Adhesive media, bitumens, glues			■	■	■	■	■	■	■	■	□	□	□	□	□	□	□	■	■	■	■	■	■	■	■	■	■	■	■	■	■
17;2	Abrasive media, lime, sand, solids			■	■							□	□	□	□	□	□	□	■	■	■	■	■	■	■	■	■	■	■	■	■	
18	Paints, lacquers, turbine oils			■	■	■	■	■	■	■	■	■	■	□	■	■	■	■	■	■	■	■	■	■	■	■	■	■	■	■	■	■

\* In inert atmosphere

□ Resistant ■ Recommended

### Important note

All the technical specifications are based on extensive tests and our many years of experience. However, the diversity of possible applications means that they can serve as guide values only.

It should be noted that the extremal values of each operating parameter cannot be applied at the same time because of their interaction. Furthermore, the operating range of each specific product depends on the respective pressure, external forces and influences, temperature and on the medium to be sealed.

A guarantee can only be given in the individual case if the exact conditions of application are known and these are confirmed in a special agreement. When critical conditions of operation are involved, we recommend consulting with our specialist engineers.

Media	Media group	Media	Media group	Media	Media group	Media	Media group
<b>A</b>		Cresol	16	<b>K</b>		<b>S</b>	
Accumulator acid	10	Crude oil	13	Kerosene (Jet fuel JP 4, JP 5)	15	Salicylic acid	9; 10
Acetaldehyde	15; 16	Cuprous chloride solution	9; 11			Salt, common (Sodium chloride)	9; 11
Acetic acid	9; 10	Curds	2	<b>L</b>		Sea water	1.2
Acetic acid anhydride	10	Cyclohexane	8; 15	Lacquers	18	Sewage water	1.1
Acetic ether (Ethyl acetate)	8; 15	Cyclohexanol	15	Lead acetate (Lead sugar)	11	Silicon tetrachloride	9; 10
Acetone	8; 15	Cyclohexanone	13; 15	Lead sludge	17.2	Silicone fats	13
Acetylene	8; 15			Lemonades	2	Silicone oils	13
Acrylonitrile	16	<b>D</b>		Lignite tar oil	13; 17.1	Silver salts	9
Adipinic acid	9; 10	Dibutyl phthalate (DBP)	16	Liqueurs	2	Skin creams	2; 13
Alcohol (Ethanol)	15	Diesel fuel				Soap solution	11
Aluminium acetate	9; 11	Diethanolamine (DEA)	11; 13; 16	<b>M</b>		Soda lye ≤30 % all conc.	11; 12
Aluminium chloride	9; 11	Diethyl ether	8; 15	Magnesium bisulphite	9; 11	Sodium arsenate	9; 11
Aluminium sulphate	9; 11	Diethyl glycol	8; 15	Magnesium hydroxide	11; 12	Sodium carbonate	11; 12
Ammonia (gaseous)	11; 12	Dimethyl ether	8; 15	Maleic acid anhydride	10	Sodium chloride (Common salt)	9; 11
Ammonia (liquid)	11; 12	Dioxane	16	Manganese nitrate	9; 11	Sodium hydroxide (Caustic soda)	11; 12
Ammonia hydroxide	11; 12	Diphenyl heat transfer fluid	14	Manure, liquid	11	Sodium hypochlorite	9; 11
Ammonium chloride	9; 11	Diphenyl oxide	15; 16	Marmalade	2	Sodium nitrate	9; 11
Ammonium sulphate	9; 11	Distilled water	2	Mash (Hop mash)	2	Sodium phosphate	9; 11
Aniline	16	Dodecylbenzene	15	Masut (Heavy heating oil)	13	Sodium silicate (Water glass)	9; 11
Anthracene oil	13	Dowtherm® A	14	Meat juices and broths	2	Sodium sulphate (Glauber's salt)	9; 11
Antifreeze solution (Glycols)	15	Dye liquor	17.1	Mercaptane	16	Sodium sulphide	9; 11
Arsenic acid	9; 10			Mercury nitrate	9; 11	Sodium sulphite	9; 11
Asphalt	17.1	<b>E</b>		Methane	8	Sodium thiosulphate (Antichlor)	9; 11
ASTM oil No. 1, 2, 3 and 4	13	Edible oil	2; 13	Methanol (Methylic alcohol)	15	Solvent naphtha	15
		Edible vinegar	9	Methyl chloride	8; 15	Starch solutions	17.1
<b>B</b>		Ethane	15	Methyl ethyl ketone (MEK)	8; 15	Steam	4.1; 4.2; 4.3
Barium chloride	9; 11	Ethanol (Ethylic alcohol)	15	Methylated spirit	15	Stearic acid (Fatty acid)	9; 10
Barium hydroxide	11; 12	Ether (Diethyl ether)	8; 15	Methylene chloride	8; 15	Styrene (Phenyl ethylene)	15
Beer	2	Ethyl acetate (Acetic ether)	15	Milk	2	Sulphite liquor	9; 11
Beer mash, cooper	2	Ethyl cellulose	8	Milk of lime (Calcium hydroxide)	11; 12	Sulphuric acid	
Beer mash, pumps	2	Ethylene	8	Mineral oil (Crude oil)	13	70 – 90 % 150 °C	10
Benzaldehyde	15	Ethylene chloride	6; 15	Mineral oil	13	90 – 95 % 70 °C	10
Benzene	15	Ethylene glycol	16	Mobiltherm® 600	14	Sulphuric acid, fuming (Oleum)	10
Benzene sulphonic acid	10	Ethylene oxide	8	Molasses	2; 17.1	Sulphurous acid	9; 10
Benzoic acid	9; 10			Monochloro benzene	8; 15		
Benzyl alcohol	15	<b>F</b>		<b>N</b>		<b>T</b>	
Bitumen	17.1	Faeces	1.1	N-methyl-pyrrolidone (NMP)	15	Tallow	13
Blast furnace gas	6	Fats and fatty alcohols	13; 15	Naphtha	15	Tannic acid	9; 10
Bleaching lye	11	Fatty acids	9; 10	Naphthenic acid	9; 10	Tar	17.1
Blood	2	Fatty alcohol sulphonate	11	Natural gas	5	Tartaric acid	9
Boiler feed water	3	Ferric (III) chloride solution	9; 10	Nitric acid	9; 10	Tetrachloromethane	8; 15
Bonder lye	9; 10; 11; 12	Ferric phosphate solution	9; 11	<10 % 85 °C	9; 10	Tetrahydrofuran	15
Bone fat (dissolved in tri or gasoline)	15	Ferricyanide	9; 11	>10 % 35 °C	10	Thick juice (60 % Sugar solution)	2
Borax solution	11	Fish press water	1.1	Nitrobenzenes	15	Thin juice (Sugar solution)	2; 17.1
Boric acid	9	Fish slurry	1.1	Nitrogen	5	Tin salts	9
Brackish water	11	Fish-liver oil	13	Nonyl phenol	15	Toluene	15
Brake fluid	13	Fixing bath, acidic	9	<b>O</b>		Trichloroethane	15
Brandy	2; 15	Fluorosilicic acid	10	Oils		Trichloroethylene	15
Bromine, aqueous	9; 10	Formaldehyde (Formalin)	15; 16	a) Animal oils	13	Triethanolamine	11; 16
Bunker oil and fuel	13	Formic acid	9; 10	b) Vegetable oils	13	Trisodium phosphate	9; 11
Butadiene	16; 17.1	Freon®	8; 15	c) Lubricating oils	13	Turbine oils	18
Butane	8; 15	Frigene®	8; 15	Olive oil	2; 13	Turpentine	15
Butanediol	15	Fruit juices	2	Oxalic acid	9; 10	<b>U</b>	
Butanol (Butylic alcohol)	15	Fruit pulp	2	Oxygen (gaseous, liquid)	7.2	Urea	11; 16
Butanone (Methyl ethyl ketone)	15	Fuel oil	15			<b>V</b>	
Butylene	8; 15	Fully desalinated water	1.1	<b>P</b>		Vegetable paste	2
Butyl acetate	15	<b>G</b>		P 3® lye	10; 11; 12	Vinegar (Edible vinegar)	9
Butyl alcohol (Butanol)	15	Gallic acid	9; 10	Paints	18	Vinyl chloride	8
Butyric acid	2; 9; 10	Gas scrubbing water	1.1; 9	Paper pulp		<b>W</b>	
<b>C</b>		Gelatin	2	a) Fine quality, hygienic	17.2	Water glass (Sodium silicate)	9; 11
Calcium acetate	9; 11	Glacial acetic acid	10	b) Synthetic, photographic	9; 11; 17.2	Water	
Calcium bisulphite liquor (Sulphite liquor)	9; 11	Glauber's salt (Sodium sulphate)	9; 11	c) Packing paper	9; 11; 17.2	a) Drinking	2
Calcium chloride	9; 11	Glucose	2	Peanut oil	13	b) Distilled	3
Calcium hydroxide (Milk of lime)	11; 12	Glue	17.1	Pentane	8; 15	c) Not treated	1.1
Calcium hypochlorite (Bleaching lye)	9; 11	Glycerol	15	Perchloric acid	9; 10	d) Boiler feed (hot water, condensate)	3
Calgonit R® (Caustic soda phosphate silicate)	11	Glycolic acid ester	8; 15	Perchloro ethylene (Per)	8; 15	e) Reactor, radioactive	1.1
Calgonit S® (Urea nitrate)	11; 12	Glycolmonoacetate	8; 15	Petrol	15	f) Heavy	1.1
Calgonit® (Na-hexameta-phosphate)	11	<b>H</b>		Petroleum	15	g) Brackish, sea	1.2
Caprolactam	11; 16	Heat transfer oil	14	Petroleum ether (Gasoline)	8; 15	h) Dirty	1.1
Carbolic acid (Phenol)	9; 10	Heating oil	13	Phenol (Carbolic acid)	9; 10	Whale oil, train oil	13
Carbon bisulphide	15	Heavy water	1.1	Phenyl ether	8; 15	Wine	2
Carbon dioxide (gas)	6	Heptane	8; 15	Phenyl hydrazine	8; 15	Wood pulp	11; 17.2
Carbon dioxide (liquid)	6	Hexane	8; 15	Phosphoric acid	9; 10		
Carbon monoxide (gas)	6	Honey	2	Phosphor trichloride	9; 10	<b>X</b>	
Carbon tetrachloride	15	Hydraulic fluid (Mineral oil base)	13	Phthalic acid (heating)	9; 10	Xylene	8; 15
Caustic lime (Calcium hydroxide)	12	Hydraulic fluid (Phosphate ester base)	13	Phthalic acid anhydride	10	<b>Y</b>	
Caustic potash (Potassium hydroxide)	11; 12	Hydrazine	15	Pine oil	13	Yeast pulp	2
Caustic soda (Sodium hydroxide)	12	Hydrochloric acid	9; 10	Potassium carbonate	11; 12	<b>Z</b>	
Cellulose	17.2	Hydrocyanic acid	9; 10	Potassium chloride	9; 11	Zinc chloride	9; 11
Chloric acid gas (Hydrogen chloride)	6; 10	Hydrofluoric acid	10	Potassium cyanide	9; 11		
Chlorine gas	6; 10	Hydrogen	7.1	Potassium hypochlorite	9; 11		
Chlorine water (chlorine-saturated water)	10	Hydrogen bromide	6; 9; 10	Potassium nitrate	9; 11		
Chloroacetic acid (mono, di)	9	Hydrogen chloride (Chloric acid gas)	6; 9; 10	Potassium nitrate	9; 11		
Chlorosulphonic acid	10	Hydrogen peroxide	10	Potassium silicate	9; 11		
Chlorobenzene	15	Hydrogen sulphide	6; 9; 10	Potassium sulphate	9; 11		
Chlorodiphenyl	15	<b>I</b>		Propane	8; 15		
Chloroform	15	Iso-octane	8; 15	Propanol (Propyl alcohol)	15		
Chloroparaffins	15; 17.1	Isobutyl alcohol	8; 15	Propanone	8; 15		
Chromic acid	10	Isobutyl ketone	8; 15	Propyl acetate (Acetic acid ester)	8; 15		
Chromic salts	9; 11	Isopropyl acetate	8; 15	Pyridine	15; 16		
Cider	2	Isopropyl alcohol	8; 15	Pyrrolidone	11; 12		
Citric acid	9; 10	Isopropyl ether	8; 15	<b>Q</b>			
Citric juices	2; 9			Quenching oil	13		
Coconut fat	13			<b>R</b>			
Cod-liver oil	2			Rapeseed oil	13		
Coke oven gas	5			Raw juice (Sugar solution)	2		
Copper acetate solution	9; 11						
Copper sulphate solution	9; 11						

# Contents



EagleBurgmann has been developing, manufacturing and installing sophisticated sealing systems for over 125 years. Our continuing success is firmly founded on uncompromising orientation to ensuring the very highest degrees of safety, reliability and cost-effectiveness for our customers. Many of our sealing solutions are developed in close cooperation with industrial plant operators – with the clear advantage that optimal account can thus be taken of the specific processes and conditions on site.

Requirements on the environmental compatibility of industrial facilities are growing all the time, with the result that the development of gaskets in particular is gaining increasing importance. This is because they, as industrial bulk products, have to offer the greatest possible safety and durability. EagleBurgmann's products meet these requirements – and we go several steps further in the interests of protecting people and the environment; we give our customers active on-site support towards



selecting the best solution. However, we never stop optimizing our products and services since what is already good can be made even better. After all, our top priority lies in ensuring our customers' absolute satisfaction. This is reflected in, for example, our modular TotalSealCare service concept combining advice, engineering and on-site service with conversion, retrofitting and standardization measures. That eases our customers' workload, especially where maintenance-intensive facilities or staffing bottlenecks during general overhauls are concerned. The result is that operations can be resumed faster – and this in turn substantially improves the cost-effectiveness factor.

This catalog provides an overview of our standard range of products, but we also have a broad spectrum of further variants to meet your particular needs and requirements. Please do not hesitate to contact us – we shall be only too pleased to solve your sealing requirements.

## Gasket sheets and sealants

Fiber gasket sheets .....	4
PTFE gasket sheets .....	6
PTFE sealants and tapes .....	9
Graphite gasket sheets .....	16
Graphite seals and tapes .....	20
Graphite maintenance seals .....	22
Mica gasket sheets .....	23

## Metallic gaskets

Spiral wound gaskets .....	24
Corrugated gaskets .....	28
Kammprofile gaskets .....	29
Jacketed gaskets .....	30
Ring type joints .....	32
Rubber-steel gaskets .....	34
Tools, maintenance products .....	36
Gasket dimensions .....	37
Service, compression packings .....	52
Additional EagleBurgmann product lines .....	53

Program overview with operating data and media resistance guide.

### How to find the right gasket quickly and easily:

Open out the flap for a complete overview of all the comparative data needed for selecting sealing solutions as you look through the brochure. If you still fail to find a satisfactory solution quickly enough or are unsure about borderline cases, please contact your local EagleBurgmann sales office for assistance. We shall be glad to assist you.



# Choice of gaskets

Standard gasket types – Operation range

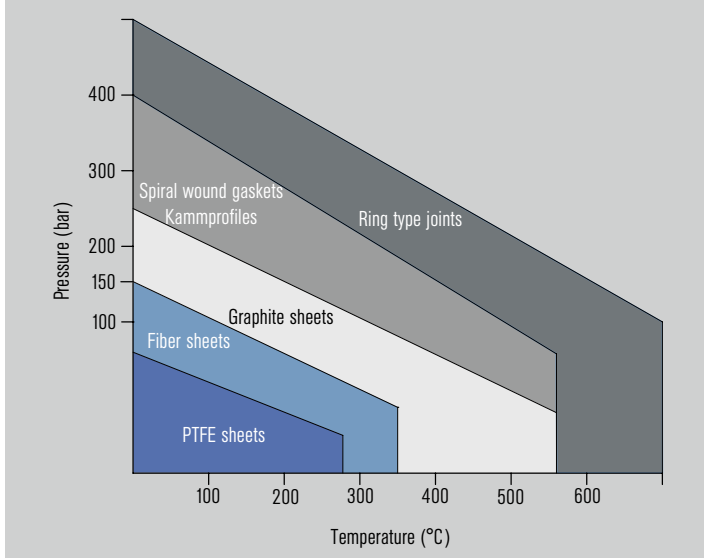

Gasket duration

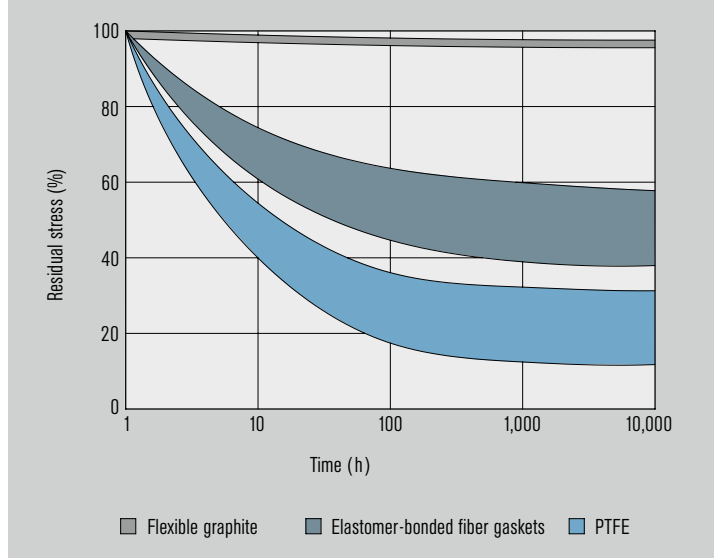

The choice of gasket materials and gasket styles can be confusing when you look at all the products which are currently available. To assist you in selecting the best gasket solution for your application, here are some key considerations for your selection.

When choosing a gasket you always have to balance the following requirements:

- Performance
- Safety
- Reliability
- Service life
- Cost

A gasket's performance must be capable of withstanding all of the operating conditions imposed by the application – pressure, temperature, thermal cycling, shock loading, chemical resistance, safety requirements, etc.

Reliability is of paramount importance since the cost of the gasket is relatively small compared to the potential costs of gasket failure. These costs cannot only be direct replacement costs but also consequential costs due to loss of production and personal injury. The quality of the materials used in the manufacturing of the gasket will have a direct impact on its performance and reliability.

For example, expanded graphite of the same nominal purity from different suppliers can have widely different quantities of specific impurities, etc. These will affect the life of the gasket, its rate of volume loss at elevated temperatures and the corrosion effect upon metal components in valves, etc.

**Note**

For a safe installation use dry and undamaged gaskets. Wet graphite gaskets should be installed after complete drying.

### Gasket service life

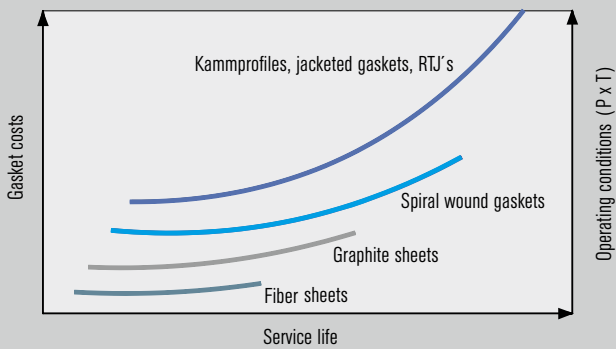

### Gasket cost

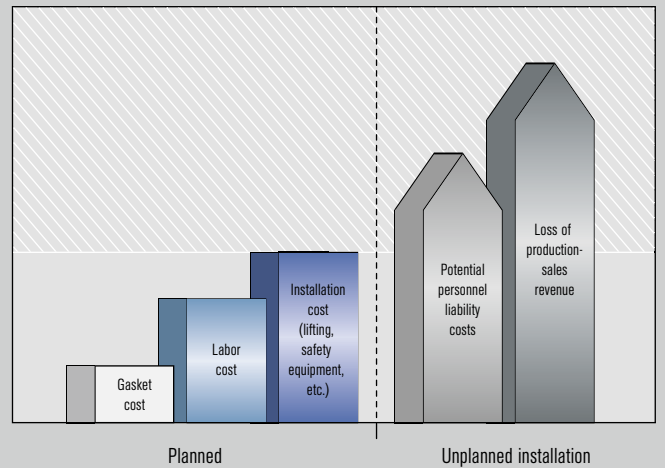

Service life expectations will be determined by the application and the equipment and process in which it is installed. Some gaskets will be required to work for the life of the equipment without replacement while other gaskets will be replaced every time that the equipment is maintained.

Cost is always critical, particularly when trying to keep within a strict maintenance and operating budget. Any unexpected and unplanned failure will increase costs dramatically especially when considering potential personnel liability costs and loss of production. Measured against these two extraordinary costs purchasing the cheapest gasket could eventually cost thousands times more than its cost price.

Finally, no gasket will perform correctly if it is installed badly or if the joint system is not monitored and maintained. It is becoming quite common for process plant operators to provide formal training for technicians in the correct installation techniques for bolted joints. EagleBurgmann provides profound seminars and on-site training modules to support our customers.

Many companies are now instituting bolted joint monitoring and maintenance programs to ensure maximum process time and a minimum of unplanned stoppages. EagleBurgmann staff are always available to train technicians to the skill levels required by the relevant international standards and guidelines, e.g. CEN/TS 1591-part 4.



# Fiber gasket sheets

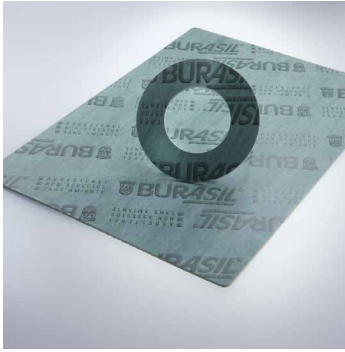

## Burasil Basic 9544/B

### Features

Standard gasket sheet with a balanced mixture of basic materials for flange and flange-like connections in common service pressure and temperature applications.

### Advantages

- Good chemical resistance
- Low gas leakage
- Good residual stress

Synthetic sheet made of high-quality aramid fibers, fillers and NBR (Nitrile Butadiene Rubber). Sheet is manufactured with anti-stick coating on one side.

### Operating range

Pressure:  $p = 80$  bar  
 Temperature:  $t = -50$  °C ...  $+250$  °C (constant),  $+350$  °C (transient peak)  
 Residual stress: acc. to DIN 52913 (16 hours, 300 °C) 18 N/mm<sup>2</sup>

### Forms of supply

Sheet size: 1,500 x 1,500 mm; 1,000 x 1,500 mm; 3,000 x 1,500 mm  
 Thickness: 0.3/0.5/1.0/1.5/2.0/3.0 mm  
 Gaskets and rings

### Recommended applications

- Process industry
- Pulp and paper industry
- Water and waste water technology
- Mining industry
- Building services industry
- Shipbuilding
- Sugar industry
- Resistant to dilute solutions and a variety of chemicals, fuels, oils, solvents and gaseous media

- Centrifugal pumps
- Covers
- Hatches
- Flange connections
- Pipe connections

### Standards and approvals

- DVGW
- HTB
- WRC

### Variants

- 9544/BR (cut gasket)

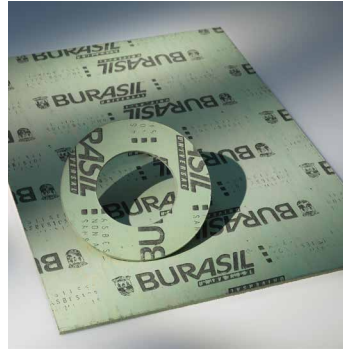

## Burasil Universal 9544/U

### Features

Universal gasket sheet consisting of high-quality aramid fibers, special fillers and NBR (Nitrile Butadiene Rubber). Suitable for thermally and mechanically highly stressed gasket connections.

### Advantages

- Good chemical resistance
- Good tensile strength
- High residual stress
- Very low gas leakage
- Very good oil resistance
- Soft gasket sheet to conform more easily to the flange surface
- PTFE-coated on both sides for easy removal

### Operating range

Pressure:  $p = 120$  bar  
 Temperature:  $t = -100$  °C ...  $+260$  °C (constant),  $380$  °C (transient peak)  
 Residual stress acc. to DIN 52913 (16 hours/300 °C) 25 N/mm<sup>2</sup>

### Forms of Supply

Sheet size: 1,500 x 1,500 mm; 1,000 x 1,500 mm; 3,000 x 1,500 mm  
 Thickness: 0.3/0.5/1.0/1.5/2.0/3.0 mm  
 Gaskets and rings

### Recommended applications

- Process industry
- Oil and gas industry
- Petrochemical industry
- Chemical industry
- Pharmaceutical industry
- Power plant technology
- Pulp and paper industry
- Food and beverage industry
- Metal production and processing
- Resistant to the most important groups of media: water/steam, dilute solutions, acids, alkalis, oils/coolants, solvents, gases
- Centrifugal pumps
- Compressors
- Agitators
- Mixers
- Dryers
- Refiners
- Valves
- Heat exchangers
- Hatches
- Reactor vessels
- Process vessels
- Flange connections

### Standards and approvals

- DVGW
- KTW
- HTB
- BAM (O<sub>2</sub>)
- WRAS
- TA-Luft

### Variants

- 9544/UR (cut gasket)
- 9544/UTH (PTFE envelope gasket)
- 9544/URG (eyeleted gasket)

Fiber gasket sheet physical properties		Burasil Basic 9544/B	Burasil Universal 9544/U	Buratherm N 9544/N
Identification	DIN 28 091-2	FA-A1-0	FA-AM1-0	FA-A1-0
Density (g/cm <sup>3</sup> )	DIN 28 090-2	1.70	1.80	1.70
Tensile strength	DIN 52 910			
Longitudinal (Mpa)		14	27	18
Transverse (Mpa)		6	10	14
Residual stress $\epsilon_{res}/16$	DIN 52 913			
at 175 °C (Mpa)		28	39	37
at 300 °C (Mpa)		18	25	30
Compressibility (%)	ASTM F 36 J	6	6	7
Recovery (%)	ASTM F 36 J	55	60	60
Cold compressibility $\epsilon_{KSW}$ (%)	DIN 28090-2	8	6	6
Cold recovery $\epsilon_{KRW}$ (%)	DIN 28090-2	3	3	3
Hot creep $\epsilon_{WSW}$ (%)	DIN 28090-2	22	5.5	6
Hot recovery $\epsilon_{WRW}$ (%)	DIN 28090-2	2	2	2
Recovery R (mm)	DIN 28090-2	0.04	0.04	0.04
Specific leakage rate	DIN 3535-6	$\leq 0.1$ mg/(m <sup>2</sup> s)	$\leq 0.1$ mg/(m <sup>2</sup> s)	$\leq 0.1$ mg/(m <sup>2</sup> s)
Specific leakage rate $\lambda_{2.0}$	DIN 28090-2	0.1 mg/(m <sup>2</sup> s)	0.1 mg/(m <sup>2</sup> s)	$\leq 0.1$ mg/(m <sup>2</sup> s)
Fluid resistance	ASTM F 146			
ASTM IRM 903 – weight change	5 h/150 °C	7 %	6 %	$\leq 10$ %
ASTM IRM 903 – thickness increase	5 h/150 °C	2 %	2 %	$\leq 5$ %
ASTM Fuel B – weight change	5 h/23 °C	9 %	7 %	$\leq 10$ %
ASTM Fuel B – thickness increase	5 h/23 °C	5 %	6 %	$\leq 5$ %
Chloride content	Siemens AV-9-014	$\leq 150$ ppm	$\leq 150$ ppm	$\leq 50$ ppm





### Buratherm N 9544/N

#### Features

Soft gasket material with the most up-to-date combination of graphite with reinforcement of para-aramid fiber and reduced fillers. Outstanding surface conformity and highly effective anti-stick coating on both sides.

#### Advantages

- High compression strength
- Long service life
- Easy handling
- No hardening

A superb universal gasket material. Much wider field of applications in comparison to other fiber-based materials with regard to mechanical performance under temperature and also in respect of chemical resistance due to the high content of graphite.

#### Operating range

Pressure:  $p = 150 \text{ bar}$   
 Temperature:  $t = -100 \text{ °C} \dots +350 \text{ °C}$   
 (constant),  $+450 \text{ °C}$  (transient peak)

#### Forms of supply

Sheet size:  $1,500 \times 1,500 \text{ mm}$   
 Thickness:  $0,5/0,8 \text{ mm}$   
 Sheet size:  $2,000 \times 1,500 \text{ mm}$   
 Thickness:  $1.0/1.5/2.0/3.0 \text{ mm}$

#### Recommended applications

- Process industry
- Oil and gas industry
- Petrochemical industry
- Chemical industry
- Pharmaceutical industry
- Power plant technology
- Metal production and processing
- Oils and greases, acids and alkalis, solvents, coolants, water, steam
- Centrifugal pumps
- Piston pumps
- Compressors
- Fans
- Blowers
- Valves
- Heat exchangers
- Flange connections
- Pipe connections

#### Standards and approvals

- DVGW
- KTW
- WRC
- W270
- HTB
- BAM (max.  $120 \text{ °C}/130 \text{ bar}$ )
- TA-Luft

#### Variants

- 9544/NR (cut gasket)
- 9544/NTH (PTFE envelope gasket)
- 9544/NRG (eyeleted gasket)

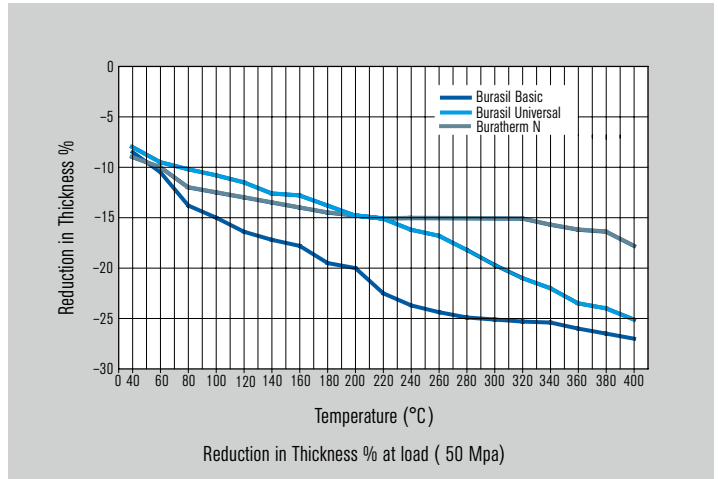

#### Q<sub>S</sub>MAX

Maximum surface pressure that may be imposed on the gasket at the indicated temperatures without collapse or compressive failure of the gasket.

#### Q<sub>MIN(L)</sub>

Minimum gasket surface pressure on assembly required at ambient temperature in order to seat the gasket into the flange facing roughness and close the internal leakage channels so that the tightness class achieved is to the required level **L** for the internal test pressure.

#### L<sub>N</sub>

Tightness classes are defined in terms of specific leakage rates.  
 Tightness class:  $L_{1.0} \quad L_{0.1} \quad L_{0.01}$   
 Specific leakage rate:  $\leq 1.0 \leq 0.1 \leq 0.01$   
 ( $\text{mg s}^{-1} \text{ m}^{-1}$ )

#### Q<sub>S</sub>MIN(L)

Minimum gasket surface pressure required under the service pressure conditions to maintain the required tightness class for the internal application pressure.

#### P<sub>OR</sub>

Factor to simulate the effect of gasket relaxation after bolt tightening with long-term exposure to service temperatures.

#### ASME “m” and “y” factors

Pressure (bar)	Thickness (mm)	Burasil Basic 9544/B			Burasil Universal 9544/U			Buratherm N 9544/N		
		m	y (PSI)	y (Mpa)	m	y (PSI)	y (Mpa)	m	y (PSI)	y (Mpa)
10	1.0	2.5	1,450	10	2.5	2,175	15	2.5	870	6
	1.5	2.5	1,595	11	2.5	1,885	13	2.5	1,015	7
	2.0	2.5	1,740	12	2.5	1,885	13	2.5	1,160	8
	3.0	2.5	1,740	12	2.5	3,045	21	2.5	2,320	16
16	1.0	2.5	1,595	11	2.5	2,610	18	2.5	1,160	8
	1.5	2.5	2,175	15	2.5	2,175	15	2.5	1,305	9
	2.0	2.5	2,465	17	2.5	2,175	15	2.5	1,450	10
	3.0	2.5	2,465	17	2.5	3,335	23	2.5	3,625	25
25	1.0	2.5	2,175	15	2.5	3,045	21	2.5	1,885	13
	1.5	2.5	2,900	20	2.5	2,610	18	2.5	2,320	16
	2.0	2.5	3,190	22	2.5	2,610	18	2.5	2,465	17
	3.0	2.5	3,190	22	2.5	4,060	28	2.5	5,510	38
40	1.0	2.5	3,190	22	2.5	3,625	25	2.5	2,320	16
	1.5	2.5	3,625	25	2.5	3,190	22	2.5	3,045	21
	2.0	2.5	3,915	27	2.5	3,190	22	2.5	3,770	26
	3.0	2.5	3,915	27	2.5	5,220	36	2.5	7,685	53

# PTFE gasket sheets

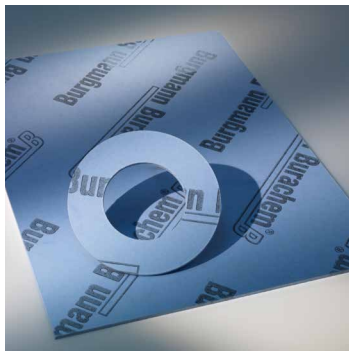

**Burachem Blue 9655/B**

## Features

Burachem B gasket sheet is a PTFE-based sealing material, filled with hollow micro glass beads. It has high chemical resistance and the greatest flexibility of our PTFE gasket sheets.

## Advantages

- Excellent chemical resistance
- Excellent mechanical resistance
- Very low gas leakage (complies with German Fugitive Emission Regulation TA-Luft)
- Minimized cold-flow and creep behavior

Burachem B gasket sheet provides a seal even with low surface pressures and when there are only low bolt forces available. No aging.

## Operating range

Pressure:  $p = \text{vacuum} \dots 55 \text{ bar}$   
 Temperature:  $t = -210 \text{ °C} \dots +260 \text{ °C}$   
 Chemical resistance:  $\text{pH} = 0 \dots 14$

Excellent media resistance throughout the complete pH range including most base chemicals and acids.

Not suitable for fluorine-hydrogens, fluorine compounds or molten alkali metals.

## Forms of supply

Sheet size: 1,200 x 1,200 up to 1.0 mm thickness  
 Sheet size: 1,500 x 1,500 from 1.5 mm thickness  
 Standard thickness: 1.0/1.5/2.0/3.0 mm  
 Cut rings, closed or in segments

## Recommended applications

- Process industry
- Petrochemical industry
- Chemical industry
- Pharmaceutical industry
- Food and beverage industry
- Covers
- Hatches
- Reactor vessels
- Process vessels
- Flange connections
- Pipe connections
- Maintenance seals

## Standards and approvals

- FDA 21CFR 177.1550
- TA-Luft

## Variant

9655/BNR (rings)



**Burachem Brown 9655/R**

## Features

PTFE-based sealing material, filled with silica. Compared to conventional PTFE, this gasket material is suitable for considerably higher pressure and temperature applications.

## Advantages

- Excellent chemical resistance
- Excellent mechanical resistance
- Very low gas leakage (complies with German Fugitive Emission Regulation TA-Luft)
- Minimized cold-flow and creep behavior

Ideal gasket sheet for standardization because Burachem R offers best all-round mechanical and chemical properties.

## Operating range

Pressure:  $p = \text{vacuum} \dots 83 \text{ bar}$   
 Temperature:  $t = -210 \text{ °C} \dots +260 \text{ °C}$   
 Chemical resistance:  $\text{pH} = 0 \dots 14$

Resistant throughout the complete pH range as well as against concentrated acids.

## Forms of supply

Sheet size: 1,200 x 1,200 up to 1.0 mm thickness  
 Sheet size: 1,500 x 1,500 from 1.5 mm thickness  
 Standard thickness: 1.0/1.5/2.0/3.0 mm  
 Cut rings, complete or in segments

## Recommended applications

- Process industry
- Petrochemical industry
- Chemical industry
- Pharmaceutical industry
- Pulp and paper industry
- Food and beverage industry
- Sugar industry
- Covers
- Hatches
- Reactor vessels
- Process vessels
- Flange connections
- Pipe connections
- Maintenance seals

## Standards and approvals

- FDA 21CFR 177.1550
- TA-Luft
- BAM
- DVGW

## Notes

Not suitable for fluorine-hydrogens, fluorine compounds or molten alkali metals (except hydrofluorides).

## Variant

9655/RR (rings)

## Burachem Filled PTFE Gasket sheet – physical properties (typical, for gasket thickness 2.0 mm)

Material		Burachem B	Burachem R	Burachem W
Color		Blue	Brown	White
Filler		Glass, hollow microspheres	Silica	Barium sulphate
Tolerances – thickness		DIN 28091-1	DIN 28091-1	DIN 28091-1
Approvals		FDA/TA-Luft	DVGW/TA-Luft/BAM/FDA	DVGW/TA-Luft/BAM/FDA
Property	Standard			
Identification		TF – G – 0	TF – M – 0	TF – M – 0
Density	DIN 28 090-2	1.7	2.1	2.9
Tensile strength (Mpa)	DIN 52 910	16	17	18
Residual stress $\sigma_{DE/16}$ : 150 °C, 30 Mpa, 16 h	DIN 52 913	12	16	14
Compressibility (%)	ASTM F 36 J	25	5	3
Recovery (%)	ASTM F 36 J	40	45	45
Cold compressibility $\epsilon_{KSW}$ (%)	DIN 28 090-2	20	3	3
Cold recovery $\epsilon_{KRW}$ (%)	DIN 28 090-2	4	1	1
Hot creep $\epsilon_{WSW}$ (%)	DIN 28 090-2	45	20	40
Hot recovery $\epsilon_{WRW}$ (%)	DIN 28 090-2	6	3	4
Specific leakage rate	DIN 3535-6	$\leq 0.015 \text{ mg}/(\text{m}^2 \cdot \text{s})$	$\leq 0.015 \text{ mg}/(\text{m}^2 \cdot \text{s})$	$\leq 0.015 \text{ mg}/(\text{m}^2 \cdot \text{s})$
Specific leakage rate acc. to TA-Luft, Helium, 1 bar, 30 Mpa	VDI 2440/TA-Luft	$5.8 \cdot 10^{-6} \text{ mbar} \cdot \text{l}/(\text{s} \cdot \text{m})$	$5.4 \cdot 10^{-7} \text{ mbar} \cdot \text{l}/(\text{s} \cdot \text{m})$	$1.7 \cdot 10^{-6} \text{ mbar} \cdot \text{l}/(\text{s} \cdot \text{m})$
"m" factor – 1.5 mm (1/16") thickness	ASME	3.0	3.5	3.5
3.0 mm (1/8") thickness		3.5	4.0	4.0
"y" factor – 1.5 mm & 3.0 mm (1/16" & 1/8")	ASME	7 Mpa (1,015 PSI)	10 Mpa (1,450 PSI)	10 Mpa (1,450 PSI)

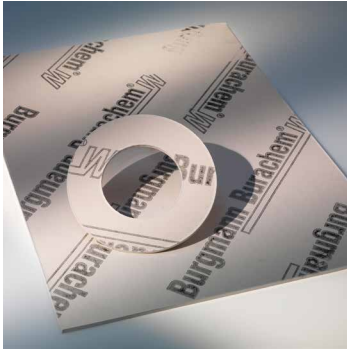

### Burachem White 9655/W

#### Features

PTFE-based gasket material, with barium sulphate filler.  
Cold-flow reduced PTFE-based gasket sheet with high mechanical strength and chemical resistance as well as optimized creep resistance.

#### Advantages

- Excellent chemical resistance
- Excellent mechanical resistance
- Very low gas leakage (complies with German Fugitive Emission Regulation TA-Luft)
- Minimized cold-flow and creep behavior
- High density makes this material ideal for gaskets in steel pipework and equipment where higher bolt loads are required
- No aging

#### Operating range

Pressure:  $p = \text{vacuum} \dots 83 \text{ bar}$   
Temperature:  $t = -210 \text{ }^\circ\text{C} \dots +260 \text{ }^\circ\text{C}$   
Chemical resistance:  $\text{pH} = 0 \dots 14$

Excellent media resistance throughout the complete pH range as well as against most concentrated acids.  
Not suitable for fluorine-hydrogens, fluorine compounds or molten alkali metals.

#### Forms of supply

Sheets 1,200 x 1,200 up to 1.0 mm thickness  
Sheets 1,500 x 1,500 from 1.5 mm thickness  
Standard thickness:  
1.0/1.5/2.0/3.0 mm  
Cut rings, complete or in segments

#### Recommended applications

- Process industry
- Petrochemical industry
- Chemical industry
- Pharmaceutical industry
- Pulp and paper industry
- Food and beverage industry
- Sugar industry
- Agitators
- Mixers
- Dryers
- Filters
- Refiners
- Covers
- Hatches
- Reactor vessels
- Process vessels
- Flange connections
- Pipe connections
- Maintenance seals

#### Standards and approvals

- FDA 21CFR 177.1550
- BAM ( $\text{O}_2$ ) 83 bar/250 °C
- TA-Luft

#### Variant

9655/WR (rings)

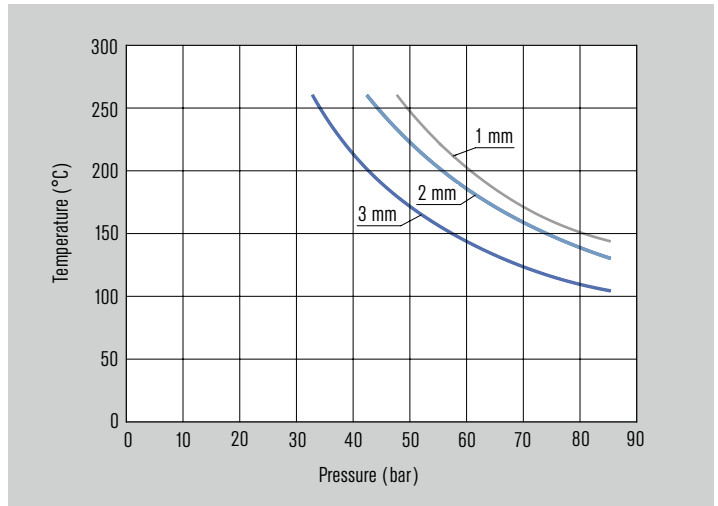

Pressure and temperature operating limits for Burachem with filler (Burachem 9655/B, W and R) as a function of seal thickness

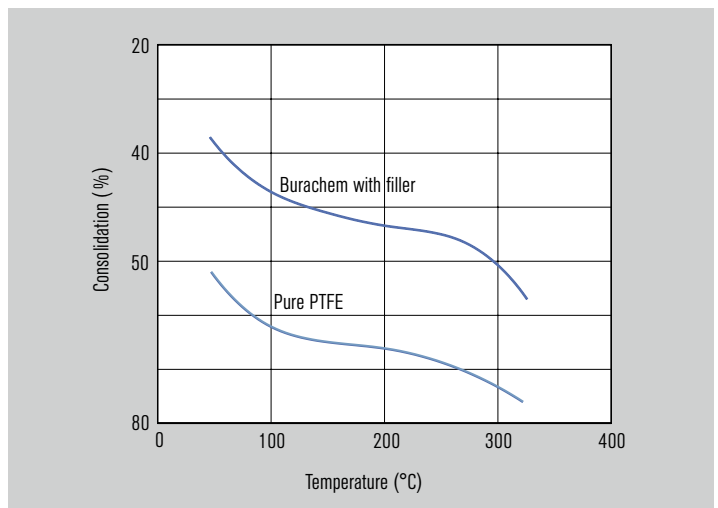

Consolidation and temperature of pure sintered PTFE compared to Burachem with filler (Burachem 9655/B, W and R). Contact pressure: 50 N/mm<sup>2</sup>, seal thickness: 2.0 mm

# PTFE gasket sheets

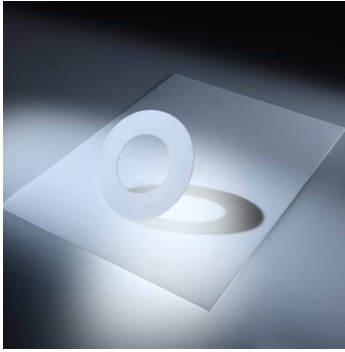

## Burachem P 9655

### Features

Sheet material made from 100 % virgin PTFE without added reinforcement or fillers. It is suitable for:

- Pipe flanges
- Heat exchangers
- Process equipment
- Pumps and agitator flanges
- Bearing pads

### Advantages

- Sheet material with no contamination risk
- Excellent surface conformability and low-friction properties

### Operating range

Temperature:  $t = -240\text{ °C} \dots +260\text{ °C}$ ,  
transient peak up to  $+315\text{ °C}$   
Chemical resistance:  $\text{pH} = 0 \dots 14$

### Pressure range

The pressure range depends on installation and working parameters – please refer to your local EagleBurgmann representative.

### Forms of supply

- Sheet size: 1,500 x 1,500 mm in 2 mm and 5 mm thickness
- Sheet size: 1,200 x 1,200 mm in 0.5 mm and 1.5 mm thickness
- Other measurements on request

### Recommended applications

- Process industry
- Petrochemical industry
- Chemical industry
- Pharmaceutical industry
- Pulp and paper industry
- Food and beverage industry
- Sugar industry
- Flange connections
- Pipe connections

### Standards and approvals

- Physiologically harmless under permanent operating temperature up to  $+260\text{ °C}$ , acc. to BG Nr. 21
- FDA 21

### Variant

9655/PR (cut gaskets)



## Burachem Multi 9654/MP

### Features

Burachem Multi ePTFE sheet material is made from 100 % virgin PTFE. Because of a special manufacturing technique the resulting material has a multi-directional fibrillized structure (ePTFE), which provides exceptional properties.

### Advantages

- PTFE gasket sheet with exceptional adaptability. This material shows almost no increase in width and simultaneously very low compressive creep even under extreme conditions. It has an outstanding residual stress for a PTFE gasket material
- No aging

### Operating range

Pressure:  $p = \text{vacuum} \dots 200\text{ bar}$   
Temperature:  $t = -240\text{ °C} \dots +270\text{ °C}$ ,  
short term up to  $+315\text{ °C}$   
Chemical resistance:  $\text{pH} = 0 \dots 14$

### Forms of supply

- Sheet size: 1,000 x 1,600 mm
- Thickness: 1.0/1.5/1.6/2.0/3.0/4.0/5.0/6.0 mm

### Variant

9654/MR (cut gaskets)

### Recommended applications

- Process industry
- Petrochemical industry
- Chemical industry
- Pharmaceutical industry
- Power plant technology
- Pulp and paper industry
- Food and beverage industry
- Sugar industry
- Resistant to all media, except diluted and molten alkali metals as well as elementary fluorine at  $t > 150\text{ °C}$  and  $p > 40\text{ bar}$
- Centrifugal pumps

- Mixers
- Dryers
- Filters
- Heat exchangers
- Hatches
- Reactor vessels
- Process vessels
- Flange connections

### Standards and approvals

- BAM ( $\text{O}_2$ )  $160\text{ °C}/40\text{ bar}$
- TA-Luft
- FDA 21 CFR 177.1550
- Physiologically harmless over long-term-temperature use up to  $+260\text{ °C}$ , acc. to BG Nr. 21
- In accordance with EN 1514-1 for thickness 2 mm
- Blow-out safety acc. to VDI 2200 class C

### Notes

Very easy on-site cutting or size-optimization with hand tools possible.

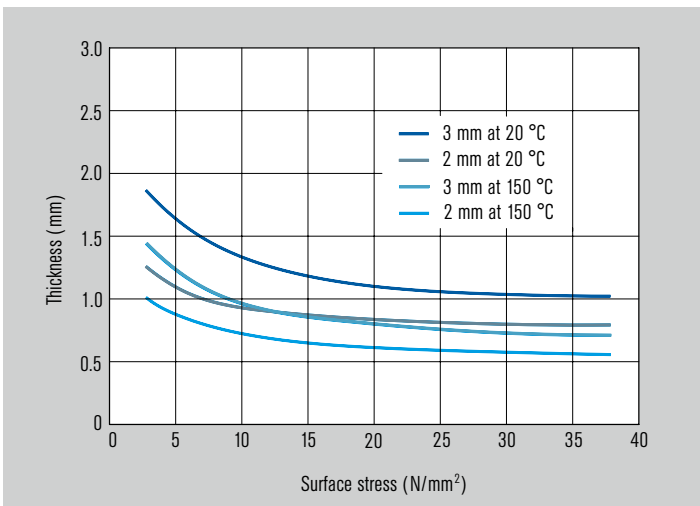

Burachem Multi 9654/MP – thickness on assembly

# PTFE sealants and tapes



**PTFE sealant tape 6725/L**

## Features

Concentrically woven pure PTFE filament yarn.

## Advantages

- Excellent surface conformability makes this ideal for vessel and pipe flanges with rough, uneven, or glass-lined surfaces
- Suitable for food industry
- Almost no PTFE cold flow

## Operating range

Pressure:  $p = 15$  bar  
 Temperature:  $t = -200$  °C ...  $+280$  °C  
 Chemical resistance: pH = 0 ... 14

## Recommended applications

- Process industry
- Petrochemical industry
- Chemical industry
- Water and waste water technology
- Building services industry
- Food and beverage industry
- Sugar industry
- Resistant to strong acids and alkalis, aggressive gases, solvents, foods, pharmaceuticals (not against molten alkali metals)
- Agitators
- Mixers
- Refiners
- Covers
- Hatches
- Process vessels
- Flange connections
- Maintenance seals

## Functional description

Endless connection by inserted-tongue fastener.

## Forms of supply

Width (mm)	Thickness (mm)	Weight (g/m)
10	3	50
20	4	145
25	5	225
35	6	375
50	7	700

As well as pre-cut by the meter



**TR PTFE/graphite sealant tape 6732**

## Features

PTFE/graphited carbon yarn braided into flat, dry (without additional impregnation), sealant tape.

## Advantages

- The high content of high-quality carbon yarns is very flexible and gentle to the sealing surface
- For vessel and pipe flanges with high levels of unevenness and/or enamelled surfaces

## Operating range

Pressure:  $p = 25$  bar  
 Temperature:  $t = -200$  °C ...  $+280$  °C  
 Chemical resistance: pH = 0 ... 14

## Forms of supply

Width (mm)	Thickness (mm)
10	3
20	3
25	4
35	5
50	6

Special sizes on request

## Recommended applications

- Process industry
- Petrochemical industry
- Chemical industry
- Pulp and paper industry
- Water and waste water technology
- Sugar industry
- Resistant to strong acids and alkalis, aggressive gases, solvents, (not suitable for liquid alkali metals)
- Covers
- Hatches
- Flange connections
- Maintenance seals

## Standards and approvals

BAM approval for oxygen  $+40$  °C at 65 bar up to  $+200$  °C at 50 bar.



**PTFE cord 9660**

## Features

Cord made from twisted pure PTFE with reduced cold flow due to special production procedure.

## Advantages

Suitable for valve spindles and flanges in chemical, pharmaceutical and food industry.

## Operating range

Pressure:  $p = 105$  bar  
 Temperature:  $t = -200$  °C ...  $+280$  °C  
 Chemical resistance: pH = 0 ... 14

## Forms of supply

Diameter: 2.5 mm; roll: 15 m  
 Diameter: 3.2 mm; roll: 15 m  
 Diameter: 4.0 mm; roll: 10 m  
 Diameter: 6.0 mm; roll: 15 m  
 Diameter: 8.0 mm; roll: 5 m  
 Diameter: 10 mm; roll: 5 m

## Recommended applications

- Process industry
- Petrochemical industry
- Chemical industry
- Pharmaceutical industry
- Pulp and paper industry
- Water and waste water technology
- Food and beverage industry
- Sugar industry
- Flange connections
- Maintenance seals

## Standards and approvals

BAM Tgb.-No. 10570/840 for oxygen of 50 bar at 100 °C or of 30 bar at 200 °C

## Notes

Flanges will be sealed quickly and effectively by laying the round PTFE cord (twist ends together) in a ring around the flange surface.

# PTFE sealants and tapes



## Quick-Seal MB4 9654/MB4

### Features

Sealant tape made of 100 % virgin, expanded PTFE manufactured by a special process giving the tape a multi-directional fiber structure with a self-adhesive strip on one side. EagleBurgmann Quick-Seal MB4 is currently the first and only multi-directional ePTFE tape with approval and certification according to TRD 401/VdTÜV-Instruction Seal 100 and is especially adapted to the needs of inspection hole and manhole connections.

### Advantages

The manufacturing process enhances characteristics like extremely low compressive creep or increase in width even under extreme conditions. Additionally to its wide thermal and chemical application range, the tape shows outstanding sealability for cold water testing and during normal operating conditions. The tape is ideal for plant standardization.

### Operating range

Temperature:  $t =$  approved up to 250 °C  
 Pressure:  $p =$  approved up to 40 bar steam and 88 bar water  
 Chemical resistance: pH = 0 ... 14

### Forms of supply

- Supply as tape by the meter, with self-adhesive strip for easy installation, on rolls of 10 or 25 m
- Tape size: 15 x 6 mm

### Recommended applications

- Power plant technology
- Water and waste water technology
- Building services industry
- Resistant to all media, except diluted and molten alkali metals as well as elementary fluorine at  $t > 150$  °C and  $p > 40$  bar
- Covers
- Hatches
- Flange connections
- Pipe connections
- Maintenance seals

### Standards and approvals

- Approved up to 40 bar operating pressure
- TÜV
- TRD 401

### Notes

No danger of confusion because one tape could be used for all types of vessels and lids. With the self-adhesive strip on one side, the tape is easy to install. To get a seal, the tape should be cut with an angle at one end. If possible start at bolt hole. Then the tape can be stuck around the flange in the middle of the sealing surface. To close the ends, the tape should again be cut with an angle and overlapped with the start point.



## Burachem MMH 9654/MMH

### Features

These safety-gasket rings made from multi-directional expanded PTFE are manufactured to meet the requirements of end-users for safety, tightness and reliability. This gasket is especially designed for use as handholes, headholes, manholes and all kind of inspection ports in vessels and boilers. According to Germany's law an approval according to TRD 401/VdTÜV-Instruction Seal 100 is available.

### Advantages

This gasket material made from 100 % virgin and expanded PTFE is free from deterioration and physiologically harmless. Universally applicable, these gaskets have high adaptability and operating safety meeting test category D.

### Operating range

Pressure:  $p =$  approved up to 40 bar operating pressure, cold water test pressure: 88 bar  
 Temperature:  $t =$  approved up to 240 °C

### Forms of supply

Ready to install rings in the following sizes:  
 80 x 120 x 15 x 6 mm  
 100 x 150 x 15 x 6 mm  
 115 x 165 x 15 x 6 mm  
 150 x 200 x 15 x 6 mm  
 220 x 320 x 25 x 6 mm  
 300 x 400 x 25 x 6 mm  
 320 x 420 x 25 x 6 mm  
 350 x 450 x 25 x 6 mm  
 Other measurements on request.

### Recommended applications

- Building services industry
- Water and waste water technology
- Power plant technology
- Resistant against all medias at the range pH 0 to 14 excepting molten alkali metals, in particular resistant to boiler feed water according to TRD 611
- Reactor vessels
- Process vessels
- Hatches

### Standards and approvals

- TÜV
- TRD 401

### Notes

The very high adaptability during installation ensures exceptional cold water tightness. The previously needed high installation effort when using a rubber or fiber-based gasket for the cold water pressure test is no longer necessary.

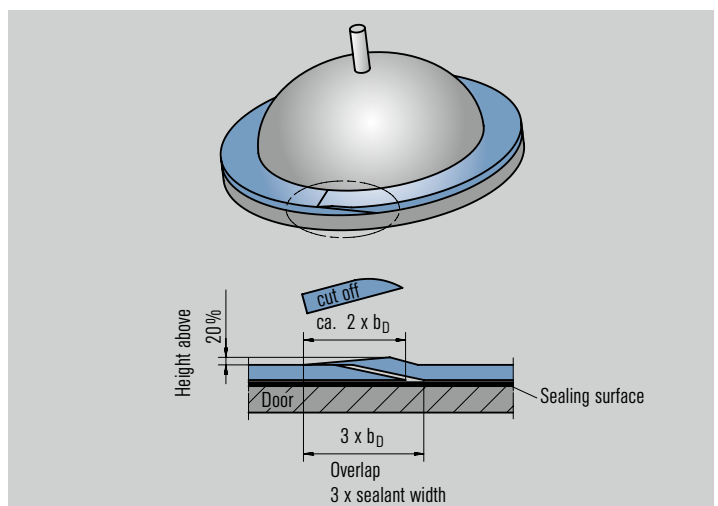

Assembly with sloping cut – Burachem MMH 9654/MMH



### Elastic Tankpak 6756

#### Features

The EagleBurgmann Elastic Tankpak is an excellent gasket for container in use to transport chemicals or solvents. The core is made from an elastic hollow tubular EPDM rubber and is wrapped by the first layer of PTFE foil. Thereby the chemical resistance of the gasket is significantly upgraded. The intermediate layer made from polypropylene yarn is mainly a kind of cushion. With wrapped PTFE foil the main resistance against the medium will be achieved. The entire seal is then overbraided with PTFE yarn.

#### Advantages

With the Elastic Tankpak EagleBurgmann offers a re-usable gasket for container and other lid gaskets which offers a very good chemical resistance and a high stability at the same time as a good abrasion resistance. This sealing cord offers a high recovery characteristic and is perfectly usable for periodic opening and closing of those lids. In case of using glass fiber as intermediate layer for the cushion the product variant TG is as well usable for higher temperatures.

#### Operating range

Pressure:  $p = 0.7$  bar  
Temperature:  $t = -50$  °C ...  $+100$  °C,  
( $250$  °C for 6756/TH)  
Chemical resistance: pH = 0 ... 14

#### Forms of supply

10 ... 60 mm square/rectangular cross-section lengths (meters) or endless rings to suit application.

#### Recommended applications

- Chemical industry
- Shipbuilding
- Acids, alkalis, oils, organic solvents, fluent fluent and powderlike chemicals
- Suitable for IMO class 2 and 3 chemical cargos
- Covers
- Hatches

#### Standards and approvals

- DNV, USCG (PO2/1,2 butylene oxide)
- Germanischer Lloyd

#### Notes

Cover design and seal installation. The cover should be designed to accommodate a gasket of not too large a cross-section. With rectangular cross-sections the ratio of width x height should be 3:2. The contact pressure exerted by the cover on the gasket should be adequate and as evenly distributed as possible around the circumference. It is advisable to fit several toggles/clamps around the periphery. The contact surface for the gasket on the coaming should be wide enough and sufficiently rounded to avoid damaging the gasket surface.

#### Variants

- 6756/TG: EPDM core/Polypropylene/PTFE
- 6756/TH: Elastomer core/Glass fiber/PTFE

# PTFE sealants and tapes



## Quick-Seal Universal F 9654/UF

### Features

Self-adhesive sealant tape made from 100 % Teflon® PTFE. The production process creates a micro-porous, mono-directional fiber structure (ePTFE), that gives the seal its special properties. Universal 100 % virgin PTFE flange sealant tape which has:

- Expanded microcellular structure
- Very good adaptability
- Easy to install – tape has adhesive backing to fix into position

### Advantages

- The sealant tape, self-adhesive on one side, shows the highest adaptability of all PTFE seals. The adhesive strip protected by a masking paper on the rectangular seal face makes fixing the sealing tape to the flange surface very easy and simple
- Extremely easy to handle and applicable almost anywhere for all kinds of flange styles, sizes and construction shapes

### Operating range

Temperature:  $t = -240\text{ °C} \dots +270\text{ °C}$ , transient peak up to  $+315\text{ °C}$   
 Chemical resistance:  $\text{pH} = 0 \dots 14$

### Forms of supply

Supplied on rolls, in lengths of 5, 10, 25 and 50 m.

Width (mm)	Height (mm)
3	1.5
5	2
7	2.5
10	3
12	4
14	5
17	6
20	7
28	5
40	5

### Recommended applications

- Process industry
- Petrochemical industry
- Chemical industry
- Pharmaceutical industry
- Pulp and paper industry
- Water and waste water technology
- Mining industry
- Building services industry
- Food and beverage industry
- Sugar industry
- Resistant to all media, except diluted and molten alkali metals as well as elementary fluorine at  $t > 150\text{ °C}$  and  $p > 40\text{ bar}$
- Agitators
- Mixers
- Dryers
- Filters
- Refiners
- Heat exchangers
- Covers
- Hatches
- Reactor vessels
- Process vessels
- Flange connections
- Maintenance seals

### Standards and approvals

- BAM ( $\text{O}_2$ ) up to 100 bar/90 °C
- DVGW up to 16 bar
- FDA 21

### Notes

The pressure resistance depends only on installation and operating conditions. Please check our installation and maintenance instructions. With the self adhesive strip on one side, the tape is easy to install. The sealant tape is not subject to aging. The adhesive life depends on the storage and installation conditions.

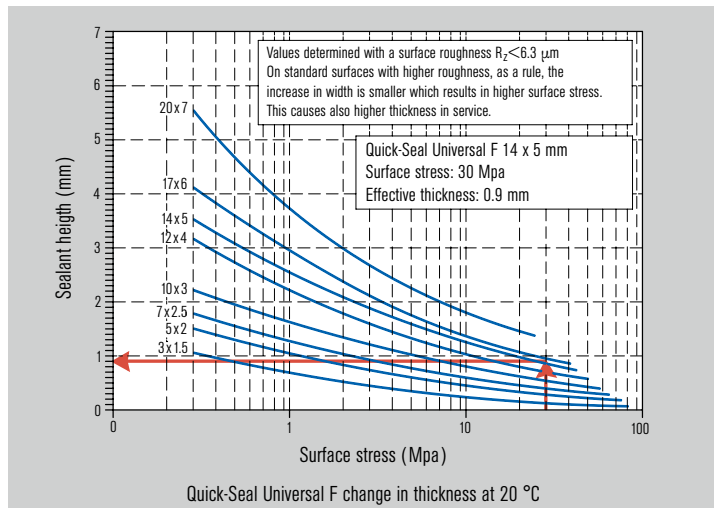
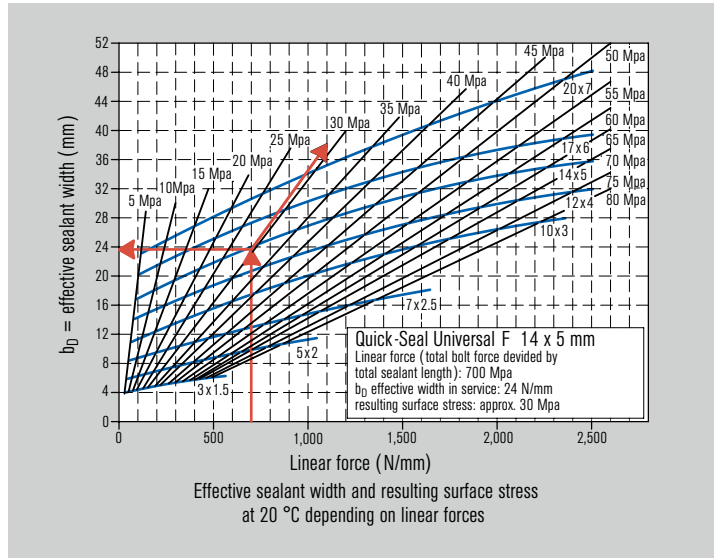

Change in thickness at 20 °C

### Seal selection and installation dimension recommendation

The correct choice of the seal's dimension depends on factors like width and composition of the sealing surface, on construction of flanges and bolts as well as on the existing operating conditions. Rule of thumb: Seal width should be approx. 1/4 to 1/3 of the sealing surface width.



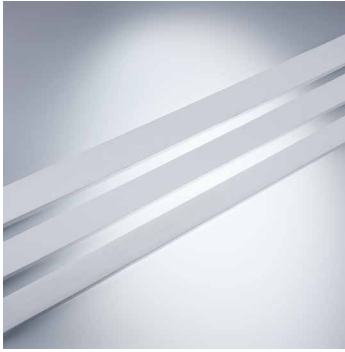

### Quick-Seal Multi 9654/MB

#### Features

PTFE gasket tape with high adaptability and stability for extreme requirements such as fragile equipment, large diameter steel flanges with considerable unevenness or very rough surfaces. ePTFE material is distinguished by high adaptability and simultaneously low cold flow as well as a high dimensional stability. The high bi-axial strength also provides high residual stress.

#### Advantages

Sealant tape of 100 % pure, virgin PTFE with self-adhesive strip on the rear face. Because of the special manufacturing technique the result is a multi-directional fibrillized structure (ePTFE), which demonstrates extraordinary properties.

#### Operating range

Pressure (p): the pressure resistance depends only on installation and operating conditions. Please check our installation and maintenance instructions.

Temperature:  $t = -240\text{ °C} \dots +270\text{ °C}$ , transient peak up to  $+315\text{ °C}$

Chemical resistance:  $\text{pH} = 0 \dots 14$

#### Forms of supply

Width: 10 ... 65 mm

Thickness: 2/3/6/9 mm

Supplied in rolls

#### Recommended applications

- Process industry
- Petrochemical industry
- Chemical industry
- Pharmaceutical industry
- Pulp and paper industry
- Food and beverage industry
- Sugar industry
- Resistant to all media, except diluted and molten alkali metals as well as elementary fluorine at  $t > 150\text{ °C}$  and  $p > 40\text{ bar}$
- Heat exchangers
- Covers
- Hatches
- Reactor vessels
- Process vessels
- Maintenance seals

#### Standards and approvals

- TA-Luft
- FDA 21 CFR 177.1550
- Physiologically harmless over long-term temperature use up to  $+260\text{ °C}$ , according to BG Nr. 21
- In accordance with EN 1514-1 for thickness 2 mm
- Blow-out safety according to VDI 2200 class C

#### Notes

Easy installation on-site including cutting to length or adjustment by hand. Severe unevenness can be levelled by layering and/or shimming. No holding time, no cure time required. No aging of the sealing tape. The adhesion depends on storage and installation conditions.

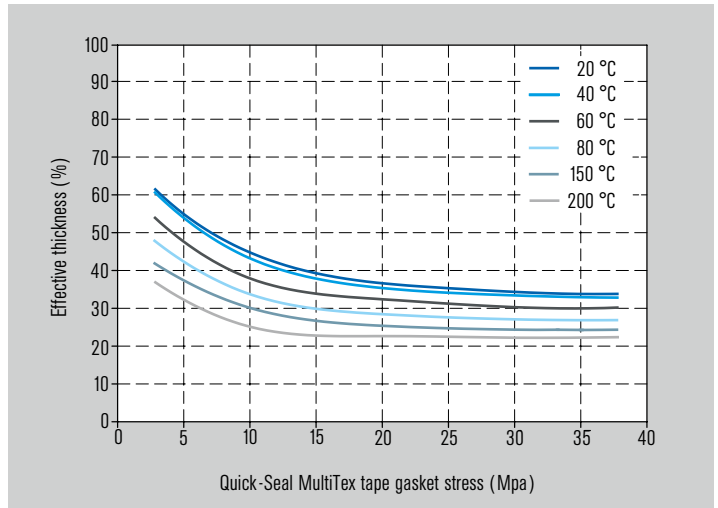

#### Characteristic values

AD-Guidelines B7:

$$K_D \times K_D = 25 \times b_D$$

$$K_1 = 2.5 \times b_D$$

DIN 28090-1/prEN 13555:

$$\sigma_{vu(TA-Luft)} / Q_{MIN(TA-Luft)} = 30\text{ Mpa}$$

$$\sigma_{vu(40\text{ bar; }001)} / Q_{MIN(0, 01)} = 25\text{ Mpa}$$

$$\sigma_{vu(10\text{ bar; }001)} / Q_{MIN(0, 01)} = 20\text{ Mpa}$$

$$\sigma_{vu(\text{class C})} / Q_{S\text{ MIN}(\text{class C})} = 10\text{ Mpa}$$

$$\sigma_{bv} / Q_{S\text{ MIN}(0, 01)} = 5\text{ Mpa}$$

$$\sigma_{vd} / Q_{CRIT} = 180\text{ Mpa}$$

DIN 28090-2:

$$\epsilon_{KSW} = 39\%$$

# PTFE sealants and tapes



**Quick-Seal Blue 9655/BBC**

## Features

Sealant tape of microcellular expanded PTFE, filled with hollow glass microspheres giving great material flexibility.

- Very good flexibility
- High resilience ability
- High chemical resistance
- Good creep and cold flow properties
- Dimensionally stabilized

## Advantages

Universal seal for reliable and economic sealing of plastic and fragile equipment flanges.

The self-adhesive tape is very suitable to produce seals in any shape on-site.

Preparation, delivery time and expensive waste in using cut gaskets is avoided.

- Universally applicable
- High tightness
- Reduction of shut down times
- Quick and easy installation
- No scrap
- Reduction of total costs

## Operating range

Pressure (p): the pressure resistance depends only on installation and operating conditions.

Temperature:  $t = -240\text{ °C} \dots +270\text{ °C}$ , transient peak up to  $+315\text{ °C}$

Chemical resistance:  $\text{pH} = 0 \dots 14$

Recommended operation limits:

$-200\text{ °C} \dots +200\text{ °C}$ , with simultaneously permitted over-pressure

## Forms of supply

- Supplied by the meter, on rolls with lengths of 10, 25 or 50 m
- 9 x 3 mm
- 14 x 3 mm
- 19 x 3 mm

## Recommended applications

- Process industry
- Petrochemical industry
- Chemical industry
- Pharmaceutical industry
- Food and beverage industry
- Sugar industry
- Universally resistant, except HF, H<sub>3</sub>PO<sub>4</sub>, concentrated alkalis, diluted and molten alkali metals as well as elementary fluorines at higher temperatures and pressures
- Heat exchangers
- Covers
- Hatches
- Reactor vessels
- Process vessels
- Maintenance seals

## Standards and approvals

- FDA US 21 CFR 177.1550

## Notes

With self-adhesive strip on one side, the tape is easy and quick to install.



**Quick-Seal Brown 9655/RBC**

## Features

Sealant tape of microcellular expanded PTFE, filled with quartz, with high residual thickness when installed.

- Very good flexibility
- High resilience ability
- High chemical resistance
- Good creep and cold flow properties
- Dimensionally stabilized

## Advantages

Universal seal for reliable and economic sealing of ring-shaped or angled flanges, e.g. pressure vessels or heat exchangers.

The self-adhesive tape sold by the meter is very suitable to produce seals in any shape on-site. Preparations, delivery time and expensive waste (in case of punched gaskets) are not applicable.

- Universally applicable
- High tightness
- Reduction of shutdown times
- Quick and easy installation
- No scrap
- Reduction of total costs

## Operating range

Pressure (p): the pressure resistance depends only on installation and operating conditions.

Temperature:  $t = -240\text{ °C} \dots +270\text{ °C}$ , transient peak up to  $+315\text{ °C}$

Chemical resistance:  $\text{pH} = 0 \dots 14$

Recommended operation limits:

$-200\text{ °C}$  up to  $+200\text{ °C}$ , with simultaneously permitted over-pressure

## Forms of supply

- By the meter, on rolls with lengths of 10, 25 or 50 m
- 9 x 3 mm
- 14 x 3 mm
- 19 x 3 mm

## Recommended applications

- Process industry
- Petrochemical industry
- Chemical industry
- Pharmaceutical industry
- Pulp and paper industry
- Food and beverage industry
- Sugar industry
- Universally resistant, except HF, H<sub>3</sub>PO<sub>4</sub>, concentrated alkalis, diluted and molten alkali metals as well as elementary fluorines at higher temperatures and pressures
- Agitators
- Mixers
- Dryers
- Filters
- Refiners
- Heat exchangers
- Covers
- Hatches
- Reactor vessels
- Process vessels
- Flange connections
- Pipe connections
- Maintenance seals

## Standards and approvals

- FDA US 21 CFR 177.1550

## Notes

With the self-adhesive strip on one side, the tape is easy and quick to install. The closing joint is easily made with a knife.

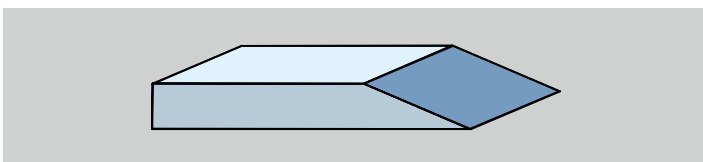

Figure 1

## Minimize installation and maintenance downtime!

The self-adhesive backing makes Quick-Seal CellFlon gasket tape easy to install. Completely clean the sealing surfaces and remove any dirt, corrosion, oil or material from the previous gasket. Cut the first end of the gasket tape using a sloping cut as shown in Fig. 1.

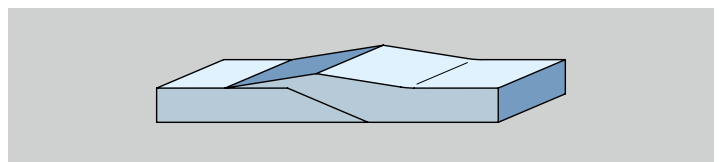

Figure 2

Remove the protective paper and start next to a bolt hole – sticking the tape at the center of the sealing surface. Stick the gasket tape around the flange circumference and close the gasket using a second sloping cut for the ending. (See Fig. 2.) The length of the overlap must be as a minimum equal to the tape width.



### Quick-Seal White 9655/WBC

#### Features

Sealant tape of microcellular expanded PTFE, without fillers for highest chemical resistance.

- Good flexibility
- High resilience ability
- High chemical resistance
- Good creep and cold flow properties
- Dimensionally stabilized

#### Advantages

Universal seal for reliable and economic sealing of plastic flanges and equipment flanges.

The self-adhesive tape is very suitable to produce seals in any shape on-site. Preparation, delivery time and expensive waste in using cut gaskets are not applicable.

- Universally applicable
- High tightness
- Reduction of shutdown times
- Quick and easy installation
- No scrap
- Reduction of total costs

#### Operating range

Pressure (p): the pressure resistance depends only on installation and operating conditions.

Temperature:  $t = -240\text{ °C} \dots +270\text{ °C}$ , transient peak up to  $+315\text{ °C}$

Chemical resistance:  $\text{pH} = 0 \dots 14$

Recommended operation limits:  $-200\text{ °C} \dots +200\text{ °C}$ , with simultaneously permissible over-pressure

#### Forms of supply

- Supplied by the meter, on rolls with lengths of 10, 15 or 50 m
- 9 x 3 mm
- 14 x 3 mm
- 19 x 3 mm

#### Recommended applications

- Process industry
- Petrochemical industry
- Chemical industry
- Pharmaceutical industry
- Pulp and paper industry
- Food and beverage industry
- Sugar industry
- Universally resistant, except HF, H<sub>3</sub>PO<sub>4</sub>, concentrated alkalis, diluted and molten alkali metals as well as elementary fluorines at higher temperatures and pressures
- Covers
- Hatches
- Reactor vessels
- Process vessels
- Flange connections
- Pipe connections
- Maintenance seals

#### Standards and approvals

- FDA US 21 CFR 177.1550

#### Notes

With the self-adhesive strip on one side, the tape is easy and quick to install.

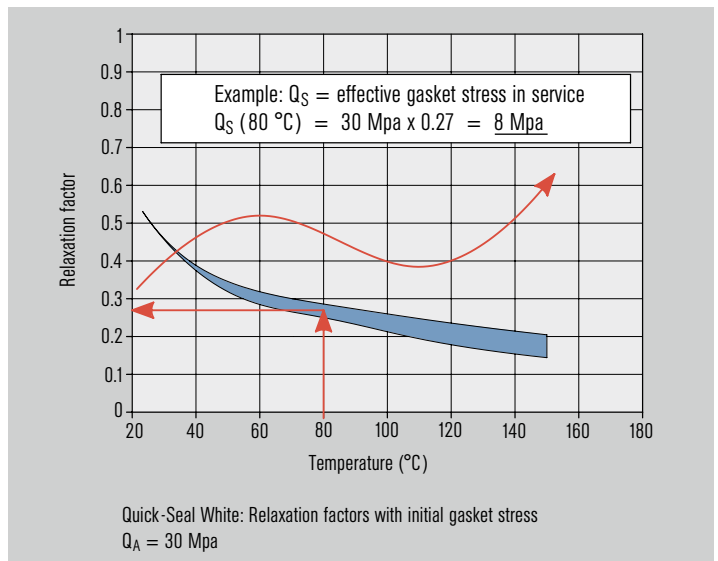
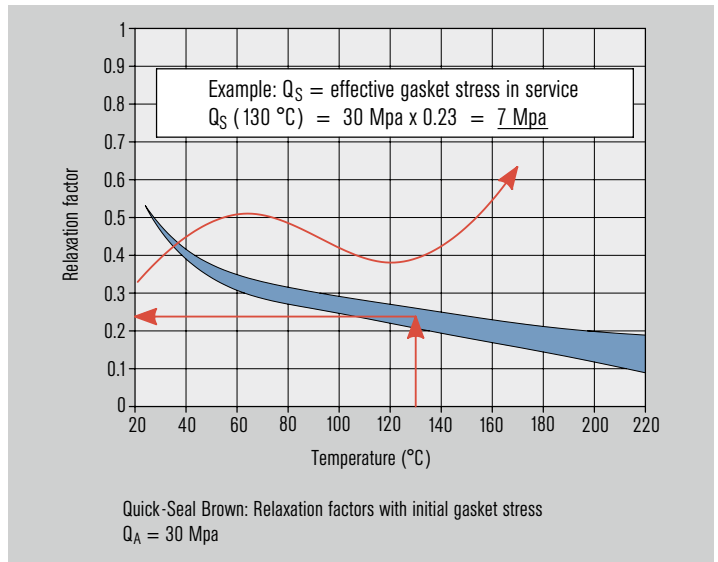
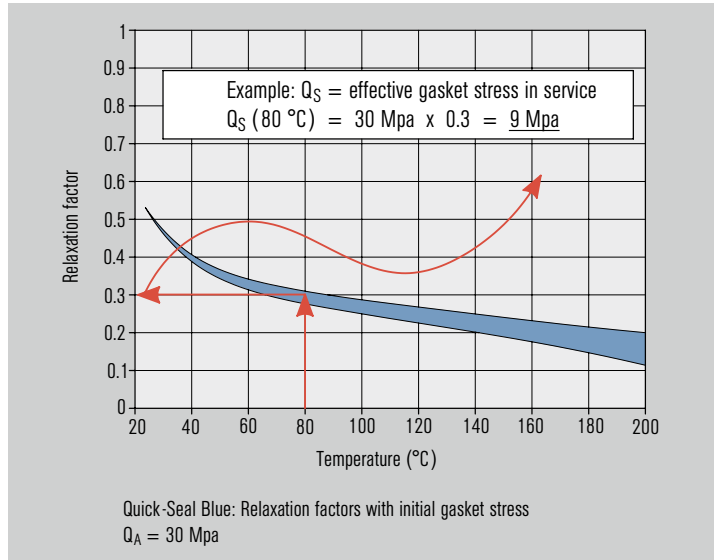

Quick-Seal CellFlon gasket tape is the optimum way to reduce maintenance downtime and reduce both gasket and installation costs. It is the ideal way to manufacture large diameter gaskets or complex shapes directly in-situ. Using Quick-Seal CellFlon gasket tape does not require customized expensive cut or segmented gaskets.

# Graphite gasket sheets

All Statotherm products are manufactured from expanded natural graphite which has been carefully selected and produced specifically for sealing applications. The raw graphite is first processed to introduce chemical salts into its molecular structure. These salts are then re-converted into pure graphite using a thermo-shock treatment. The result is the formation of "worms" of graphite loosely held together. Consequently, the graphite is now up to 38 times larger volumetrically allowing it to be subsequently pressed or molded more easily. These molded shapes are permanently elastic and can be formed without the use of binders. Statotherm and Spiraltherm sealing products produced from this material have proven to be long-lived and reliable under extreme conditions of pressure and temperature throughout industry for many years.

## Advantages and properties of EagleBurgmann Statotherm graphite

- Practically no maintenance required
- Permanently elastic, especially in hot/cold thermal cycling
- No hardening or aging due to absence of binders
- Very good conformance to surface irregularities and unevenness through high level of adaptability
- Permanent resilience, approximately 10 % of pre-stressed seal thickness
- Fire safe tested, up to +900 °C (transient peak)
- Tested at low temperatures down to -196 °C
- Good thermal conductivity
- Good handling – easy to cut or punch
- High pressure resistance – depending upon seal design – up to 1,000 bars
- High temperature resistance: -200 °C up to 550 °C (+3,000 °C in a reducing or inert environment)
- High chemical resistance: pH 0 to 14

The performance and service life of a graphite seal is influenced by many factors such as seal design, operating cycle, installation procedures, etc. However, the most critical factors are the effects of graphite impurities leading to metal component corrosion and exposure to oxygen which accelerates volume loss of the sealing element.

Statotherm products are manufactured using only high-quality graphite which has strictly controlled quality requirements. Where necessary, corrosion inhibitors are added to enhance service life and protect equipment. For more details and to select the most suitable grade for your applications, please contact your local EagleBurgmann representative.

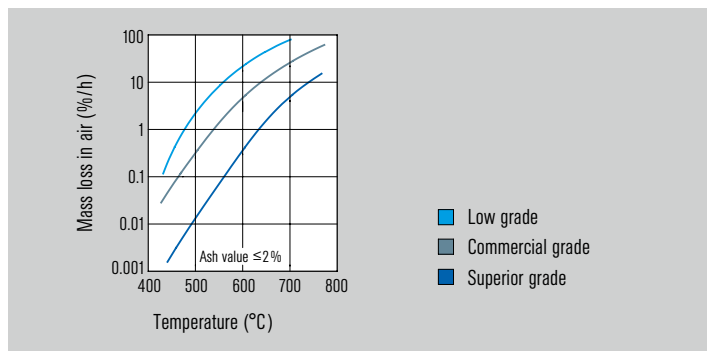

Mass loss of different quality graphites

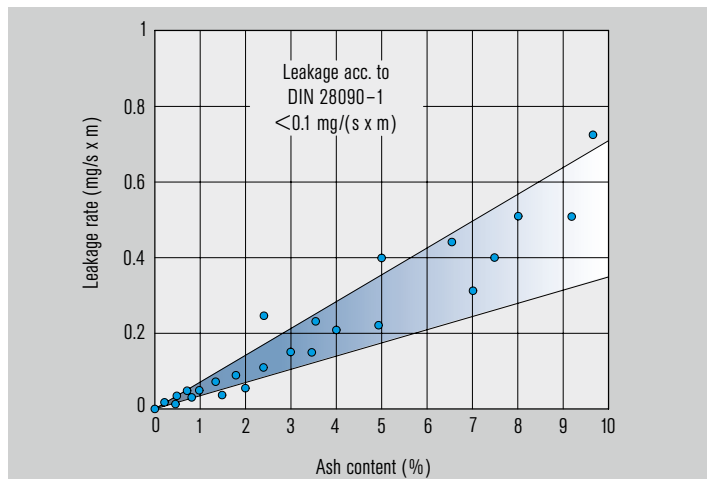

Expanded graphite: impact of ash content upon leakage performance

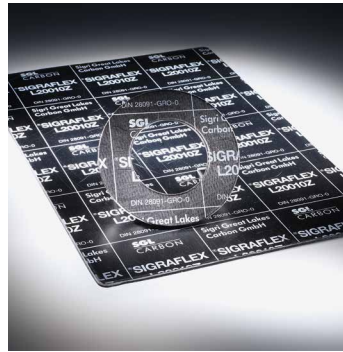

Statotherm P foil 9591/P

## Features

Gasket sheet material of flexible graphite, purity >99.85 % and low ash content. The soft and flexible material can compensate for uneven surfaces.

## Advantages

- Statotherm foil is the basic gasket material without measurable cold or warm flow and therefore applicable for all branches of industry as the gasket material for valves and pumps, for emergency service and special applications
- Statotherm has a good resistance to chemicals, an excellent performance with temperature cycling and a high stability under pressure

## Operating range

Pressure:  $p = 60$  bar  
 Temperature:  $t = -200$  °C ... +500 °C, steam: +550 °C  
 Chemical resistance: pH = 0 ... 14

## Forms of supply

- Sheet size: 1,000 x 1,000 mm
- Thickness: 0.5/1.0/1.5/2.0 mm
- According to drawing, measurements or other agreements

## Recommended applications

- Process industry
- Oil and gas industry
- Petrochemical industry
- Chemical industry
- Power plant technology
- Water and waste water technology
- Building services industry
- Shipbuilding
- Metal production and processing
- Centrifugal pumps
- Piston pumps
- Compressors
- Blowers
- Valves
- Heat exchangers
- Covers
- Flange connections
- Maintenance seals

## Standards and approvals

- DVGW
- BAM (O<sub>2</sub>)

## Notes

For installation only use dry and undamaged gaskets. Wet graphite gaskets should be installed after complete drying.

## Variant

9591/R (rings, gaskets)

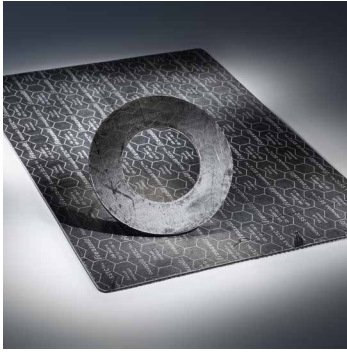

**Statotherm SSTC-TAL 9592/P**

**Features**

High-quality gasket sheet made of expanded graphite and a layer of expanded metal. It covers the whole spectrum of classic gasket materials. This material is universally applicable in all areas of industry and maintenance engineering. The sealing material – expanded graphite >99 % (graduated density) with an acid-resistant expanded metal inlay of chromium-nickel-steel (1.4404) – forms a three-dimensional structure when under load. Without any binder or filler, silicon-free.

**Advantages**

- Good solution for applications, where aggressive media, high temperatures and high pressures occur simultaneously. Additionally, appropriate for low surface pressure or narrow web width
- Generally suitable for all applications under extreme conditions, even under cycling loads
- Especially designed to meet the TA-Luft requirements (IPPC-directive). Suitable, e.g. in petrochemical and chemical industry or plant engineering, as well as for flanges in old equipment due to the excellent adaptability and flexibility. Very good for standardization
- Conforms to requirements of TA-Luft (VDI-Guideline 2440) of 10-4 mbar x l/s x m leakage at 30 Mpa

**Operating range**

Pressure: p = 200 bar  
 Temperature: t = -240 °C ...+550 °C  
 Chemical resistance: pH = 0 ... 14

**Forms of supply**

- Sheet size: 1,000 x 1,000 mm; 1,500 x 1,500 mm
- Thickness: 1.0/1.6/2.0/3.0 mm
- As well as rings with and without inner eyelet

**Recommended applications**

- Process industry
- Oil and gas industry
- Petrochemical industry
- Chemical industry
- Pharmaceutical industry
- Power plant technology
- Resistant to almost all organic and inorganic acids, alkalis, oils and solvents
- Heat exchangers
- Covers
- Reactor vessels
- Process vessels
- Flange connections
- Maintenance seals

**Standards and approvals**

- TA-Luft
- Fire safe (API 607/BS6755)
- BAM (O<sub>2</sub>: 200 °C/130 bar)
- DVGW
- 300 °C: 140 Mpa
- Blow-out safety according to VDI 2200 class C

**Notes**

- DIN 28091-4: GR-10-I-1M-Cr
- No aging

**Variants**

- 9592/R (rings)
- 9592/G (rings with eyelet)

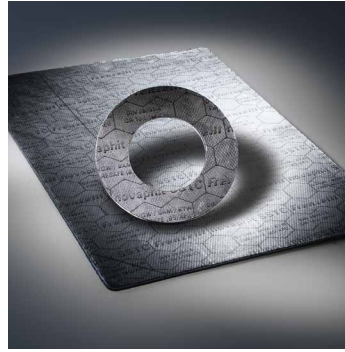

**Statotherm SSTC 9592/MP**

**Features**

Reinforced gasket sheet made of impregnated graphite >98 % with adhesive-free inlay of expanded metal (1.4404).

**Advantages**

Graphite gasket sheet with special reinforcement of expanded metal. Seals made from this graphite sheet material show outstanding performance due to the expanded metal inlay contributing significantly to the sealing effect. It is superior to all other graphite sheets and therefore is excellent choice for plant standardization.

**Operating range**

Pressure: p = 200 bar  
 Temperature: t = -240 °C ... +500 °C  
 Temperature limit for steam: +550 °C  
 Chemical resistance: pH = 0 ... 14

**Forms of supply**

- Sheets 1,000 x 1,000 mm
- Thickness: 1.0/1.5/2.0/3.0 mm
- According to drawing, measurements or other agreements

**Recommended applications**

- Process industry
- Oil and gas industry
- Petrochemical industry
- Chemical industry
- Pharmaceutical industry
- Power plant technology
- Pulp and paper industry
- Water and waste water technology
- Mining industry
- Building services industry
- Food and beverage industry
- Shipbuilding
- Sugar industry
- Metal production and processing
- Resistant to almost all organic and inorganic acids, alkalis, oils and solvents
- Heat exchangers
- Covers
- Reactor vessels
- Process vessels
- Flange connections
- Pipe connections
- Exhaust ducting
- Furnaces

**Standards and approvals**

- DVGW
- KTW
- Fire safe (API 607/BS6755)
- BAM (O<sub>2</sub>: 200 °C/130 bar)

**Variant**

(Former article number 9593/MP)  
 9592/MR (rings, gaskets)

**ASME “m” and “y” factors**

Product	Pressure (bar)	Thickness (mm)	m	y (Mpa)	y (PSI)	
Statotherm SSTC	10	1.0	2.5	10	1,450	
		1.5		10	1,450	
		2.0		10	1,450	
		3.0		25	3,625	
	16	1.0	2.5	10	1,450	
		1.5		10	1,450	
		2.0		10	1,450	
	25	3.0	2.5	34	4,930	
		1.0		10	1,450	
		1.5		11	1,595	
	40	2.0	2.5	12	1,740	
		3.0		47	6,815	
		1.0		10	1,450	
	80	1.5	2.5	14	2,030	
		2.0		17	2,465	
		3.0		50	7,250	
	Statotherm SSTC-TAL	10	1.0	2.5	20	2,900
			1.5		25	3,625
2.0			27		3,915	
Statotherm SSTC-TAL	10	1.6	2.5	75	10,875	
				10	1,450	
				10	1,450	
				12	1,740	
Statotherm SSTC-TAL	10	1.6	2.5	18	2,610	
				25	3,625	

# Graphite gasket sheets

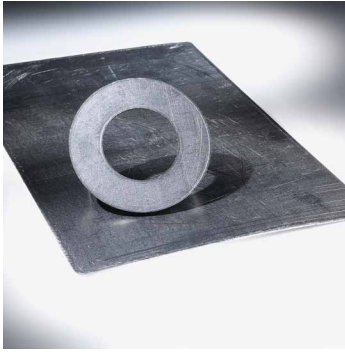

## Statotherm 1P 9593/1P

### Features

Graphite-based gasket sheet made from flexible graphite (>98 %) bonded to smooth stainless steel foil (316 L; 0.05 mm thickness).

### Advantages

Statotherm 1P is a gasket sheet material with a highly adaptive graphite layer allowing its use at low surface pressures or with weak flanges. This graphite gasket sheet stands out because of:

- No aging, no altering of structure
- Long-term stability of compression and recovery
- Exceptional oxidation resistance

### Operating range

Pressure:  $p = 40$  bar  
 Temperature:  $t = -200$  °C ...  $+400$  °C at inert ambiance or steam: up to  $+500$  °C  
 Chemical resistance:  $pH = 0$  ...  $14$

### ASME "m" and "y" factors

Product	m	y (Mpa)	y (PSI)
Statotherm 9591/P	2.00	10.30	1,500
Statotherm 9593/1P	2.00	10.30	1,500
Statotherm HDP 9593/HDP	2.50	20.70	3,000
Statotherm S6P 9593/S6P	2.50	13.80	2,000

### Forms of supply

- Sheet size: 1,000 x 1,000 mm
- Thickness: 0.55/0.75/1.0/1.5/2.0/3.0 mm
- According to drawing, measurements or other agreements

### Recommended applications

- Process industry
- Petrochemical industry
- Chemical industry
- Power plant technology
- Resistant to almost all organic and inorganic acids, alkalis, oils and solvents
- Centrifugal pumps
- Piston pumps
- Compressors
- Valves
- Heat exchangers
- Covers
- Flange connections
- Maintenance seals

### Standards and approvals

- DVGW
- BAM approval 200 °C/130 bar

### Notes

For a safe installation use dry and undamaged gaskets. Wet graphite gaskets should be installed after complete drying.

### Variants

- 9593/1R (rings, gaskets)
- 9593/1S (segments)



## Statotherm HDP 9593/HDP

### Features

Reinforced, multi-layer gasket sheet made of 0.5 mm thick layers of high-grade, impregnated graphite foils (purity >99.85 %) manufactured without adhesive with 0.05 mm thick stainless steel foils (AISI 316 L).

Original Sigraflex® HD, 9593/HIG: with inner eyelet made of stainless steel (1.4571), thickness: 0.15 mm.

### Advantages

Statotherm HDP is the perfect solution for applications with high flange pressures and high operating pressures. The gasket is used for applications with a high demand for operating safety and leak tightness; also in power plants as asbestos-free alternative for vessel seals.

- Good performance under temperature cycling, no aging, doesn't become brittle, because free of glue
- Very good handling
- High mechanical stability
- Stable long-term performance with respect to compression and resilience properties over a wide temperature range

### Operating range

Pressure:  $p = 250$  bar  
 Temperature:  $t = -200$  °C ...  $+450$  °C, steam:  $+550$  °C  
 Chemical resistance:  $pH = 0$  ...  $14$

### Forms of supply

- Sheet size: 1,000 x 1,000 mm; 1,500 x 1,500 mm
- Thickness: 1.0/1.5/2.0/3.0/4.0 mm
- According to drawing, measurements or other agreements

### Recommended applications

- Building services industry
- Power plant technology
- Resistant to almost all organic and inorganic acids, alkalis, oils and solvents
- Compressors
- Flange connections
- Pipe connections
- Valves

### Standards and approvals

- DVGW
- BAM approval (130 bar/100 °C)
- TA-Luft (>55 Mpa)
- TÜV
- Germanischer Lloyd
- Fire safe acc. to API 607/BS6755

### Notes

For a safe installation use dry and undamaged gaskets. Wet graphite gaskets should be installed after complete drying.

### Variants

- 9593/HDR (rings, gaskets)
- 9593/HDM (manhole gasket acc. to German TRD 401)
- 9593/HIG (with inner eyelet)
- 9593/HDP (impregnated for low leakage application acc. TA-Luft)

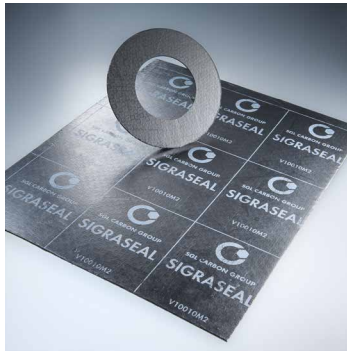

### Statotherm S6P 9593/S6P

#### Features

Gasket sheet made of flexible graphite, with stainless steel tanged metal reinforcement (316 L, 0.1 mm thickness), purity >98,0 %.

#### Advantages

Graphite sheet with tanged metal reinforcement. Applicable for steam, gases, oils, aggressive media in all branches of industry. Used in pipe flanges, handholes, pump flanges, valves, ball valves etc.

#### Operating range

Pressure:  $p = 100$  bar  
 Temperature:  $t = -200$  °C ...  $+500$  °C  
 steam:  $+550$  °C  
 Chemical resistance:  $pH = 0$  ...  $14$

#### Forms of supply

- Sheet size: 1,500 x 1,500 mm
- Thickness: 1.0/1.5/2.0/3.0 mm
- According to drawing, measurements or other agreements.

#### Recommended applications

- Process industry
- Petrochemical industry
- Chemical industry
- Power plant technology
- Pulp and paper industry
- Mining industry
- Building services industry
- Sugar industry
- Metal production and processing
- Resistant to almost all organic and inorganic acids, alkalis, oils and solvents
- Centrifugal pumps
- Covers
- Hatches
- Flange connections
- Pipe connections
- Ovens
- Maintenance seals

#### Standards and approvals

- DVGW

#### Variants

- 9593/S6R (rings)
- 9593/S6G (with eyelet)

Surface pressure diagram as a function of seal thickness ( $s$ ) to width ( $b_0$ )

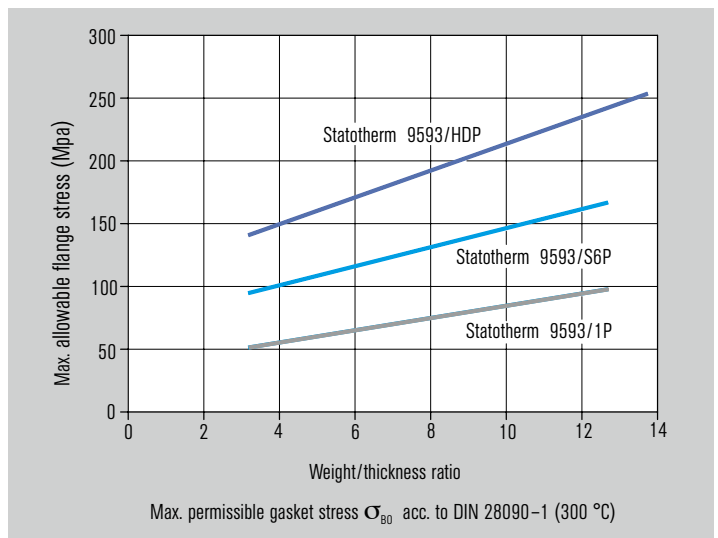
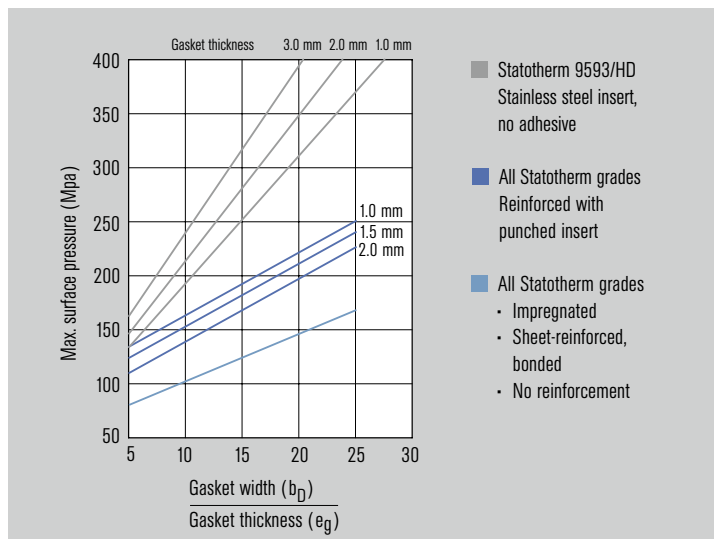

#### Sealing characteristics

Under maximum surface pressure of  $Q_{MAX}$ , Statotherm is compressed to approximately half of its initial thickness  $s$  and attains its highest cross-sectional density. For gaskets with inserts, the compression refers to the thickness of the graphite layer.

# Graphite seals and tapes



**Statotherm R profile rings R901/B...**

## Features

Profile rings made from permanently elastic, expanded graphite (>99.85 % graphite) without binders or fillers. Statotherm profile rings provide good deformability, permanent resilience, long-term flexibility and good structural strength.

## Advantages

Statotherm R profile rings provide:

- Good deformability
- Permanent resilience
- Long-term flexibility
- Good structural strength

Profile rings, that are almost maintenance-free, for severe temperature changes and/or extreme temperatures, which cannot be handled by elastomeric O-rings.

## Operating range

Pressure:  $p = 500$  bar  
 Sliding velocity (pump applications):  
 $vg = 2$  m/s  
 Temperature:  $t = -200$  °C ...  $+500$  °C,  
 steam:  $+550$  °C  
 Chemical resistance: pH = 0 ... 14 Ash  
 (<0.15 %)  
 Content: chloride content = <20 ppm;  
 Density (raw material): 0.7 or 1.0 g/cm<sup>3</sup>

## Forms of supply

- All sizes (min. diameter 3 mm) and profiles up to max. diameter  $\varnothing$  1,000 mm
- Die-pressed rings, closed or in segments

## Recommended applications

- Process industry
- Petrochemical industry
- Chemical industry
- Power plant technology
- Building services industry
- Resistant to almost all organic and inorganic acids, alkalis, oils and solvents
- Centrifugal pumps
- Piston pumps
- Compressors
- Valves
- Flange connections

## Notes

The deformation of Statotherm profile rings is permitted in axial direction only. The construction of the groove must be designed to avoid any radial deformation of the sealing ring as this may destroy it.

## Variants

R901/B5: density 1.3 g/cm<sup>3</sup>  
 R901/B6: density 1.4 g/cm<sup>3</sup>  
 R901/B7: density 1.6 g/cm<sup>3</sup>  
 R901/B8: density 1.8 g/cm<sup>3</sup>

## Pressure selection and surface pressure for non-load bearing configurations

Pressure (bar)	<160	<250	<400
Required deformation (%)	15	15	15
Required surface pressure (Mpa)	25	55	70
Density (g/cm <sup>3</sup> )	1.4	1.5	1.6

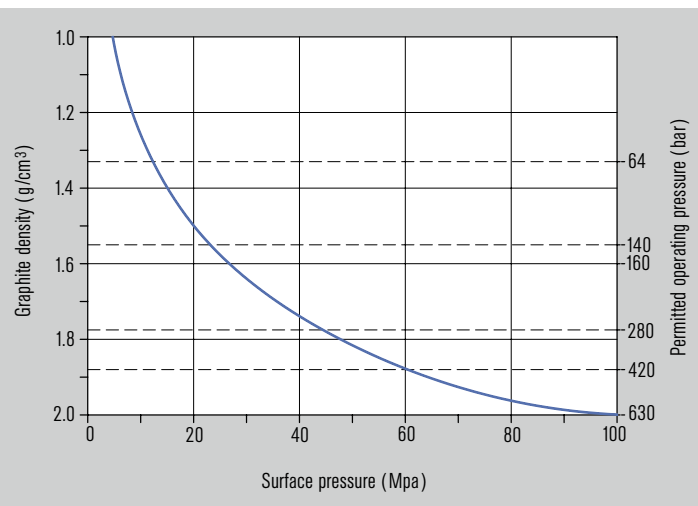

Sealing and pre-stressing are usually effected through application of the working pressure. A minimum working pressure is required, however.

## Recommended profile dimensions (max. outside diameter x cross-section)

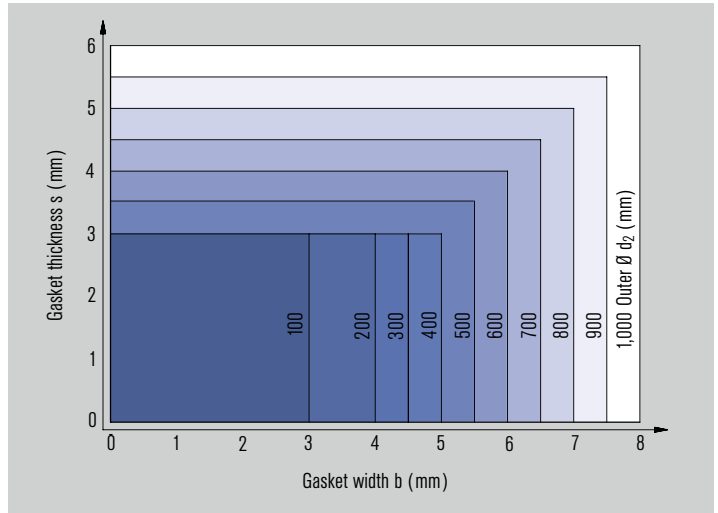

## Recommended groove tolerances

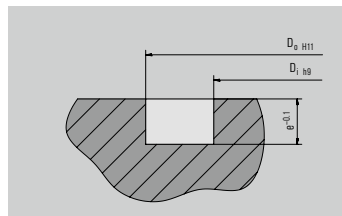

## Recommended ring tolerances

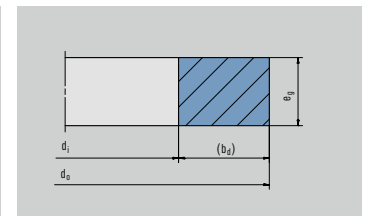

Tolerances for  $d_i$  and  $d_o$  are coordinated with the groove tolerances. Necessary for the groove surface finish:  $R_z = 10 \dots 40 \mu\text{m}$  (= ISO 1302)

## Standard profiles

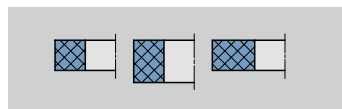

## Special profiles (examples)

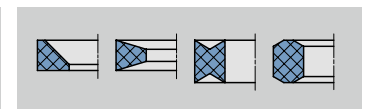

## Deformability and spring-back

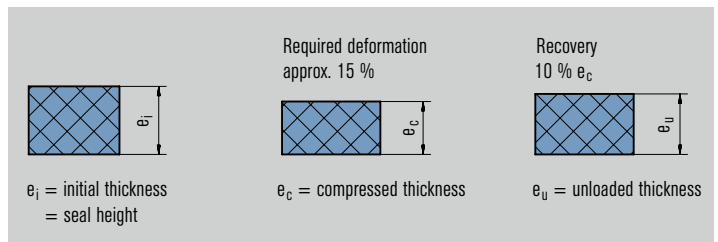





**Statotherm V cover seal V881-...**

**Features**

Statotherm V cover seals are made from pure graphite (99.8 %) with internal stainless steel inserts for seal spaces with larger gaps and/or higher pressures, e.g. for power plants at high temperatures and up to approximately 1,000 mm diameter.

**Advantages**

- Statotherm cover seals are applied as self-sealing gaskets in high-pressure valves
- They do not harden, have a long service life and can easily be installed and removed without damaging the seal surfaces, as can happen with metallic seals
- The internal metal reinforcement allows the seal to bridge larger gaps, minimizing extrusion and ensuring operating safety

**Operating range**

Pressure:  $p = 800$  bar  
 Sliding velocity:  $vg = 2$  m/s  
 Temperature:  $t = -200$  °C ...  $+500$  °C, in reducing or inert atmosphere:  
 $+3,000$  °C  
 Chemical resistance:  $pH = 0$  ...  $14$

V881-B6: density  $1.4$  g/cm<sup>3</sup>  
 V881-B7: density  $1.6$  g/cm<sup>3</sup>  
 V881-B8: density  $1.8$  g/cm<sup>3</sup>

**Forms of supply**

- Die-pressed rings, according to drawing, measurements or other agreements
- In different densities and profiles

**Recommended applications**

- Process industry
- Petrochemical industry
- Chemical industry
- Power plant technology
- Building services industry
- Resistant to almost all organic and inorganic acids, alkalis, oils and solvents
- Valves

**Variants** (profiles see right)

V881-R7 (rectangular)  
 V881-A7 (outer chamfer)  
 V881-I7 (inner chamfer)  
 V881-R7K (rectangular with one cap)  
 V881-A7K (outer chamfer with one cap)  
 V881-I7K (inner chamfer with one cap)  
 V881-K7 (cap for oxidation protection,  $t \leq 650$  °C)



**Statotherm V cover seal V901/...**

**Features**

Statotherm V901 rings are high-precision seals, which give a very good sealing result with excellent service life combined with very little wear. They are made from permanently elastic, expanded graphite (>99 % graphite, nuclear grade) without binders or fillers.

**Advantages**

- Statotherm V901 cover seals are used as self-sealing gaskets in high-pressure valves, e.g. for power plants at high temperatures and up to approx. 1,000 mm diameter
- They do not harden, have a long service life and can easily be installed and removed without damaging the seal surface, as can happen with metallic seals

**Operating range**

Pressure:  $p = 500$  bar  
 Sliding velocity:  $vg = 2$  m/s  
 Temperature:  $t = -200$  °C ...  $+500$  °C  
 Temperature limit for steam:  $+550$  °C  
 Chemical resistance:  $pH = 0$  ...  $14$

O901/B5: density  $1.3$  g/cm<sup>3</sup>  
 O901/B6: density  $1.4$  g/cm<sup>3</sup>  
 O901/B7: density  $1.6$  g/cm<sup>3</sup>  
 O901/B8: density  $1.8$  g/cm<sup>3</sup>

**Forms of supply**

- Die-pressed rings, acc. to drawing, measurements or other agreements
- Profile I = ring with inner bevel, profile A = ring with outer bevel, profile R = rectangular diameter
- "N" at the end of Art. No. stands for "Nuclear quality", e.g. V901/7N

**Variants** (profiles see right)

Rectangular profile (without, with one or two end caps):  
 V901/R7, V901R7K, V901RKK, V901RWK  
 Outer chamfer (without, with one or with two caps):  
 V901/A7, V901A7K, V901AKK  
 Inner chamfer (without, with one or with two caps):  
 V901/I7, V901I7K, V901I

**Recommended applications**

- Process industry
- Petrochemical industry
- Chemical industry
- Power plant technology
- Building services industry
- Valves

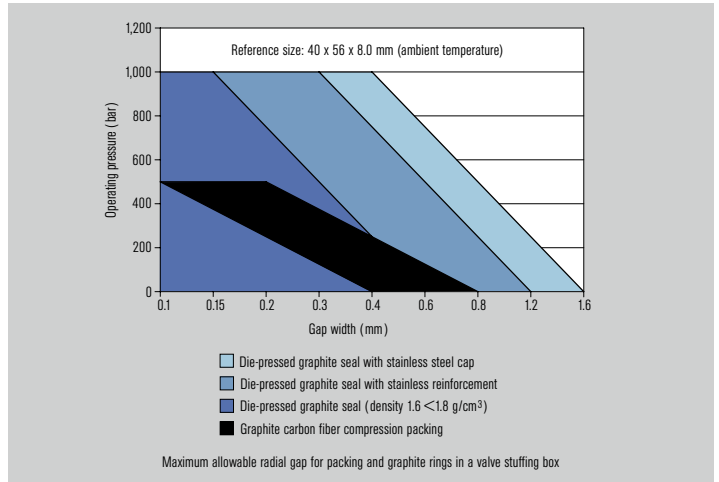

**Sealing characteristics (N/mm<sup>2</sup>)**

Sealing and pre-stressing are usually effected through application of the working pressure. A minimum working pressure is required, however.

V901/R7 :  $\sigma_{vu} = 10$   
 V901/I7 :  $\sigma_{vu} = 8$   
 V881/R7 :  $\sigma_{vu} = 12$   
 V881/I7 :  $\sigma_{vu} = 10$   
 $\sigma_{vu}$  = dependent on gap size  $m = 1.4$

**Dimensions and tolerances**

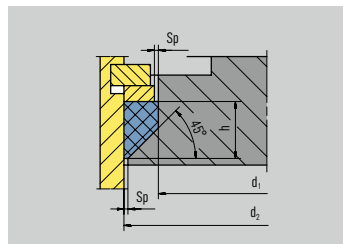

Profile I with inner bevel – tolerances for valve connection parts:  $d_1 = h_9$ ,  $d_2 = h_{11}$

**Design and ordering instructions**

Design of the cover gasket is conditional on the pressure and dimensions. For enquiries or orders, please state operating conditions and profile form (for example: pressure in bar, diameters  $d_1$  and  $d_2$ ; profile form I, A, R).

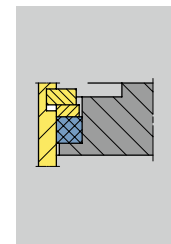

Profile R – rectangular

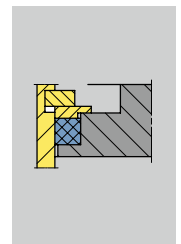

Cover type with fixed metal stop. Recommended for sealing pressure  $P_D > 150$  N/mm<sup>2</sup>.

**V881 profiles**

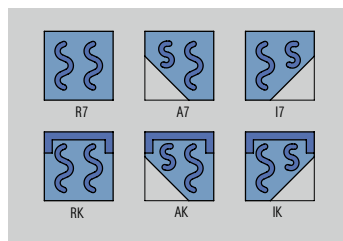

**V901...V911 profiles**

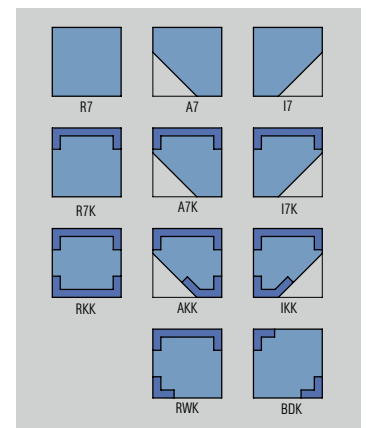

# Graphite maintenance seals



**Manhole gasket – HP 6365/HP**

## Features

Classic seal made of rubber with woven mesh. This material is especially designed to meet the high requirements of TRD 401 material test class D, temperature-, corrosion- and chemical-resistant high-duty mesh with elastomer coating.

## Advantages

The classic mesh-rubber seal is based on a new mesh design with high density and excellent media resistance EagleBurgmann Manhole gasket HP:

- Has a very safety-oriented design of seal surface
- Adapts to optimum seal profile with existing cover lids, independent of existing sealing system
- Easy installation and removal

## Operating range

Pressure:  $p = 40$  bar  
 Temperature:  $t = +250$  °C  
 Surface pressure: min.  $5$  N/mm<sup>2</sup>,  
 max.  $35$  N/mm<sup>2</sup>  
 Recommended warm-up gradient:  
 max.  $2$  °C/min.

## Forms of supply

Standard dimensions:  
 80 x 120 x 15 x 8 mm  
 100 x 150 x 15 x 8 mm  
 115 x 165 x 15 x 8 mm  
 150 x 200 x 15 x 8 mm  
 220 x 320 x 25 x 10 mm  
 300 x 400 x 25 x 10 mm  
 320 x 420 x 25 x 10 mm  
 350 x 420 x 25 x 10 mm  
 (other dimensions on request)

## Recommended applications

- Power plant technology
- Building services industry
- Boiler feed water/media resistance acc. to TRD 611
- Covers
- Hatches

## Standards and approvals

TRD material test class D

## Notes

The seal should be re-tightened after restarting the boiler and will reach a safe operating condition after finishing this action.



**Statotherm V-Flex 6850/V**

## Features

Cover seal packing braided with a rectangular profile. Made of permanently elastic pure graphite foils (96 % graphite) with Inconel® wire reinforcement to increase pressure resistance. Doesn't contain binders.

## Advantages

- Cover seal by the meter
- For general on-site maintenance use as self-sealing cover seal in high-pressure valves, e.g. for power plants at high temperatures and independent of diameter
- Very flexible, non-hardening, long service life, easy installation without risk of damaging the sealing surfaces as can happen with metallic seals

## Operating range

Pressure:  $p = 500$  bar  
 Temperature:  $t = -200$  °C ...  $+500$  °C  
 Temperature limit for steam:  $+550$  °C  
 Chemical resistance:  $\text{pH} = 0$  ...  $14$   
 Chloride content:  $\leq 100$  ppm  
 Average density:  $1.4$  g/cm<sup>3</sup>

## Forms of supply

Supplied by the meter, on rolls  
 5 x 12 mm  
 7.5 x 15 mm  
 10 x 15 mm  
 15 x 30 mm  
 20 x 30 mm  
 25 x 35 mm  
 27.5 x 50 mm  
 30 x 45 mm

## Recommended applications

- Oil and gas industry
- Petrochemical industry
- Power plant technology
- Building services industry
- Covers
- Hatches
- Valves
- Maintenance seals

## Notes

Not suitable for strong oxidizing media. Preferably to seal in places, where inner bevel, outer bevel or rectangular profiles are needed. This seal will adapt to any of those.

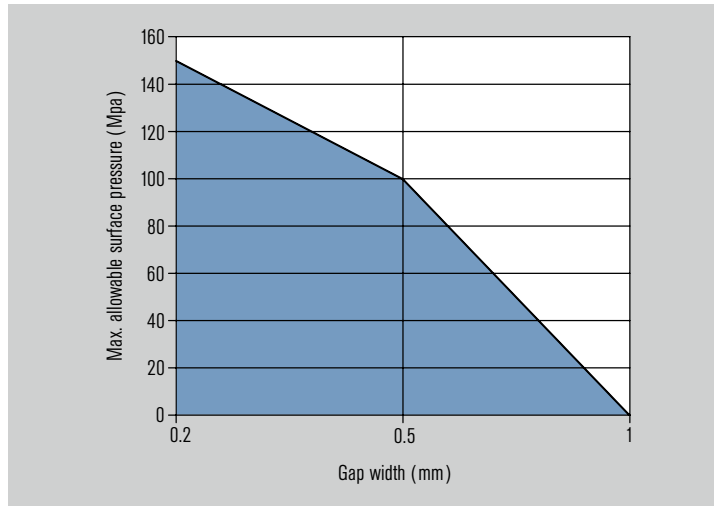

## Statotherm V-Flex 6850/V:

Surface pressure in dependence on gap width during operation

- $\sigma_{vu}$  =  $20$  N/mm<sup>2</sup>
- $\sigma_{vo}$  = depends on the gap size (refer to graph)
- $m$  =  $1.4$
- $\sigma_{vu}$  = min. installed surface pressure in N/mm<sup>2</sup>
- $\sigma_{vo}$  = max. installed surface pressure in N/mm<sup>2</sup>
- $m$  = seal factor for test and operating modes

# Mica gasket sheets



## Statotherm tape 6750

### Features

Statotherm Gasket tape is a braided graphite tape with reinforced Inconel® wire and adhesive backing. Made from pure graphite fibers, the tape has good chemical resistance and temperature stability.

### Advantages

- Statotherm Gasket tape can be used as a nearly endless sealing tape to seal all flange forms and styles
- The combination of selected graphite material and the production process results in a non-aging, easy-to-handle sealing tape which shows a high recovery ratio

### Operating range

Pressure:  $p = 250$  bar (if constrained)  
 25 bar (6750/INC) on flat-face or R/F flanges  
 16 bar (6750) on flat-face or R/F flanges  
 Temperature:  $t = -200$  °C ...  $+550$  °C  
 Chemical resistance: pH = 0 ... 14

### Forms of supply

2 kg/roll

Standard dimensions:  
 12.7 x 3.2 mm  
 25.4 x 6.4 mm  
 31.8 x 6.4 mm  
 38 x 6.4 mm

### Recommended applications

- Process industry
- Petrochemical industry
- Chemical industry
- Power plant technology
- Water and waste water technology
- Mining industry
- Building services industry
- Shipbuilding
- Metal production and processing
- Flange connections
- Pipe connections
- Exhaust ducting
- Ovens
- Furnaces

### Notes

The tape could be used in flat-face or raised-face flange connections at pressures up to 25 bar. For high-pressure applications the tape should be installed in a retaining groove. The packing can be stored in its original packaging for a minimum of 3 years in dry, cool conditions. The maximum stated operating temperature and pressure cannot be used simultaneously.

### Variant

6750/INC (braided graphite tape with reinforced Inconel® wire and adhesive backing)

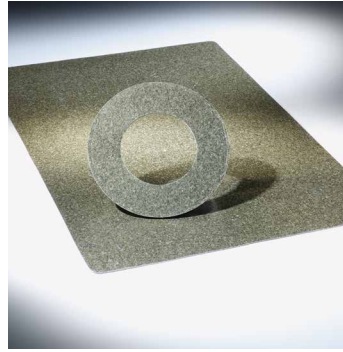

## Statotherm HT 9560

### Features

Statotherm HT has the excellent characteristic of growing (in thickness) at the same rate as the flange material expansion rate, i.e. the sealing material follows the deformation of the flange while retaining the necessary tightness with exceptional stability.

### Advantages

The properties of Statotherm HT make it ideal for sealing burner flanges in combustion systems, high-temperature heat exchangers, gas turbine housings, flange joints of turbochargers and other exhaust gas superchargers, industrial ceramic components, aerospace, motor vehicle engines – for fitting between the cylinder head and manifold and in the downstream flange joints of controlled catalytic convection systems.

### Operating range

Pressure:  $p = 5$  bar  
 Temperature:  $t = +950$  °C in oxidizing atmosphere,  $>1,100$  °C in non-oxidizing conditions

### Materials

Sealing material: mica compound  
 Reinforcement: tanged sheet 1.4828 or 1.4401  
 Eyeletting: 1.4828

### Forms of supply

Sheet size: 1,000 x 1,016 mm in 0.4 mm thickness  
 Sheet size: 1,500 x 1,000 mm in 0.7 mm and 1 mm thickness

### Recommended applications

- Aerospace industry
- Power plant technology
- Metal production and processing
- Gaseous media, including those containing solids
- Blowers
- Flange connections
- Exhaust ducting
- Ovens
- Furnaces
- Pressure:  $p = 5$  bar
- Temperature:  $t = +950$  °C in oxidizing atmosphere,  $>1,100$  °C in non-oxidizing conditions

### Variants

9560/2 with tanged metal reinforcement (1.4828)  
 9560/2G with tanged metal reinforcement and eyeletting (1.4828/1.4828)  
 9560/3 with tanged metal reinforcement (1.4401)

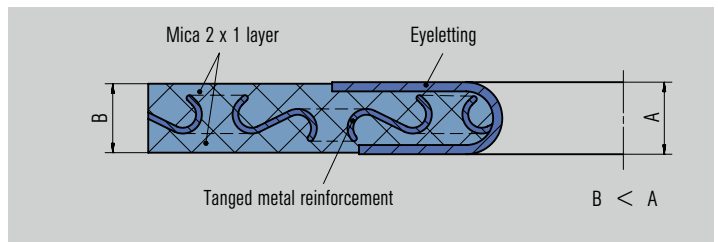

Standard design with punched sheet reinforcement and high-temperature resistant steel eyeletting

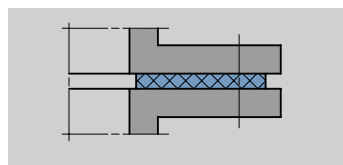

Prior to initial start-up

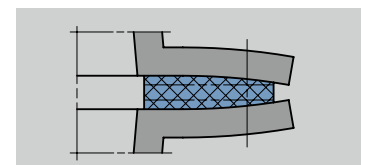

After flange warping due to heat

### Variants

Product No.	Description	Reinforcement / eyeletting	Seal thickness (mm)
9560/P	Statotherm HT sheet, un-reinforced		0.4 (Sheet size: 1,000 x 1,016 mm)/0.7 and 1.0 (Sheet size: 1,500 x 1,000 mm)
9560/2	Statotherm HT (cut gasket only), tanged metal reinforcement	1.4828	1.3/1.7
9560/3	Statotherm HT sheet, tanged metal reinforcement	1.4401	1.3/1.7/2.0 (Sheet size: 1,200 x 1,000 mm)

Other reinforcement materials available on request

# Spiral wound gaskets



**Spiraltherm graphite S 9584**

## Features

Spiraltherm gaskets are manufactured in several combinations of materials with a wide range of dimensions and geometry. They are widely used in refineries, the chemical and petrochemical industry as well as in the power generation industry.

## Advantages

- Spiraltherm spiral wound gaskets have exceptionally high operating reliability for high-pressure applications including load bearing and non-load bearing installations
- Seal under severe operating conditions
- Excellent load distribution, stable and reliable sealing performance even under frequent pressure cycles
- Solid construction provides stability and sealability even under severe conditions
- Great resilience (approx. 10 % of uncompressed height)
- Easy installation

## Operating range

Pressure:  $p = \dots 400$  bar (class 2,500 lbs) for flanges according to EN or ASME standard  
 Temperature:  $t = -200$  °C ...  $+550$  °C (higher temperature possible in an inert atmosphere)  
 Chemical resistance: pH = 0 ... 14

## Materials

Metal winding  
 Stainless steels – most common are: AISI 316L, 316, 304, 304L, 321 (1.4541), 316 Ti (1.4571), 347, ...  
 Special alloy windings are also available, e.g. Monel®, Incoloy®, Hastelloy®, Titanium, ...  
 Filler materials  
 In order to prevent oxidation at elevated temperatures, a high-quality graphite with oxidation inhibitor can be offered.

## Standards and approvals

TA-Luft for 9584/GIA  
 Germanischer Lloyd 44510 HH  
 BAM certification

## Recommended applications

- Process industry
- Oil and gas industry
- Petrochemical industry
- Pharmaceutical industry
- Power plant technology
- Pulp and paper industry
- Water and waste water technology
- Mining industry

- Building services industry
- Food and beverage industry
- Shipbuilding
- Sugar industry
- Metal production and processing
- Centrifugal pumps
- Piston pumps
- Compressors
- Valves
- Heat exchangers
- Covers
- Hatches
- Reactor vessels
- Process vessels
- Flange connections
- Pipe connections
- Maintenance seals

## Notes

Spiraltherm gaskets filled with graphite are fire safe.

Parameter		Spiraltherm graphite S 9584	Spiraltherm graphite H 9594	Spiraltherm PTFE 9595	Spiraltherm Mica 9596
Design	Filler material	98 % pure graphite	99.85 % pure graphite	Virgin PTFE	Mica
	Metal winding	Standard grades: 1.4541 (AISI 321) 1.4571 (AISI 316 Ti) Other materials on request	Standard grades: 1.4541 (AISI 321) 1.4571 (AISI 316 Ti) Other materials on request	Standard grades: 1.4541 (AISI 321) 1.4571 (AISI 316 Ti) Other materials on request	Standard grades: 1.4541 (AISI 321) 1.4571 (AISI 316 Ti) Other materials on request
	Inner ring	Corresponds to material of metal winding	Corresponds to material of metal winding	Corresponds to material of metal winding	Corresponds to material of metal winding
	Outer ring	Galvanized or epoxy-coated carbon steel	Galvanized or epoxy-coated carbon steel	Galvanized or epoxy-coated carbon steel	Galvanized or epoxy-coated carbon steel
Variants	.../NF	For tongue and groove flanges	For tongue and groove flanges	For tongue and groove flanges	For tongue and groove flanges
	.../VR	For recessed flanges	For recessed flanges	For recessed flanges	For recessed flanges
	.../VRI	For recessed flanges with inner ring	For recessed flanges with inner ring	For recessed flanges with inner ring	For recessed flanges with inner ring
	.../GIA	For raised-face flanges with inner and outer rings	For raised-face flanges with inner and outer rings	For raised-face flanges with inner and outer rings	For raised-face flanges with inner and outer rings
	.../GA	For raised-face flanges with outer ring	For raised-face flanges with outer ring	For raised-face flanges with outer ring	For raised-face flanges with outer ring
	.../MH	Manhole sealing ring	High-purity design, metal winding of 1.4541 or 1.4571. Filler material is 99.85 % nuclear grade pure graphite		
	.../NFS		Deformation characteristics (compression curve) available on request High-purity design, metal winding of 1.4541 or 1.4571. Filler material is 99.85 % nuclear grade pure graphite		
Operating pressure	Up to 400 bar (class 2,500) for flanges according to DIN or ASME. Higher pressures available on request. Helium leak tightness: $1.7 \times 10^{-9}$ mbar*/l/s	Up to 400 bar (class 2,500) for flanges according to DIN or ASME. Higher pressures available on request. Helium leak tightness: $1.7 \times 10^{-9}$ mbar*/l/s	Up to 400 bar (class 2,500) for flanges according to DIN or ASME. Higher pressures available on request. Helium leak tightness: $1.7 \times 10^{-9}$ mbar*/l/s	< 10 bar	
Temperature °C	-200 °C ... +550 °C (higher temperatures are possible in an inert atmosphere depending on steel grade – please enquire)	-200 °C ... +550 °C (higher temperatures are possible in an inert atmosphere depending on steel grade – please enquire)	-200 °C ... +280 °C	+600 °C ... +900 °C	
pH range	0 ... 14	0 ... 14	0 ... 14		
Application	In high-pressure pipe systems for all flanges and flange-type joints in chemical and petrochemical installations. On-board ship and in power stations for low and high-pressure steam systems	In high-pressure pipe systems for all flanges and flange-type joints in chemical and petrochemical installations. In nuclear power installations for valves and fittings, pressure boilers, pumps (KWU tested) and cooling circuits (helium and carbon dioxide)	In high-pressure pipe systems for all flanges and flange-type joints in chemical and food industry		
Approvals & certification	BAM certification for /NR, /VRI, /GIA in oxygen up to 350 °C and 250 bar TA-Luft certification for #9584/GIA ( $3.5 \times 10^{-6}$ mbar*/l(sm) Fire safe acc. to API 6FA	TA-Luft certification for #9584/GIA Germanischer Lloyd 44510 HH			
Supply	Form	All sizes available for standard flange connections to DIN, ANSI, BS, JIS. Special dimensions available on request.			

Spiral wound gasket profile with outer and inner ring, windings and filler

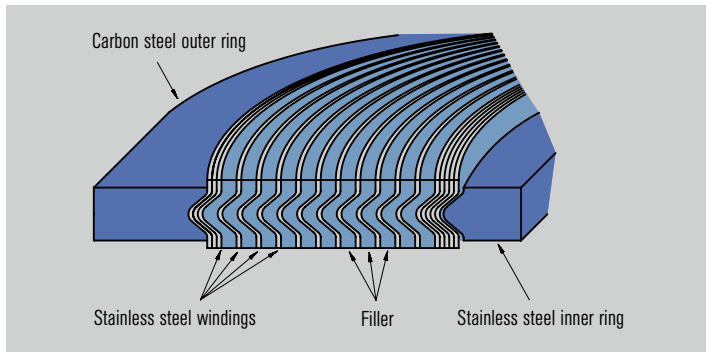

Spiral wound gaskets can be manufactured in special designs:

- Stadium
- Oval
- Three-center curve

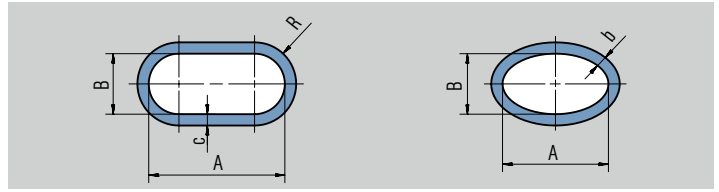

Product variants

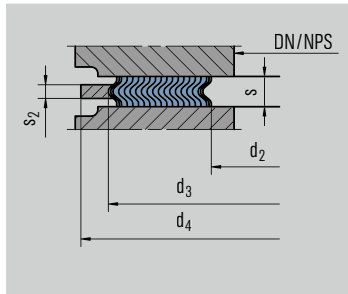

**Spiraltherm .../GA**  
Spiral wound gasket with outer guide ring. Standard type for raised-face flange connections.

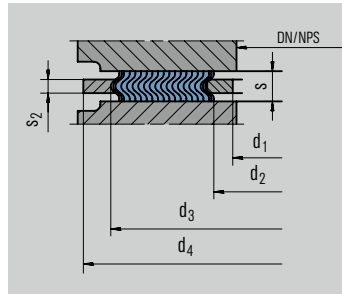

**Spiraltherm .../GIA**  
Spiral wound gasket with inner and outer guide ring. This style offers the best performance for raised-face flange connections. The inner ring is used to provide:

- Avoidance of over-compression at elevated seating loads in high-pressure service
- Reduced turbulence within the flange area and protection against corrosion or erosion
- Improvement of the load distribution over the gasket

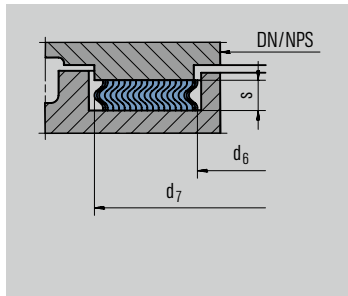

**Spiraltherm .../NF**  
Spiral wound gasket without guide or inner ring. This style of gasket is used in load-bearing flange configurations, such as tongue and groove flanges. Standard dimensions according to EN/ASME.

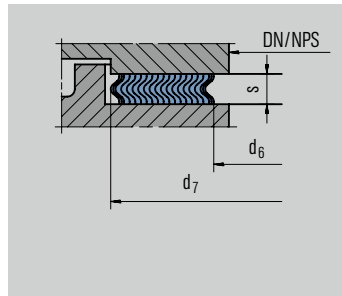

**Spiraltherm .../VR**  
Spiral wound gasket without inner ring or outer guide ring. Mainly used for male and female flanges or projection and recess flanges.

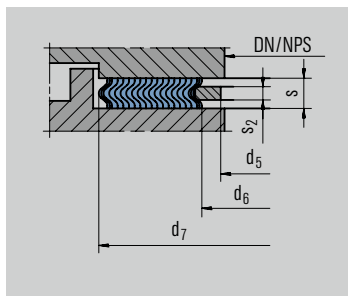

**Spiraltherm .../VRI**  
Spiral wound gasket with inner ring. Mainly used for male and female flanges or projection and recess flanges. An inner ring is necessary as a compression stop.

# Spiral wound gaskets

## Spiraltherm spiral wound gasket 9584.

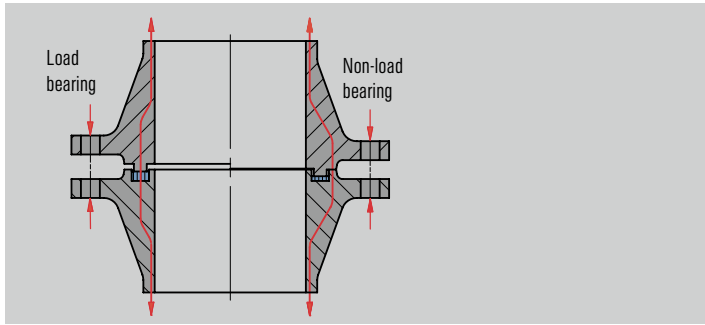

Design of connections for tongue and groove flanges

### Design of connections with load bearing gaskets

For Spiraltherm .../NF or /VR, /VRI, /GIA, /GA.

Standard dimensions of gaskets for use in load-bearing configurations are given in the tables shown on page 44 – 46. For designs which deviate from standard the following dimensions are recommended (sizes in mm).

## Load bearing gaskets

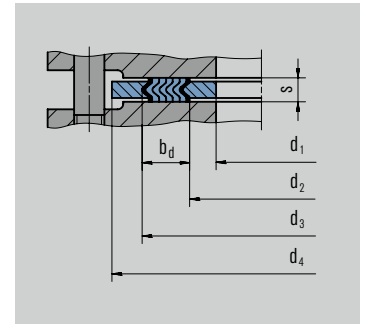
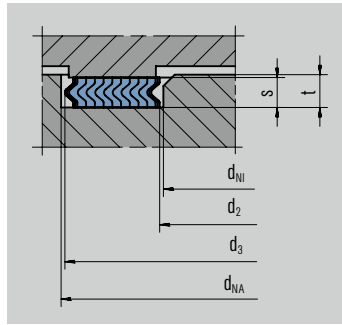

DN	$d_2$	$d_3$	S
≤ 600	$d_{NI}^{+0.5}$	$d_{NA}^{-0.5}$	$3.5^{+0.2 / +0.8}$
≤ 1,000	$d_{NI}^{+1.0}$	$d_{NA}^{-1.0}$	$4.5^{+0.2 / +0.8}$

DIN 2505 Part 2	$\sigma_{HI}$ 65	$\sigma_{HO}$ 300	m 1.4
AD-Guidelines B7	$k_0 \times k_D$ 65 x $b_d$		$k_1$ $1.4 \times b_d$
ASME Code	m 2.5	y (PSI) 10,000	y (Mpa) 70

## Design of connections with non-load bearing gaskets

For Spiraltherm .../NF gaskets in a non-load bearing arrangement no further compression of the gasket is possible when the flanges are in contact. Extremely accurate sizing of the groove and gasket is therefore necessary. Since no standards exist as yet for the use of spiral wound gaskets in non-load bearing applications, we suggest applying the recommendations in the adjacent table. To achieve an optimum sealing action, the ratio of gasket volume to groove volume must be favorable. This is achieved by applying the formula:

$$\frac{b_D}{b_N} \approx 0.86$$

When  $b_D < 6.5 = 0.85$

We can supply you with calculations (seal dimensions, bolt force, etc.) and compression test data if required.

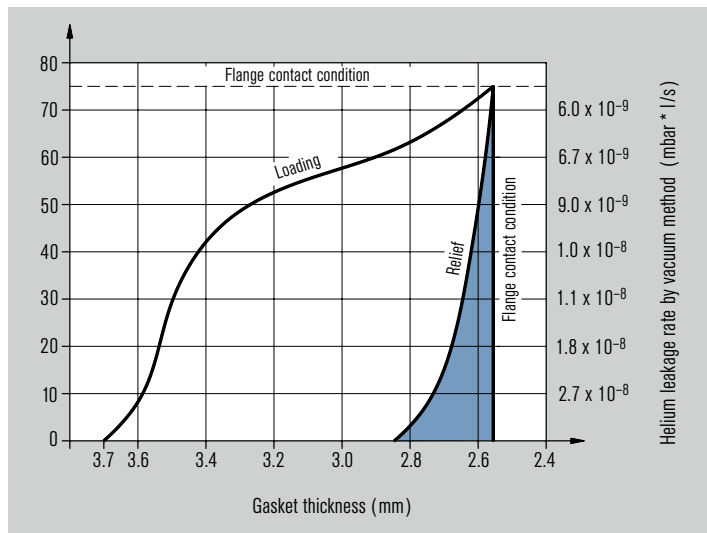
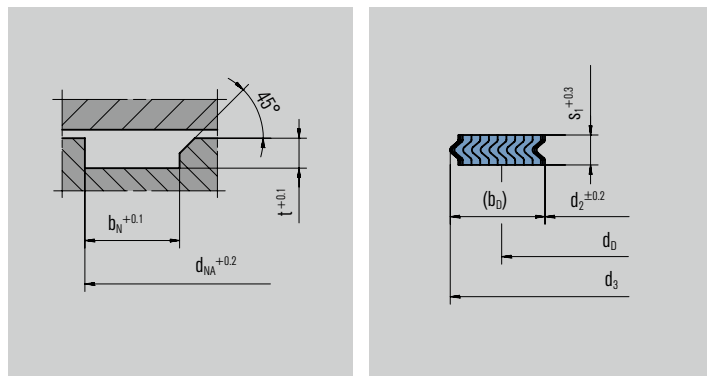
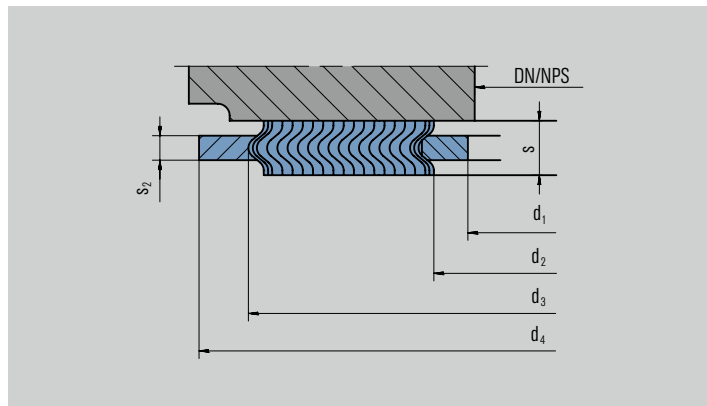

## Manufacturing tolerances for fillers and windings (mm)

Tolerances	ASME B16.20*	EN 1514*	EagleBurgmann internal standard
s (tolerance including the filler)	+0.07 +0.063	+0.4 +1.1	+0.2 +0.8
s <sub>1</sub> (tolerance for the metal winding only)	+0.13	+0.3	+0.3
Filler overlap tolerance total (incl. both sides)	Smooth overlap	+0.4 +0.8	+0.2 +0.5
s <sub>2</sub> (tolerance for the guide and inner ring thickness)	+0.33 -0.03	±0.25	+0.25 -0.05
Tolerances for gasket diameters	See ASME Standard	See EagleBurgmann internal standard	See EagleBurgmann internal standard

\* Only for load bearing applications.

Spiraltherm gaskets	Groove						
d <sub>3</sub>	b <sub>D</sub>	d <sub>2</sub>	S <sub>1</sub> <sup>+0.3</sup>	d <sub>NA</sub>	b <sub>N</sub>	d <sub>NI</sub>	t <sub>N</sub>
<300	≤7		3.5	d <sub>3</sub> + 0.5	b <sub>D</sub> /0.86	d <sub>NA</sub> - 2 <sub>DN</sub>	2.5 <sup>+0.1</sup>
<1,000	≤7		3.5	d <sub>3</sub> + 1.0		d <sub>NA</sub> - 2 <sub>DN</sub>	2.5 <sup>+0.1</sup>
<300	≤7	d <sub>3</sub> - 2 x b <sub>D</sub>	4.5	d <sub>3</sub> + 0.5		d <sub>NA</sub> - 2 <sub>DN</sub>	3.3 <sup>+0.1</sup>
<1,000	≤7		4.5	d <sub>3</sub> + 1.0		d <sub>NA</sub> - 2 <sub>DN</sub>	3.3 <sup>+0.1</sup>
<1,000	≤7	d <sub>3</sub> - b <sub>D</sub>	6.5	d <sub>3</sub> + 1.0		d <sub>NA</sub> - 2 <sub>DN</sub>	4.7 <sup>+0.1</sup>

$\sigma_{vu} = 65$   $\sigma_{v0} = 500$   $m = 1.4$   $Rz = 12.5 \dots 30 \mu m$

Spring characteristic and helium tightness of Spiraltherm (47 x 55 x 3.7 mm) in a non-load bearing configuration. Diagram shows Helium leakage rate and gasket spring-back in flange contact condition (75 N/mm<sup>2</sup>) during subsequent load relief.

### Installation Note:

If the flange has no projection or retaining recess for the gasket, it will need an outer back-up and centering ring. A very exact design calculation and measurement of seal as well as of groove is necessary. This is because for Spiraltherm in non-load bearing connections, no further compression of the gasket is possible when the flanges are in contact.

# Corrugated gaskets



**Corratherm corrugated gasket 2897**

## Features

High-quality two-component gasket: core made of corrugated stainless steel profile ring with flexible Statotherm graphite foil on both sides.

The gasket construction for an outside diameter up to 1,000 mm is made in one piece, larger dimensions have a welded profile ring.

## Advantages

Two-component corrugated gasket providing:

- Very low fugitive emissions performance
- High gas tightness
- Good pressure resistance, compressibility and excellent resilience even at a permanent operating temperature of 400 °C
- Good chemical resistance
- High blow-out safety with inner eyelet
- No sticking to flange
- Does not age or become brittle
- Easy handling, not harmful to health

## Operating range

Pressure:  $p = 50$  bar

Temperature:

$t = -200$  °C ...  $+450$  °C (graphite 98 %)

$t = -200$  °C ...  $+500$  °C (graphite 99.85 %)

$t = -200$  °C ...  $+250$  °C (PTFE)

Chemical resistance: pH = 0 ... 14

## Forms of supply

Preferred standards acc. to DIN EN 1514 as well as ASME standards

## Materials

Corrugated metal according AISI/ASTM 321 (1.4550) or 316Ti (1.4571)

## Recommended applications

- Process industry
- Oil and gas industry
- Petrochemical industry
- Chemical industry
- Power plant technology
- Building services industry
- Shipbuilding
- Heat exchangers
- Covers
- Hatches
- Reactor vessels
- Process vessels
- Flange connections
- Pipe connections

## Standards and approvals

TA-Luft (VDI 2440) approval  
Yarmouth Research: fire safe according to API standard 607/BS6755  
Approval according to ASME PVRC

## Notes

The marked outer rim carries information of the size, material and pressure class of the gasket and gives an additional mechanical support when load is applied.

## Variants

2897/G with inner eyelet

2897/T PTFE-jacketed

2897/TG with inner eyelet

## Examples of heat exchanger gasket locations

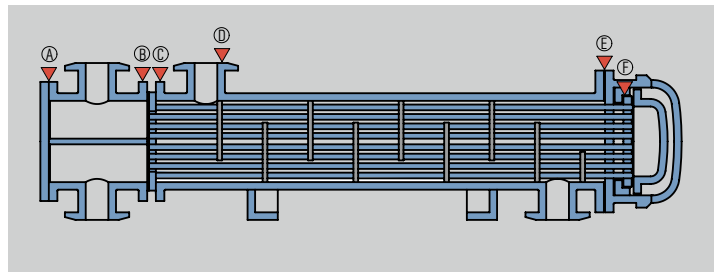

A Channel box cover

B Tube sheet/channel cover

C Shell/tube sheet

D Flanges

E Shell cover

F Floating head



**Corratherm 2897**



**Corrachem 2897/T**



# Kammprofile gaskets



**Kammprofile serrated gasket 9598**

## Features

The Kammprofile serrated gasket has a concentrically machined serrated profile from a 4 mm thick base plate and a layer of pure graphite (purity 99.85 %) on both sides, each with 0.5 mm thickness (thicker layers on request). The gasket is easy to handle and particularly appropriate for flanges and flange-like connections in chemical and petrochemical industry, in power plants and nuclear power plants, etc.

## Advantages

- The Kammprofile serrated gasket is designed for very sophisticated applications in load bearing connections with high demands on operating safety and tightness
- The gasket provides chemical resistance and an outstanding performance in cases of severe temperature cycling
- It is suitable for both high temperature and cryogenic applications

## Operating range

Pressure:  $p = 400 \text{ bar}$ ,  
 $>400 \text{ bar}$  on request  
 Temperature:  $t = -200 \text{ °C} \dots +550 \text{ °C}$   
 Chemical resistance:  $\text{pH} = 0 \dots 14$

## Forms of supply

The gaskets as supplied measures  $4+1 = 5 \text{ mm}$  thick. With optimum compression in installed condition the graphite layer above each crest measures approximately 0.15 mm, ensuring optimum sealing performance while preventing damage to the flange faces. The facing is normally applied using a low chloride adhesive.

## Materials

Serrated ring: Standard 1.4541, 1.4571;  
 Seal facing: Statotherm pure graphite  
 (Art. No. 9591/P)

## Recommended applications

- Process industry
- Oil and gas industry
- Petrochemical industry
- Chemical industry
- Power plant technology
- Building services industry
- Covers
- Hatches
- Process vessels
- Flange connections
- Heat exchangers
- Pipe connections
- Ovens
- Maintenance seals

## Standards and approvals

- TA-Luft
- DIN EN 1514-6
- Factory standards

## Notes

Recommended surface roughness  $R_z > 25 \mu\text{m}$ . For greater roughness up to max.  $50 \mu\text{m}$  the thickness of pure graphite layer should be increased. After first warm-up, retightening of bolts is recommended (only without system pressure). This will insure optimum surface pressure.

## Recycling:

The surface layer material can only be used once. The serrated gasket can be reused several times if not damaged.

## Variants

- 9598/P (with graphite filler, without centering ring – Form NR)
- 9598/PZ (with graphite filler, with centering ring – Form IR or LR)
- 9598/PB (with graphite filler, convex form)

## Sealing parameters (N/mm<sup>2</sup>)

$$\sigma_{v0} = 14; \alpha_{v0} = 500; m = 1.1$$

Kammprofile serrated gasket 9598 – installation details (referring to tables on page 43)

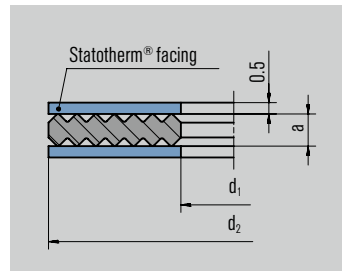

Item as delivered

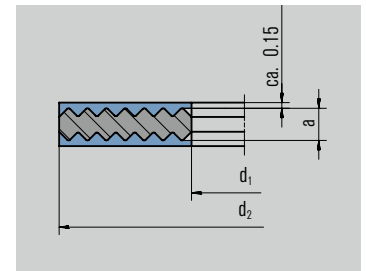

Item after installation

# Jacketed gaskets



## Buralloy jacketed gasket 2500

### Features

Buralloy metal-jacketed gaskets are produced in a wide variety of different materials (in various combinations), in many cross-sections and in many styles. They are suitable for flanges in heat exchangers, pipe flanges, boilers and process equipment.

### Design

Metal-jacketed gaskets, as the name suggests, consist of:

- Metallic outer shell with either a metallic or non-metallic asbestos-free filler
- The filler material gives the gasket resilience
- The metal jacket protects the filler and resists pressures, temperatures and corrosion

### Materials of construction

Inner gasket materials:

- Non-asbestos fiber sheet
- NBR/aramid fiber sheet
- Graphite

Metal jacket materials:

- Soft Aluminium
- Soft Copper
- Brass
- Carbon steel
- 304 or 304L stainless steel
- 316 or 316L stainless steel
- 321 stainless steel
- Hastelloy® B2 or C-276
- Inconel® 600
- Monel® 400

Other metals and alloys available on request.

### Technical data

Pressure and temperature parameters in accordance with customer specifications. Corrosion resistance is dependent upon the choice of materials. Please ask for advice if you are uncertain of the correct selection.

### Variants

Profile	Variant number	Application
	2500/BHX200 Flat metal	Suitable for valve bonnets, heat exchangers, tongue and groove joints. Requires relatively high bolt loads.
	2521/BHX210 Flat metal – graphite-covered	Suitable for valve bonnets, heat exchangers. Graphite facing provides excellent adaptability.
	2522/BHX220 French style – single-jacketed	Used in air tools, engines and where space is limited. Narrow width of gasket face < 5 mm.
	2523/BHX230 French style – double-jacketed	Simple gasket as BHX220. For wider gasket face width s > 5 mm.
	2524/BHX240 Single-jacketed – open style	Simple gasket as BHX220. For wider gasket face width s > 5 mm.
	2525/BHX250 Single-jacketed – totally enclosed	Used when filler material must be totally protected.
	2526/BHX260 Double-jacketed – totally enclosed	Most commonly used form of jacketed gasket. Can be made to almost any size and for most applications. Can be applied in standard flanges when the required compression is higher than is allowable for cut fiber gaskets.
	2527/BHX270 Double-jacketed – double shell, totally enclosed	Similar to BHX260 but for higher compressive forces. Extremely robust.



### Buralloy heat exchanger seal

#### Features

Buralloy heat exchanger gaskets are manufactured using graphite, non-asbestos sheet and non-ceramic fiber as the filler, which are then jacketed by various metals such as stainless steel, tin or copper.

#### Advantages

Especially suitable for static sealing under high temperature and high pressure in heat exchangers or pressure vessels.

#### Operating range

Pressure and temperature in accordance with customer specifications. Corrosion resistance is dependent upon the choice of materials.

#### Forms of supply

Size to suit individual requirements, generally in accordance with ASME or DIN standards. Heat exchangers, API standard flanges, cylinder heads and boilers and pressure vessels. Please specify your required standard or specific drawing especially if the gasket is used on an heat exchanger with reinforcing ribs.

#### Recommended applications

- Process industry
- Oil and gas industry
- Petrochemical industry
- Chemical industry
- Power plant technology
- Building services industry
- Heat exchangers
- Reactor vessels
- Process vessels

#### Examples of Heat Exchanger gasket locations

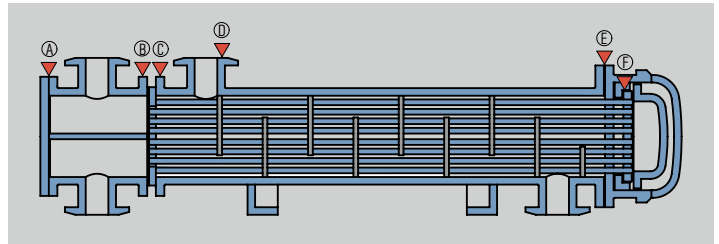

- A Channel box cover
- B Tube sheet/channel cover
- C Shell/tube sheet
- D Flanges
- E Shell cover
- F Floating head

#### Heat exchanger gaskets profiles

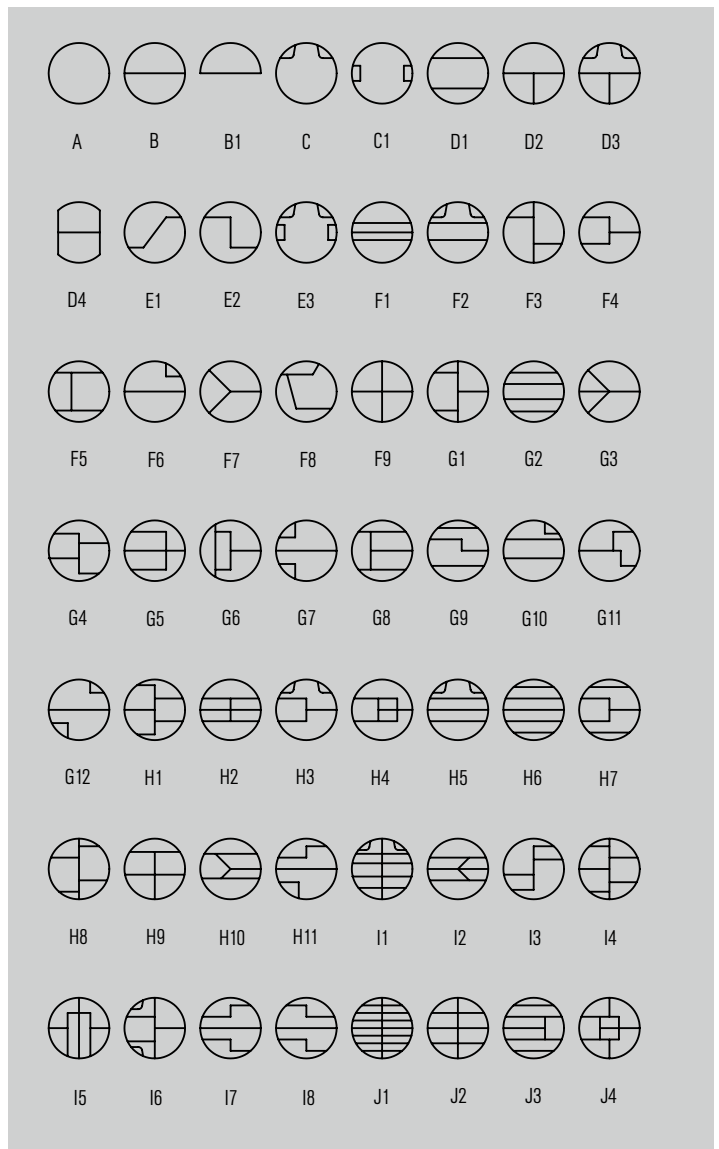

Heat exchanger gaskets are available in the following gasket forms:

- Cut gaskets from fiber or graphite sheet material
- Spiraltherm Spiral wound gaskets
- Corratherm gaskets
- Kammprofile gaskets
- Buralloy jacketed gaskets

# Ring type joints



**Buralloy ring type joint 2961**

## Features

Ring type joints are manufactured according to ASME B16.20 (2007) standards and to API specification 6A and 17B. Careful control of all manufacturing processes ensures correct surface hardness to give a good seal without damaging flange connections.

## Advantages

- Secure sealing action through metal-to-metal contact for reliable sealing in high-pressure applications
- They are used in the oil field on drilling and completion equipment and in downstream refinery applications. Ring type joints are also commonly used on extremely high-pressure valves and pipework assemblies, along with some high integrity pressure vessel joints

## Operating range

ASME B16.47 series A/B (ANSI B16.5): class 150 ASME B16.20 (API 6A): class 2,000

## Materials

RTJs are available in soft iron, 304 and 316 stainless steels as standard. Other materials are available on request.

## Forms of supply

RTJs are available to suit all ASME and DIN flanges from stock – 1/2" to 36" and 15 mm to 900 mm. Larger size and special requirements are available to order.

## Recommended applications

- Oil and gas industry
- Petrochemical industry
- Power plant technology
- Corrosion resistance is dependent upon the choice of ring material
- Flange connections
- Pipe connections

## Standards and approvals

All ring type joints are manufactured according to API standards, thereby providing certified reliability.

## Functional description

Under axial compressive load, ring type joints plastically deform and flow into the irregularities of the flange groove. Since the load bearing area of the ring type joint is relatively small, very high surface stresses result between the sealing faces of the ring type joint and the groove. These stresses are further increased on the style RX and BX rings which allow very high internal pressures to be sealed. Since ring type joints are solid metal, their recovery characteristics are poor. The seal is maintained by the action of axial load upon the gasket.

Material	Identification	DIN specification	DIN material No.	B.S.	AIS-ASTM UNS	Maximum hardness	
						Brinell HB	Rockwell B HRB
Soft iron	D	–	1.1003	–	–	90	56
Low carbon steel	S	R st 37.2	–	–	–	120	68
F5	F5	5 Cr 0.5 mo	1.7362	–	A 182FS	130	72
SS 304	S304	X5Cr Ni 18	1.4301	304S15/16/13	304	160	83
SS 304L	S304L	X2 Cr Ni 18.9	1.4306	304S11	304L	160	83
SS309	S309	X15 Cr Ni Si 20.12	1.4828	304S24	309	160	83
SS 316	S316L	X5 Cr Ni Mo 18.10	1.4401	316S16	316	160	83
SS 316L	S316L	X2 Cr Ni Mo 18.10	1.4404	316S11/13	316L	160	83
SS 316Ti	S316Ti	X10 Cr Ni Mo Ti 18.10	1.4571	320S31	316Ti	160	83
SS 321	S321	X10 Cr Ni Ti 18.9	1.4541	321S12/49/87	321	160	83
SS 347	S347	X10 Cr Ni Nb 18.9	1.4550	347S31	347	160	83
SS 410	S410	X6 Cr 13	1.4000	410S21	410	170	86
254SMO	S 254	X1 Cr Ni Mo Cu N 20.18.7	1.4547	–	S31254	180	89
Duplex	S 803	X2 Cr Ni Mo N 22.5.3	1.4462	31853	S31803/32205	230 approx.	99
Super duplex	S 750	X2 Cr Ni Mo N 25.6.3	1.4410	–	S32750	230 approx.	99
Aluminium	AL 1050	Al 99.5	3.0255	1B	A91050	30	–
Silver	Ag	–	–	–	–	28 (HV)	–
Copper	Cu	SF-CU	2.0090	CI06	C12200	80 approx.	–
Brass	CuZn37	Cu Za 37 (M563)	2.0321	CZ108	C27200	60 approx.	–
Nickel 200	Ni 200	Ni 99.2	2.4066	3072-70 NA11	NO2200	110	62
Monel® 400	N 400	Ni Cu 30 Fe	2.4360	3072-76 NA13	NO4400	150	80
Inconel® 600	N 600	Ni Cu 15 Fe	2.4816	3072-76 NA14	NO6600	150	80
Inconel® 625	N 625	Ni Cr 22 Mo 9 Mb	2.4856	3072-76 NA21	NO6625	150	80
Incoloy® 800	N 800	X10 Ni Cr Al Ti 3220	1.4876	3072-76 NA15	NO8800	150	80
Incoloy® 825	N 825	Ni Cr 21 Mo	2.4858	3072-76 NA16	NO8825	195	92
Hastelloy® B2	B2	Ni Mo 28	2.4617	–	NI0665	230	99
Hastelloy® C276	C276	Ni Mo 16 Cr 15W	2.4819	–	NI0276	210	95
Type 904	N 904	X1 Ni Cr Mo Cu 25.20.5	1.7440	904S13	NO8904	160	83
Titanium	Ti2	Ti 99.8	3.7025	TA2	R50400	–	–

## Buralloy ring type joints according to the "R" standard

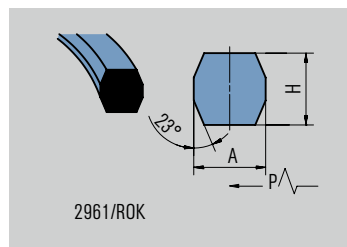
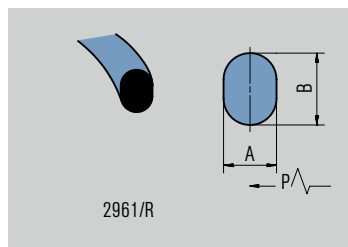

### Tolerances (inches)

A (width of ring)	±0.008
B, H (height of ring)	±0.020
P (average pitch diameter of ring)	±0.007
23° (angle)	±0.5°

### Buralloy ring type joint 2961/R

Style R ring type joints are manufactured in oval (2962/R) and octagonal profiles (2961/ROK). Both styles are interchangeable in the modern flat-bottomed groove. Octagonal profile joints are interchangeable on flat-bottomed

groove flanges which have a 23° angle groove wall. Style R ring type joints are designed to seal pressures up to 6,250 PSI (425 bar) in accordance with ASME B 16.5 ratings and up to 5,000 PSI (340 bar) in accordance with API 6A pressure ratings.

## Buralloy ring type joints according to the "RX" standard

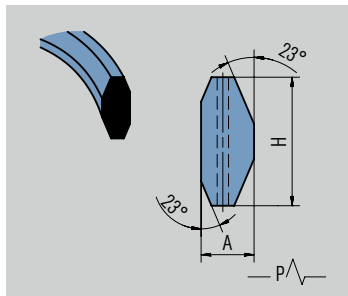

### Tolerances (inches)

A (width of ring)	+0.008 ... 0.000
B, H (height of ring)	+0.008 ... 0.000
OD (outside diameter of ring)	+0.020 ... 0.000
23° (angle)	±0.5°

### Buralloy ring type joint 2961/RX

Designed for pressures up to approx. 10,000 PSI (700 bar). This is self-sealing that uses a pressure-energized effect. The Style RX ring type joint is manufactured in accordance with API 6A and ASME B 16.20, to suit API 6B and ASME B 16.5 flanges. The Style RX is designed to fit the modern flat-bottom groove, and is interchangeable with the standard Style R ring type joint. However, since the Style RX is significantly taller than a Style R, larger flange make-up distances will result.

Style RX ring type joints are designed to seal pressures up to 6,250 PSI (425 bar) in accordance with ASME B16.5 pressure ratings, and up to 5,000 PSI (340 bar) in accordance with API 6A pressure ratings. Selected sizes incorporate a pressure passage hole to allow for pressure equalization each side of the sealing faces.

## Buralloy ring type joints according to the "BX" standard

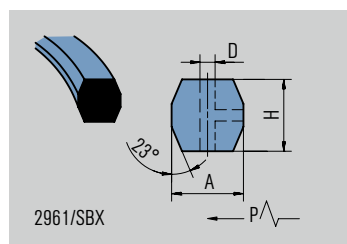
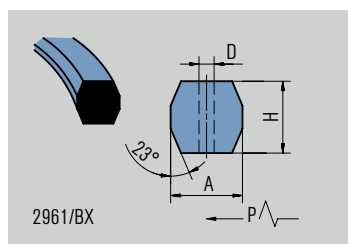

### Tolerances (inches)

A (width of ring)	+0.008 ... 0.000
D (hole size)	±0.02
H (height of ring)	+0.008 ... 0.000
OD (outside diameter of ring)	+0.000 ... 0.006
23° (angle)	±0.25°

### Buralloy ring type joint 2961/BX

The Style BX ring type joint is manufactured in accordance with API 6A. All BX ring type joints incorporate a pressure passage hole to allow for pressure equalization each side of the sealing faces. On assembly, metal-to-metal contact of the flange faces is achieved. The Style BX is not interchangeable with any other style and is only suited for

API 6BX flanges. Style BX ring type joints are designed to seal pressures up to 20,000 PSI (1,360 bar) in accordance with API 6A pressure ratings. Styles SRX and SBX are derived from Styles RX and BX and are produced in line with the API Standard 17 D for use on subsea wellhead and Christmas tree equipment.

# Rubber-steel gaskets



**KH rubber-steel gasket 9107/KH**

## Features

Rubber-steel gasket for load bearing connections. Metal support ring completely jacketed with rubber gives added strength while ensuring perfect sealing at lower bolt loads for large bore flanges.

## Advantages

- The metal core increases the stability of the gasket and results in better blow-out safety
- Due to the spherical elastomer body the precompression can be reduced and still give better sealability
- This gasket can also be used for fragile components like plastic flanges

## Operating range

Pressure:  $p = 25 \text{ bar}$

Temperature:

$t = -30 \text{ °C} \dots +120 \text{ °C}$  (EPDM)

$t = -25 \text{ °C} \dots +70 \text{ °C}$  (NBR)

$t = -20 \text{ °C} \dots +200 \text{ °C}$  (FPM)

## Forms of supply

Complete seal with support ring made of stainless steel 37.

Sizes acc. to EN 1514-1 or EN 12560-1.

## Recommended applications

- Power plant industry
- Water and waste water industry
- Building services industry
- Flange connections
- Pipe connections

## Notes

Other ring materials and elastomeric materials available.



**KN rubber-steel gasket 9107/KN**

## Features

Replaceable EPDM sealing lip, mounted on metal supporting ring which performs both a centering and a load-restricting function. It absorbs the tightening forces necessary for high pressures while protecting the rubber seal from excessive compression. With coated flanges we recommend selecting an outside diameter of coating that permits the sealing lip on the atmosphere side to lie within the area of the steel. If necessary, please discuss exact sizes with EagleBurgmann.

## Advantages

- The supporting ring does not come into contact with the medium. Uniform distribution of stresses is guaranteed by special sealing lip geometry combined with elastomer of the highest quality
- The permissible contact pressures and transverse loads, which are a vital factor in soft rubberized flanges, are not exceeded
- For flange connections with flat faces in all areas of industry, e.g. general piping, process equipment and pipe flanges made of plastics and glass, also rubber-coated steel flanges, waste exhaust treatment plants with rubber-coated flanges and tubes

## Operating range

Pressure:  $p = 64 \text{ bar}$

Temperature:  $t =$  temperature resistance EPDM

Sustained operation:  $-30 \text{ °C} \dots +130 \text{ °C}$ ,  
a few hours:  $-30 \text{ °C} \dots +150 \text{ °C}$ ,  
a few minutes:  $-30 \text{ °C} \dots +200 \text{ °C}$

## Forms of supply

Complete seal with supporting ring made of St 37.

Other ring materials and elastomeric materials available.

## Recommended applications

- Power plant technology
- Water and waste water technology
- Building services industry

- Flange connections
- Pipe connections

## Materials

Sealing ring EPDM metal supporting ring (stainless steel 37 galvanized and chromated)

## Notes

Note to fabrication:

up to DN 800 or 32" the sealing lips are manufactured by injection molding. The higher dimensional accuracy achieved by injection molding makes it superior to the frequently applied method of production by displacement with an open compression mold. For diameters  $> \text{DN } 800$  the sealing lips are extruded and their joints vulcanized to form the sizes needed for installation. Recommended surface roughness  $R_z \leq 100 \text{ }\mu\text{m}$ .

Generally: the smoother the surface, the higher the achievable tightness.

## Sealing characteristics (N/mm<sup>2</sup>)

$$q_{vu} = 2 \quad q_{v0} = 10 \quad m = 1.3$$

## Load values (q)

**Elastomer gasket:** The surface load with the flange in locked position is

$q_{\text{max}} =$  approx.  $10 \text{ N/mm}^2$  at room temp.

$q_{\text{max}} =$  approx.  $6 \text{ N/mm}^2$  at  $100 \text{ °C}$

## Sealing face requirements

Recommended surface roughness  $R_z = \leq 100 \text{ }\mu\text{m}$ . As a basic rule: The finer the surface, the tighter the seal.

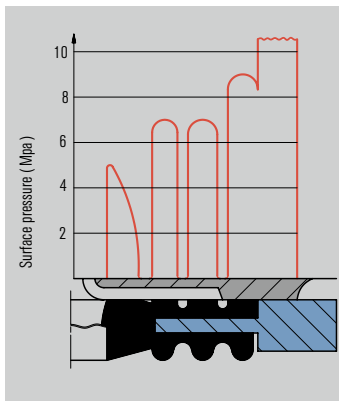

Distribution of contact forces with an EagleBurgmann 9107/KN gasket in a non-load bearing, rubberized flange connection.



### Forms of supply

Up to DN 600 or 24" the gasket is manufactured as a single unit.  
For diameters >DN 600 the gasket is manufactured in easily transported segments and assembled on site.

### Recommended applications

- Power plant industry
- Water and waste water industry
- Building services industry
- Flange connections
- Pipe connections

### KN rubber-PVC gasket 9117/KN

#### Features

The KN Rubber-PVC gasket consists of a PVC supporting ring and a specially shaped, renewable, inner elastomer seal for installation in non-load-bearing positions in large bore pipework.

#### Advantages

The advantages of a PVC support ring:

- Reduced weight for large gaskets
- Easier handling and transportation
- Gasket can be made to suit almost any diameter of pipe
- Lower overall installed cost when compared to conventional steel gasket

#### Operating range

p = 25 bar  
t = -30 °C ... +130°C (sustained )

#### Materials

Inner seal – EPDM elastomer  
Outer ring – PVC

### Functional description

The EPDM sealing lip is mounted in the PVC supporting ring which performs both a centering and a load-restricting function. It absorbs the tightening forces necessary for high pressures while protecting the rubber seal from excessive compression. The PVC supporting ring does not come into contact with the medium.

### Notes

Note for fabrication:  
up to DN 800 or 32" the sealing lips are manufactured by injection molding. The higher dimensional accuracy achieved by injection molding makes it superior to the frequently applied method of production by displacement with an open compression mold. For diameters >DN 800 the sealing lips are extruded and their joints vulcanized to form the sizes needed for installation. Recommended surface roughness Rz ≤100 µm.  
Generally: the smoother the surface, the higher the achievable tightness.

Materials	Support ring Sealing element	9107/KH	9107/KN	9117/KN
		Carbon steel EPDM	Galvanized carbon steel EPDM	PVC EPDM
Design		Carbon steel inner ring encapsulated in rubber	Galvanized, carbon steel support ring; renewable EPDM profiled inner sealing ring. <DN800 (32") EPDM is injection molded. >DN800 (32") EPDM is extrusion, vulcanized.	Machined PVC support ring; renewable EPDM profiled inner sealing ring. <DN800 (32") EPDM is injection molded. >DN800 (32") EPDM is extrusion, vulcanized.
Operating pressure (max.)		64 bar	64 bar	25 bar
Temperature °C		-30 °C ... +130 °C	EPDM seal element: sustained -30 °C ... +130 °C, up to 1 hour -30 °C ... +150 °C, up to 1 minute -30 °C ... +200 °C, (transient peak )	-30 °C ... +130 °C (sustained)
Application		Flat-face flange connections, especially plastic or glass-lined pipework and coated (rubberized) steel flanges. Ideal for flue gas desulphurization plant pipework systems.	Flat-face flange connections, especially plastic or glass-lined pipework and coated (rubberized) steel flanges. Ideal for flue gas desulphurization plant pipework systems.	Flat-face flange connections, especially plastic or glass-lined pipework and coated (rubberized) steel flanges.
Supply form		All sizes available for standard flange connections to DIN, ANSI, BS, JIS	All sizes available for standard flange connections to DIN, ANSI, BS, JIS	All sizes available for standard flange connections to DIN, ANSI, BS, JIS Support ring: <DN 600 – one piece construction >DN 600 – segmented (site assembly)

# Tools, maintenance products



**Gasket cutter 9614**

## Features

The gasket cutter consists of a base plate to cut on, a short and a long bar with a sliding cutting tool. The sealing material is fixed by the central bolt. The tools to punch the central hole are easy to use. After fixing the sealing material on the base plate and adjusting the cutting diameter on the bar, the gasket is cut by rotating the cutting tool.

## Advantages

Especially suitable to produce small quantities of gaskets from sheet materials. An easy-to-handle special tool. Also suitable for rubber, plastics and other materials; from inner diameter 30 mm up to outer diameter 1,000 mm.



**Joudol >SM 8152<**

## Features

Graphite-based lubricant and release agent.

## Advantages

Universal high-duty lubricant and anti-seize agent with a graphite base. Prevents seals from sticking and baking to surfaces. Keeps screw threads movable.

## Operating range

Temperature: t = resistant from -200 °C up to +500 °C

## Forms of supply

Can: 1 kg  
Tube: 230 g



**Gasket nibbler 9615**

## Features

The complete equipment consists of an aluminium base plate, a nibbler with holding device, a parallel stop, a release key to change the cutting knives, a spare knife, two clamps, a punching tool, a plate to punch on as well as a pair of scissors to cut sealing material (prepare smaller pieces from sheet material by hand).

## Advantages

Tool for gasket cutting from sheet materials with or without metal reinforcement in smaller quantities. With this nibbler any gasket form can be cut, not only rings. Ideally for quick repair service and on-site cutting.

## Operating range

Voltage: 230 V  
Strokes: 100 mm min.  
Min. seal diameter: approx. 60 mm  
Max. seal diameter: approx. 1,500 mm  
Seal thickness: 3 mm max.  
Max. thickness of metal inlay: 0.2 mm

## Forms of supply

Set/spare parts



# Gasket parameters to EN 13555 (sample thickness = 2 mm)

## Fiber sheet

Tightness class			9544/B Burasil Basic aramid/NBR				9544/U Burasil Universal aramid/NBR				9544/N Buratherm N aramid/graphite/NBR				
			L <sub>1,0</sub>	L <sub>0,1</sub>	L <sub>0,01</sub>	L <sub>0,001</sub>	L <sub>1,0</sub>	L <sub>0,1</sub>	L <sub>0,01</sub>	L <sub>0,001</sub>	L <sub>1,0</sub>	L <sub>0,1</sub>	L <sub>0,01</sub>	L <sub>0,001</sub>	
Q <sub>MIN(L)</sub> (N/mm <sup>2</sup> ) at room temperature <sup>a</sup>	10	P <sub>i</sub> (bar)	<5	7	14	35	<5	6	<10	<20	<5	<5	22	63	
	20		<10	10	26	54	<10	<10	11	<20	<10	<10	32	70	
	40		<10	16	35	69	<10	11	22	33	<10	<10	46		
	80		<20	22	49		<20	<20	35	47	<20	<10	36		
Q <sub>S(MIN(L))</sub> (N/mm <sup>2</sup> ) at room temperature	Q <sub>A</sub> (N/mm <sup>2</sup> )	P <sub>i</sub> = 10 bar	<5	<5	<5		<5	<5	<5		<5	<5			
			40	<5	<5	<5	8	<5	<5	<5	6	<5	<5	6	
			60	<5	<5	<5	<5	<5	<5	<5	<5	<5	<5	<5	
			80	<5	<5	<5	<5	<5	<5	<5	<5	<5	<5	<5	13
	Q <sub>A</sub> (N/mm <sup>2</sup> )	P <sub>i</sub> = 20 bar	<10	<10			<10	<10	<10		<5	<5			
			40	<10	<10	<10		<10	<10	<10	<10	<5	<5	15	
			60	<10	<10	<10	18	<10	<10	<10	<10	<5	<5	<10	
			80	<10	<10	<10	<10	<10	<10	<10	<10	<5	<5	<10	21
	Q <sub>A</sub> (N/mm <sup>2</sup> )	P <sub>i</sub> = 40 bar	<10	<10			<10	<10			<10	<10			
			40	<10	<10	<10		<10	<10	<10	16	<10	<10		
			60	<10	<10	<10		<10	<10	<10	<10	<10	<10	16	
			80	<10	<10	<10	16	<10	<10	<10	<10	<10	<10	<10	
Q <sub>A</sub> (N/mm <sup>2</sup> )	P <sub>i</sub> = 80 bar	<10	<10			<10	<10			<10	25				
		40	<10	<10			<10	<10	17		<10	<10			
		60	<10	<10	12		<10	<10	<10	18	<10	<10			
		80	<10	<10	<10		<10	<10	<10	17	<10	<10	55		

Q <sub>S(MIN(L))</sub> (N/mm <sup>2</sup> )			9544/B Burasil Basic aramid/NBR				9544/U Burasil Universal aramid/NBR				9544/N Buratherm N aramid/graphite/NBR			
			RT	100	200	300	RT	100	200	300	RT	100	200	300
Q <sub>S(MIN(L))</sub> (N/mm <sup>2</sup> )			>220	200	160		>220	120	80		>220	120	80	60
P <sub>OR</sub> stiffness 500 kN/mm	Q <sub>A</sub> (N/mm <sup>2</sup> )	30 = 10	0.94	0.92	0.9		0.96	0.87	0.82		0.95	0.89	0.85	0.75
		50 = 25	0.95	0.91	0.84		0.96	0.84	0.74		0.97	0.91	0.88	0.8
		Q <sub>S(MIN(L))</sub>	0.98	0.84	0.75		0.96	0.73	0.68					
E <sub>G</sub> (N/mm <sup>2</sup> )	Q <sub>A</sub> (N/mm <sup>2</sup> )	10	1,791	1,124	840		1,356	987	856					
		20	1,952	1,276	975		1,576	1,185	1,038		1,002	1,055	1,092	2,039
		30	2,114	1,427	1,109		1,796	1,384	1,219					
		40	2,275	1,578	1,243		2,016	1,582	1,401		1,540	1,643	1,722	2,764
		50	2,437	1,729	1,377		2,236	1,781	1,583					
		60	2,598	1,880	1,511		2,456	1,979	1,765		2,077	2,231	2,353	3,490
		70	2,760	2,031	1,645		2,676	2,177	1,946					
		80	2,921	2,183	1,779		2,896	2,376	2,128		2,615	2,819	2,983	
		100	3,244	2,485	2,047		3,335	2,773			3,153	3,407		
		120	3,567	2,787	2,316		3,775	3,169			3,691	3,995		
		140	3,890	3,090	2,584		4,215				4,228			
		160	4,213	3,392	2,852		4,655							
		180	4,536	3,694			5,095							
200	4,859	3,997			5,534									
220	5,182				5,974									

### Q<sub>S(MIN(L))</sub>

Maximum surface pressure that may be imposed on the gasket at the indicated temperatures without collapse or compressive failure of the gasket.

### Q<sub>MIN(L)</sub>

Minimum gasket surface pressure on assembly required at ambient temperature in order to seat the gasket into the flange facing roughness and close the internal leakage channels so that the tightness class achieved is to the required level **L** for the internal test pressure.

### L<sub>N</sub>

Tightness classes are defined in terms of specific leakage rates.

Tightness class: L<sub>1,0</sub>      L<sub>0,1</sub>      L<sub>0,01</sub>  
 Specific leakage rate: ≤1.0      ≤0.1      ≤0.01  
 (mg s<sup>-1</sup> m<sup>-1</sup>)

### Q<sub>S(MIN(L))</sub>

Minimum gasket surface pressure required under the service pressure conditions to maintain the required tightness class for the internal application pressure.

### P<sub>OR</sub>

Factor to simulate the effect of gasket relaxation after bolt tightening with long-term exposure to service temperatures.

# Gasket parameters to EN 13555 (sample thickness = 2 mm)

## Graphite sheet

Tightness class			9593/1P Statotherm 1P 98 % graphite, 316 L stainless steel foil, adhesive bonded				9593/HDP Statotherm HDP 99.85 % graphite, stainless steel foil				9592/P Statotherm SSTC-TAL 99 % graphite, stainless steel expanded metal reinforcement			
			L <sub>1.0</sub>	L <sub>0.1</sub>	L <sub>0.01</sub>	L <sub>0.001</sub>	L <sub>1.0</sub>	L <sub>0.1</sub>	L <sub>0.01</sub>	L <sub>0.001</sub>	L <sub>1.0</sub>	L <sub>0.1</sub>	L <sub>0.01</sub>	L <sub>0.001</sub>
Q <sub>MIN(L)</sub> (N/mm <sup>2</sup> ) at room temperature	10	P <sub>i</sub> (bar)	<10	<10	22		<10	13		<5	7	10	34	
	20		<10	<10	32		<10	<20		<5	9	19	48	
	40		<10	11	53	113	<10	30		6	11	23	61	
	80									<10	14	34	66	
Q <sub>S</sub> (N/mm <sup>2</sup> ) at room temperature	20	P <sub>i</sub> = 10 bar	<10	<10			<10	<10		<5	<5	<5		
	40		<10	<10	<10		<10	<10		<5	<5	<5	20	
	60		<10	<10	<10		<10	<10		<5	<5	<5	7	
	80		<10	<10	<10		<10	<10		<5	<5	<5	<5	
	20	P <sub>i</sub> = 20 bar	<10	<10			<10	<10		<5	<5	17		
	40		<10	<10			<10	<10		<5	<5	<5		
	60		<14	<10			<10	<10		<5	<5	<5	31	
	80		<10	<10			<10	<10		<5	<5	<5	12	
	20	P <sub>i</sub> = 40 bar	<10	<10			<10	<10		<5	<5			
	40		<10	<10			<10	<10	15	<5	<5	7		
	60		<10	<10	44		<10	<10	<10	<5	<5	<5		
	80		<10	<10	23		<10	<10	<10	47	<5	<5	<5	23
100	<10		<10	14		<10	<10	<10	23					
120	<10		<10			<10	<10	<10						
140	<10	<10			<10	<10	<10							
160	<10	<10			<10	<10	<10							
20	P <sub>i</sub> = 80 bar								<10	<10				
40									<10	<10	22			
60									<10	<10	<10			
80									<10	<10	<10	41		

Q <sub>SMAX</sub> (N/mm <sup>2</sup> )			9593/1P Statotherm 1P 98 % graphite, 316 L stainless steel foil adhesive bonded				9593/HDP Statotherm HDP 99.85 % graphite, stainless steel foil				9592/P Statotherm SSTC-TAL 99 % graphite, stainless steel expanded metal reinforcement				
			RT	150	300		RT	150	300		RT	100	200	300	400
Q <sub>SMAX</sub> (N/mm <sup>2</sup> )			200	100	100		>200	>200	>200		200	180	160	160	160
P <sub>05</sub> stiffness 500 kN/mm	Q <sub>s</sub> (N/mm <sup>2</sup> )	30 = 10	0.97	0.95	0.95		0.98	0.96	0.93		0.98	0.94	0.93	0.92	0.91
		50 = 25	0.98	0.97	0.97		0.98	0.98	0.96						
		Q <sub>SMAX</sub>	1.00	0.98	0.98		1.00	1.00	0.99						
E <sub>G</sub> (N/mm <sup>2</sup> )	Q <sub>s</sub> (N/mm <sup>2</sup> )	10									152	217	67	231	324
		20	324	416	552		370	399	454		450	527	383	499	575
		30	517	655	669		548	644	722		748	838	700	767	826
		40	711	776	769		881	907	997		1,046	1,148	1,016	1,034	1,077
		50	937	1,017	1,113		1,005	1,085	1,262		1,344	1,459	1,332	1,302	1,328
		60	1,129	1,289	1,223						1,641	1,769	1,648	1,570	1,579
		70									1,939	2,080	1,964	1,838	1,829
		80	1,680	1,667	1,678		1,996	1,805	2,119		2,237	2,390	2,280	2,106	2,080
		100	1,793	1,704	1,691		1,970	2,231	2,057		2,833	3,011	2,912	2,642	2,582
		120	2,072	2,674	2,893		2,455	2,578	2,416		3,428	3,632	3,545	3,178	3,084
		140	2,496	3,149	2,981		2,927	2,828	2,788		4,024	4,253	4,177	3,713	3,585
		160	2,822	3,675			3,031	2,734	3,135		4,620	4,874	4,809	4,249	4,087
		180	2,694				2,958	3,301	3,340		5,215	5,495			
200	3,190				3,161	3,480	3,273		5,811						
220															

**PTFE sheet**

Tightness class			9654/MP Burachem Multi Expanded virgin PTFE				9655/B Burachem B PTFE/glass microspheres				9655/R Burachem R PTFE/silica				9655/W Burachem W PTFE/barium sulphate				
			L <sub>1.0</sub>	L <sub>0.1</sub>	L <sub>0.01</sub>	L <sub>0.001</sub>	L <sub>1.0</sub>	L <sub>0.1</sub>	L <sub>0.01</sub>	L <sub>0.001</sub>	L <sub>1.0</sub>	L <sub>0.1</sub>	L <sub>0.01</sub>	L <sub>0.001</sub>	L <sub>1.0</sub>	L <sub>0.1</sub>	L <sub>0.01</sub>	L <sub>0.001</sub>	
Q <sub>MIN(L)</sub> (N/mm <sup>2</sup> ) at room temperature	10	P <sub>i</sub> (bar)					<5	6	8	11	6	10	13	16	5	8	11	14	
	20		14.7				6	8	<10	13	<10	10	13	16	<10	<10	12	15	
	40		14.7	22.1	29.7	37.2	<10	<10	11	15	10	14	18	24	10	13	16	18	
	80		14.7	22.1	29.7	37.2					<20	<20	<20	28	<20	21	25	29	
Q <sub>s</sub> (N/mm <sup>2</sup> ) at room temperature	Q <sub>s</sub> (N/mm <sup>2</sup> )	P <sub>i</sub> = 10 bar	20				<5	<5	<5	<5	<5	<5	<5	8	<5	<5	<5	<5	
			40				<5	<5	<5	<5	<5	<5	<5	<5	<5	<5	<5	<5	<5
			60				<5	<5	<5	<5	<5	<5	<5	<5	<5	<5	<5	<5	<5
			80				<5	<5	<5	<5	<5	<5	<5	<5	<5	<5	<5	<5	<5
	Q <sub>s</sub> (N/mm <sup>2</sup> )	P <sub>i</sub> = 20 bar	20				<5	<5	<5	<5	<10	<10	<10	<10	<10	<10	<10	<10	
			40				<5	<5	<5	<5	<10	<10	<10	<10	<10	<10	<10	<10	
			60				<5	<5	<5	<5	<10	<10	<10	<10	<10	<10	<10	<10	
			80				<5	<5	<5	<5	<10	<10	<10	<10	<10	<10	<10	<10	
	Q <sub>s</sub> (N/mm <sup>2</sup> )	P <sub>i</sub> = 40 bar	20	10			<10	<10	<10	<10	<10	<10	16		<10	<10	<10	15	
			40	10	10	10	29.4	<10	<10	<10	<10	<10	<10	<10	<10	<10	<10	<10	
			60	10	10	10	10	<10	<10	<10	<10	<10	<10	<10	<10	<10	<10	<10	
			80	10	10	10	10	<10	<10	<10	<10	<10	<10	<10	<10	<10	<10	<10	
	Q <sub>s</sub> (N/mm <sup>2</sup> )	P <sub>i</sub> = 80 bar	20								<10	<10	<10	<10	<10	<10	<10	<10	
			40								<10	<10	<10	<10	<10	<10	<10	<10	
			60								<10	<10	<10	<10	<10	<10	<10	<10	
			80								<10	<10	<10	<10	<10	<10	<10	<10	

# Flat-cut gaskets dimensions (acc. to EN1514-1:1997)

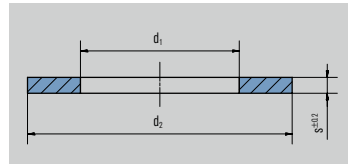
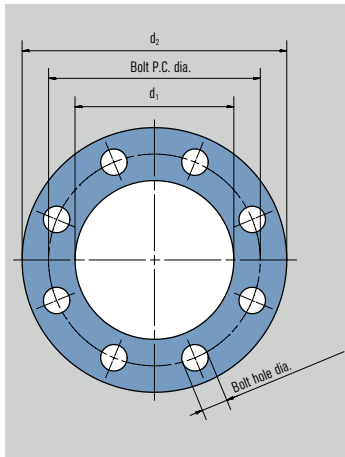

## Dimensions of flat gaskets to EN 1514-1 (1997), raised face

Gasket style		Style IBC (inner bolt circle)						Style SR (surface rebate)	Style TG (tongue & groove)			
Pressure class nominal width		PN 2,5	PN 6	PN 10	PN 16	PN 25	PN 40	PN 63		PN 10 – 40		
DN	d <sub>1</sub> (mm)	d <sub>2</sub> (mm)						d <sub>1</sub> (mm)	d <sub>2</sub> (mm)	d <sub>2</sub> (mm)	d <sub>1</sub> (mm)	d <sub>2</sub> (mm)
	10	18	39			46			18	56	34	24
15	22	44			51			21	61	39	29	39
20	27	54			61			25	72	50	36	50
25	34	64			71			30	82	57	43	57
32	43	76			82			41	88	65	51	65
40	49	86			92			47	103	75	61	75
50	61	96			107			59	113	87	73	87
60	72	106			117			68	123	-	-	-
65	77	116			127			73	138	109	95	109
80	89	132			142			86	148	120	106	120
100	115	152		162		168		110	174	149	129	149
125	141	182		192		194		135	210	175	155	175
150	169	207		218		224		163	247	203	183	203
200	220	262		273	284	290		210	309	259	239	259
250	273	317		328	340	352		264	364	312	292	312
300	324	373		378	384	400	417	314	424	363	343	363
350	356	423		438	444	457	474	360	486	421	395	421
400	407	473		489	495	514	546	415	543	473	447	473
450	458	528		539	555	564	571	-	-	523	497	523
500	508	578		594	617	624	628	-	-	575	549	575
600	610	679		695	734	731	747	-	-	675	649	675
700	712	784		810	804	833	-	-	-	777	751	777
800	813	890		917	911	942	-	-	-	882	856	882
900	915	990		1,017	1,011	1,042	-	-	-	987	961	987
1,000	1,016	1,090		1,124	1,128	1,154	-	-	-	1,092	1,062	1,092
1,100	1,120	-	-	1,231	1,228	1,254	-	-	-	-	-	-
1,200	1,220	1,290	1,307	1,341	1,342	1,364	-	-	-	-	-	-
1,400	1,420	1,490	1,524	1,548	1,542	1,578	-	-	-	-	-	-
1,500	1,520	-	-	1,658	1,654	1,688	-	-	-	-	-	-
1,600	1,620	1,700	1,724	1,772	1,764	1,798	-	-	-	-	-	-
1,800	1,820	1,900	1,931	1,972	1,964	2,000	-	-	-	-	-	-
2,000	2,020	2,100	2,138	2,182	2,168	2,230	-	-	-	-	-	-
2,200	2,220	2,307	2,348	2,384	-	-	-	-	-	-	-	-
2,400	2,420	2,507	2,558	2,594	-	-	-	-	-	-	-	-
2,600	2,620	2,707	2,762	2,794	-	-	-	-	-	-	-	-
2,800	2,820	2,924	2,972	3,014	-	-	-	-	-	-	-	-
3,000	3,020	3,124	3,172	3,228	-	-	-	-	-	-	-	-
3,200	3,220	3,324	3,382	-	-	-	-	-	-	-	-	-
3,400	3,420	3,524	3,592	-	-	-	-	-	-	-	-	-
3,600	3,620	3,734	3,804	-	-	-	-	-	-	-	-	-
3,800	3,820	3,931	-	-	-	-	-	-	-	-	-	-
4,000	4,020	4,131	-	-	-	-	-	-	-	-	-	-

### Dimensions of gaskets to EN 1514-1 (1997), full face

Flange nominal size DN	d <sub>1</sub>	PN 2.5/6				PN10				PN 16				PN 25				PN 40			
		d <sub>2</sub>	bolt holes		Bolt circle diameter	d <sub>2</sub>	bolt holes		Bolt circle diameter	d <sub>2</sub>	bolt holes		Bolt circle diameter	d <sub>2</sub>	bolt holes		Bolt circle diameter	d <sub>2</sub>	bolt holes		Bolt circle diameter
			Number	Dia-meter			Number	Dia-meter			Number	Dia-meter			Number	Dia-meter			Number	Dia-meter	
10	18	75	4	11	50	90	4	14	60	90	4	14	60	90	4	14	60	90	4	14	60
15	22	80	4	11	55	95	4	14	65	95	4	14	65	95	4	14	65	95	4	14	65
20	27	90	4	11	65	105	4	14	75	105	4	14	75	105	4	14	75	105	4	14	75
25	34	100	4	11	75	115	4	14	85	115	4	14	85	115	4	14	85	115	4	14	85
32	43	120	4	14	90	140	4	18	100	140	4	18	100	140	4	18	100	140	4	18	100
40	49	130	4	14	100	150	4	18	110	150	4	18	110	150	4	18	110	150	4	18	110
50	61	140	4	14	110	165	4	18	125	165	4	18	125	165	4	18	125	165	4	18	125
60	72	150	4	14	120	175	8	18	135	175	8	18	135	175	8	18	135	175	8	18	135
65	77	160	4	14	130	185	8	18	145	185	8	18	145	185	8	18	145	185	8	18	145
80	89	190	4	18	150	200	8	18	160	200	8	18	160	200	8	18	160	200	8	18	160
100	115	210	4	18	170	220	8	18	180	220	8	18	180	235	8	22	190	235	8	22	190
125	141	240	8	18	200	250	8	18	210	250	8	18	210	270	8	26	220	270	8	26	220
150	169	265	8	18	225	285	8	22	240	285	8	22	240	300	8	26	250	300	8	26	250
200	220	320	8	18	280	340	8	22	295	340	12	22	295	360	12	26	310	375	12	30	320
250	273	375	12	18	335	395	12	22	350	405	12	26	355	425	12	30	370	450	12	33	385
300	324	440	12	22	395	445	12	22	400	460	12	26	410	485	16	30	430	515	16	33	450
350	356	490	12	22	445	505	16	22	460	520	16	26	470	555	16	33	490	580	16	36	510
400	407	540	16	22	495	565	16	26	515	580	16	30	525	620	16	36	550	660	16	39	585
450	458	595	16	22	550	615	20	26	565	640	20	30	585	670	20	36	600	685	20	39	610
500	508	645	20	22	600	670	20	26	620	715	20	33	650	730	20	36	660	755	20	42	670
600	610	755	20	26	705	780	20	30	725	840	20	36	770	845	20	39	770	890	20	48	795
700	712	-	-	-	-	895	24	30	840	910	24	36	840	960	24	42	875	-	-	-	-
800	813	-	-	-	-	1,015	24	33	950	1,025	24	39	950	1,085	24	48	990	-	-	-	-
900	915	-	-	-	-	1,115	28	33	1,050	1,125	28	39	1,050	1,185	28	48	1,090	-	-	-	-
1,000	1,016	-	-	-	-	1,230	28	36	1,160	1,255	28	42	1,170	1,320	28	56	1,210	-	-	-	-
1,100	-	-	-	-	-	1,340	32	39	1,270	1,355	32	42	1,270	1,420	32	56	1,310	-	-	-	-
1,200	1,220	-	-	-	-	1,455	32	39	1,380	1,485	32	48	1,390	1,530	32	56	1,420	-	-	-	-
1,400	1,420	-	-	-	-	1,675	36	42	1,590	1,685	36	48	1,590	1,755	36	62	1,640	-	-	-	-
1,500	-	-	-	-	-	1,785	36	42	1,700	1,820	36	56	1,710	1,865	36	62	1,750	-	-	-	-
1,600	1,620	-	-	-	-	1,915	40	48	1,820	1,930	40	56	1,820	1,975	40	62	1,860	-	-	-	-
1,800	1,820	-	-	-	-	2,115	44	48	2,020	2,130	44	56	2,020	2,195	44	70	2,070	-	-	-	-
2,000	2,020	-	-	-	-	2,325	48	48	2,230	2,345	48	62	2,230	2,425	48	70	2,300	-	-	-	-

### Dimensions of gaskets to EN 1256.1 and ASME B16.21 for full face flat gaskets

Gasket style		IBC (inner bolt circle)					FF (full face) only class 150					SR (surface rebate)	TG (tongue & groove)	
Pressure class		d <sub>1</sub>	Class 150	Class 300 d <sub>2</sub>	Class 600	Class 900	d <sub>2</sub>	Bolts			Bolt circle 150	Class 300 - 900	Class 300 - 900	
DN	Nominal bore							No. of bolt holes	Bolt hole (mm)	Bolt hole (in)			d <sub>2</sub>	d <sub>1</sub>
(mm)	(in)	(mm)	(mm)	(mm)	(mm)	(mm)	(mm)	(mm)	(in)	(mm)	(mm)	(mm)	(mm)	
15	1/2	22	47.5	54.0	63.5	89	4	15.9	5/8	60.3	35.0	25.5	35.0	
20	3/4	27	57.0	66.5	69.5	98	4	15.9	5/8	69.8	43.0	33.5	43.0	
25	1	34	66.5	73.0	79.0	108	4	15.9	5/8	79.4	51.0	38.0	51.0	
32	1 1/4	43	76.0	82.5	89.0	117	4	15.9	5/8	88.9	64.0	47.5	64.0	
40	1 1/2	49	85.5	95.0	98.0	127	4	15.9	5/8	98.4	73.0	54.0	73.0	
50	2	61	104.5	111.0	142.5	152	4	19.0	3/4	120.6	92.0	73.0	92.0	
65	2 1/2	73	124.0	130.0	165.0	178	4	19.0	3/4	139.7	105.0	85.5	105.0	
80	3	89	136.5	149.0	168.0	190	4	19.0	3/4	152.4	127.0	108.0	127.0	
100	4	115	174.5	181.0	193.5	206.0	229	8	19.0	3/4	190.5	157.0	132.0	157.0
125	5	141	196.5	216.0	241.0	247.5	254	8	22.2	7/8	215.9	186.0	160.5	186.0
150	6	169	222.0	251.0	266.5	289.0	279	8	22.2	7/8	241.3	216.0	190.5	216.0
200	8	220	279.0	308.0	320.5	358.5	343	8	22.2	7/8	298.4	270.0	238.0	270.0
250	10	273	339.5	362.0	400.0	435.0	406	12	25.4	1	362.0	324.0	286.0	324.0
300	12	324	409.5	422.0	457.0	498.5	483	12	25.4	1	431.8	381.0	343.0	381.0
350	14	356	450.5	485.5	492.0	520.5	533	12	28.6	1 1/8	476.2	413.0	374.5	413.0
400	16	407	514.0	539.5	565.0	574.5	597	16	28.6	1 1/8	539.8	470.0	425.5	470.0
450	18	458	549.0	597.0	612.5	638.0	635	16	31.8	1 1/4	577.8	533.0	489.0	533.0
500	20	508	606.5	654.0	682.5	698.5	698	20	31.8	1 1/4	635.0	584.0	533.5	584.0
600	24	610	717.5	774.5	790.5	838.0	813	20	34.9	1 3/8	749.3	692.0	641.5	692.0

# Flat gaskets dimensions (acc. to ASME B16.21 (2011))

## Dimensions of flat gaskets to ASME B16.21 (2011) for ASME B16.47, series A, raised-face flanges

Nominal Size		Inner diameter (mm)	Class			
DN (mm)	NPS (inch)		150 lbs	300 lbs	400 lbs	600 lbs
			Outside diameter (mm)			
550	22	559	660	705	702	734
650	26	660	775	835	832	867
700	28	711	832	899	892	914
750	30	762	883	953	946	972
800	32	813	940	1,006	1,003	1,022
850	34	864	991	1,057	1,054	1,073
900	36	914	1,048	1,118	1,118	1,130
950	38	965	1,111	1,054	1,074	1,105
1,000	40	1,016	1,162	1,114	1,127	1,156
1,050	42	1,067	1,219	1,165	1,178	1,219
1,100	44	1,118	1,276	1,219	1,232	1,270
1,150	46	1,168	1,327	1,273	1,289	1,327
1,200	48	1,219	1,384	1,324	1,346	1,391
1,250	50	1,270	1,435	1,378	1,403	1,448
1,300	52	1,321	1,492	1,429	1,454	1,556
1,350	54	1,372	1,549	1,492	1,518	1,556
1,400	56	1,422	1,607	1,543	1,569	1,613
1,450	58	1,473	1,664	1,594	1,619	1,664
1,500	60	1,524	1,715	1,645	1,683	1,734

## Dimensions of flat gaskets to ASME B16.21 (2011) for ASME B16.47, series B, raised-face flanges

Nominal Size		Inner diameter (mm)	Class				
DN (mm)	NPS (inch)		75 lbs	150 lbs	300 lbs	400 lbs	600 lbs
			Outside diameter (mm)				
650	26	660	708	725	772	746	765
700	28	711	759	776	826	800	819
750	30	762	810	827	886	857	879
800	32	813	861	881	940	911	934
850	34	864	911	935	994	962	997
900	36	914	973	988	1,048	1,022	1,048
950	38	965	1,024	1,044	1,099		
1,000	40	1,016	1,075	1,095	1,149		
1,050	42	1,067	1,126	1,146	1,200		
1,100	44	1,118	1,181	1,197	1,251		
1,150	46	1,168	1,232	1,256	1,318		
1,200	48	1,219	1,283	1,307	1,369		
1,250	50	1,270	1,334	1,357	1,419		
1,300	52	1,321	1,387	1,408	1,470		
1,350	54	1,372	1,438	1,464	1,556		
1,400	56	1,422	1,496	1,514	1,594		
1,450	58	1,473	1,546	1,580	1,656		
1,500	60	1,524	1,597	1,630	1,705		

# Kammprofile gaskets dimensions (acc. to EN 1514-6 (2003))

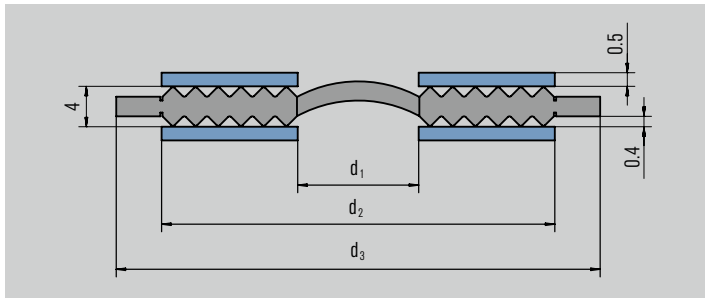

Dimensions of Kammprofile gaskets to EN 1514-6 (2003)

DN	d1 (mm)	d2 (mm)			d3 (mm)														
		PN	PN	PN	PN	PN	PN	PN	PN	PN	PN	PN	PN	PN					
		10/40	64/160	250/400	10	16	25	40	64	100	160	250	320	400					
10	22	36			46					56					67				
15	26	42			51					61					72				
20	31	47			61					-	-	-	-	-	-	-	-		
25	36	52			71					82					83	92	104		
32	46	62	66		82					-	-	-	-	-	-	-			
40	53	69	73		92					103,00					109	119	135		
50	65	81	87		107					113	119			124	134	150			
65	81	100	103		127					137	143			153	170	192			
80	95	115	121		142					148	154			170	190	207			
100	118	138	146		162		168			174	180			202	229	256			
125	142	162	178		192		194			210	217			242	274	301			
150	170	190	212		217		224			247	257			284	311	348			
175	195	215		245	247		254	265		277	287	284		316	358	402			
200	220	240	248	280	272			284	290		309	324			358	398	442		
250	270	290	300	340	327	328		340	352		364	391	388		442	488	-		
300	320	340	356	400	377	383		400	417		424	458			536	-	-		
350	375	395	415	-	437	443		457	474		486	512	-			-	-	-	
400	426	450	474	-	489	495		514	546		543	572	-			-	-	-	
450	480	506	-	-	539	555		-	571		-	-	-			-	-	-	
500	530	560	588	-	594	617		624	628		657	704	-			-	-	-	
600	630	664	700	-	695	734		731	747		764	813	-			-	-	-	
700	730	770	812	-	810	804		833	852		879	950	-			-	-	-	
800	830	876	886	-	917	911		942	974		988	-	-			-	-	-	
900	930	982	994	-	1,017	1,011		1,042	1,084		1,108	-	-			-	-	-	
1,000	1,040	1,098	1,110	-	1,124	1,128		1,154	1,194		1,220	-	-			-	-	-	
1,200	1,250	1,320	1,334	-	1,341	1,342		1,364	1,398		1,452	-	-			-	-	-	
1,400	1,440	1,522	-	-	1,548	1,542		1,578	1,618		-	-	-			-	-	-	
1,600	1,650	1,742	-	-	1,772	1,764		1,798	1,830		-	-	-			-	-	-	
1,800	1,850	1,914	-	-	1,972	1,964		2,000	-		-	-	-			-	-	-	
2,000	2,050	2,120	-	-	2,182	2,168		2,230	-		-	-	-			-	-	-	
2,200	2,250	2,328	-	-	2,384	2,378		-	-		-	-	-			-	-	-	
2,400	2,460	2,512	-	-	2,594	-		-	-		-	-	-			-	-	-	
2,600	2,670	2,728	-	-	2,794	-		-	-		-	-	-			-	-	-	
2,800	2,890	2,952	-	-	3,014	-		-	-		-	-	-			-	-	-	
3,000	3,100	3,166	-	-	3,228	-		-	-		-	-	-			-	-	-	

# Spiral wound gaskets dimensions (acc. to EN 1514-2 (2005) and ASME B16.20 (2007))

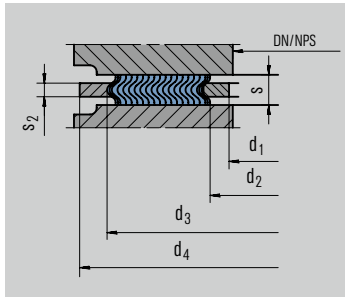

We recommend type GIa with inner and outer ring starting from the following nominal widths and nominal pressures: from PN 10 to DN 250, from PN 64 for DN 300 to DN 700, and from PN 16 for DN 800 and above.

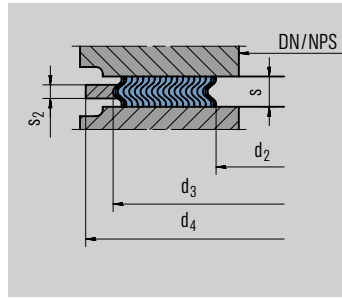

Gasket dimensions for flanges according to DIN 2513 with projection and recess (VR and VRI profile) for PN 25 to PN 100 and for flanges to DIN 2512 with tongue and groove (NF profile) for PN 25 to PN 160.

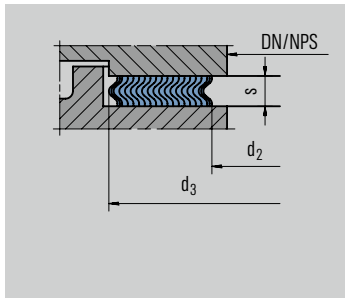

Profile VR for flanges with projection and recess. Item No. 9594-VR.

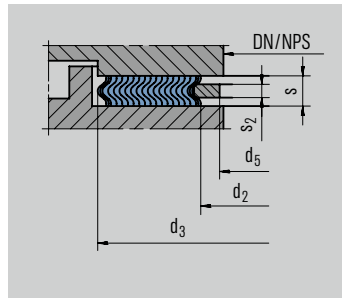

Profile VRI for flanges with projection and recess with inner ring. Item No. 9594-VRI.

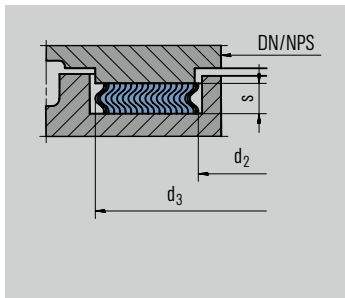

Profile NF for flanges with tongue and groove. Item No. 9594-NF.

# Spiral wound gasket color code chart (acc. to ASME B16.20 (2007))

## ASME B16.20 color code chart

### Spiral wound gasket metallic windings and non-metallic fillers

Metal	OD ring color	
304 stainless steel	Yellow	
316L stainless steel	Green	
317L stainless steel	Maroon	
321 stainless steel	Turquoise	
347 stainless steel	Blue	
Monel®	Orange	
Nickel	Red	
Titanium	Purple	
Alloy 20	Black	
Inconel® 600	Gold	
Hastelloy® B	Brown	

Metal	OD ring color	
Hastelloy® C	Beige	
Incoloy® 800	White	

Material	Stripe color	
Flexible graphite	Gray	
PTFE	White	
Ceramic	Lt. Green	
Verdicarb (mica graphite)	Pink	



### Dimensions of Spiral wound gaskets Spiraltherm to EN 1514-2 (2005)

DN (mm)	d <sub>1</sub> (mm)	d <sub>2</sub> (mm)	d <sub>3</sub> (mm)		d <sub>4</sub> (mm)									
			PN 10 – 40	PN 64 – 160	PN 10	PN 25	PN 40	PN 63	PN 100	PN 160	PN 250 <sup>1)</sup>	PN 320 <sup>1)</sup>	PN 400 <sup>1)</sup>	
10	18	24	34	34		46				56		67	67	67
15	23	29	39	39		51				61		72	72	78
20	28	34	46	–		61				–		77	77	0
25	35	41	53	53		71				82		83	92	104
32	43	49	61	–		82				87 <sub>2)</sub>		100	0	0
40	50	56	68	68		92				103		109	119	135
50	61	70	86	86		107			113	119		124	134	150
65	77	86	102	106		127			137	143		153	170	192
80	90	99	115	119		142			148	154		170	190	207
100	115	127	143	147	162	168			174	180		202	229	256
125	140	152	172	176	192	194			210	217		242	274	301
150	167	179	199	203	217	224			247	257		284	311	348
200	216	228	248	252	272	284	290		309	324		358	398	442
250	267	279	303	307	327	340	352		364	391	388	442	488	
300	318	330	354	358	377	400	417		424	458	458	538		
350	360	376	400	404	437	457	474		486	512				
400	410	422	450	456	488	514	546		543	572				
500	510	522	550	556	593	624	628		657	704				
600	610	622	650	656	695	731	747		764	813				
700	710	722	756	762	810	833	852		879	950				
800	810	830	864	870	917	942	974		988					
900	910	930	964	970	1,017	1,042	1,084		1,108					
1,000	1,010	1,030	1,074	1,080	1,124	1,154	1,194		1,220					
1,200 <sup>1)</sup>	1,210	1,230	1,280	1,290	1,341	1,364	1,398		1,452					
1,400 <sup>1)</sup>	1,420	1,450	1,510		1,548	1,578	1,618							
1,600 <sup>1)</sup>	1,630	1,660	1,720		1,772	1,798	1,830							
1,800 <sup>1)</sup>	1,830	1,860	1,920		1,972	2,000								
2,000 <sup>1)</sup>	2,020	2,050	2,120		2,182	2,230								
2,200 <sup>1)</sup>	2,230	2,260	2,330		2,384									
2,400 <sup>1)</sup>	2,430	2,480	2,530		2,594									
2,600 <sup>1)</sup>	2,630	2,660	2,730		2,794									
2,800 <sup>1)</sup>	2,830	2,860	2,930		3,014									
3,000 <sup>1)</sup>	3,030	3,060	3,130		3,228									

<sup>1)</sup> EagleBurgmann Company standard for larger sizes/pressures.

<sup>2)</sup> EagleBurgmann Company standard.

### Dimensions of Spiral wound gaskets Spiraltherm to ASME B16.20 (2007) used with ASME B 16.5 flanges

NPS (in)	d <sub>1</sub> (mm)					d <sub>2</sub> (mm)					d <sub>3</sub> (mm)		d <sub>4</sub> (mm)						
	Class (lbs)					Class (lbs)					Class (lbs)		Class (lbs)						
	150 – 300	400 – 600	900	1500	2500	150 – 300	400 – 600	900	1500	2500	150 – 600	900 – 2500	150	300	400	600	900	1500	2500
1/2	14.2	14.2	14.2	14.2	14.2	19.1	19.1	19.1	19.1	19.1	31.8	31.8	47.8	54.1	54.1	54.1	63.5	63.5	69.9
3/4	20.6	20.6	20.6	20.6	20.6	25.4	25.4	25.4	25.4	25.4	39.6	39.6	57.2	66.8	66.8	66.8	69.9	69.9	76.2
1	26.9	26.9	26.9	26.9	26.9	31.8	31.8	31.8	31.8	31.8	47.8	47.8	66.8	73.2	73.2	73.2	79.5	79.5	85.9
1 1/4	38.1	38.1	38.1	33.3	33.3	47.8	47.8	39.6	39.6	39.6	60.5	60.5	76.2	82.6	82.6	82.6	88.9	88.9	104.9
1 1/2	44.5	44.5	44.5	41.4	41.4	54.1	54.1	47.8	47.8	47.8	69.9	69.9	85.9	95.3	95.3	95.3	98.6	98.6	117.6
2	55.6	55.6	55.6	52.3	52.3	69.9	69.9	58.7	58.7	58.7	85.9	85.9	104.9	111.3	111.3	111.3	143.0	143.0	146.1
2 1/2	66.5	66.5	66.5	63.5	63.5	82.6	82.6	69.9	69.9	69.9	98.6	98.6	124.0	130.3	130.3	130.3	165.1	165.1	168.4
3	81.0	81.0	78.7	78.7	78.7	101.6	101.6	95.3	92.2	92.2	120.7	120.7	136.7	149.4	149.4	149.4	168.4	174.8	196.9
4	106.4	102.6	102.6	97.8	97.8	127.0	120.7	120.7	117.6	117.6	149.4	149.4	174.8	181.1	177.8	193.8	206.5	209.6	235.0
5	131.8	128.3	128.3	124.5	124.5	155.7	147.6	147.6	143.0	143.0	177.8	177.8	196.9	215.9	212.9	241.3	247.7	254.0	279.4
6	157.2	154.9	157.9	147.3	147.3	182.6	174.8	174.8	171.5	171.5	209.6	209.6	222.3	251.0	247.7	266.7	289.1	282.7	317.5
8	215.9	205.7	196.9	196.9	196.9	233.4	225.6	222.3	215.9	215.9	263.7	257.3	279.4	308.1	304.8	320.8	358.9	352.6	387.4
10	268.2	255.3	246.1	246.1	246.1	287.3	274.6	276.4	266.7	270.0	317.5	311.2	339.9	362.0	358.9	400.1	435.1	435.1	476.3
12	317.5	307.3	292.1	292.1	292.1	339.9	327.2	323.9	323.9	317.5	374.7	368.3	409.7	422.4	419.1	457.2	498.6	520.7	549.4
14	349.3	342.9	320.8	320.8	–	371.6	362.0	355.6	362.0	–	406.4	400.1	450.9	485.9	482.6	492.3	520.7	577.9	–
16	400.1	389.9	374.7	368.3	–	422.4	412.8	412.8	406.4	–	463.6	457.2	514.4	539.8	536.7	565.2	574.8	641.4	–
18	449.3	438.2	425.5	425.5	–	474.7	469.9	463.6	463.6	–	527.1	520.7	549.4	596.9	593.9	612.9	638.3	704.9	–
20	500.1	489.0	482.6	476.3	–	525.5	520.7	520.7	514.4	–	577.9	571.5	606.6	654.1	647.7	682.8	698.5	755.7	–
24	603.3	590.6	590.6	577.9	–	628.7	628.7	628.7	616.0	–	685.8	679.5	717.6	774.7	768.4	790.7	838.2	901.7	–

# Spiraltherm wound gaskets dimensions (acc. to ASME B16.20 (2007))

## Dimensions for Spiral wound gaskets Spiraltherm to ASME B16.20 (2007) used with ASME B16.47, series A, flanges

NPS (in)	d <sub>1</sub> (mm)					d <sub>2</sub> (mm)					d <sub>3</sub> (mm)					d <sub>4</sub> (mm)				
	Class (lbs)					Class (lbs)					Class (lbs)					Class (lbs)				
	150	300	400	600	900	150	300	400	600	900	150	300	400	600	900	150	300	400	600	900
26	654.1	654.1	660.4	647.7	660.4	673.1	685.8	685.8	685.8	685.8	704.9	736.6	736.6	736.6	736.6	774.7	835.2	831.9	866.9	882.7
28	704.9	704.9	711.2	698.5	711.2	723.9	736.6	736.6	736.6	736.6	755.7	787.4	787.4	787.4	787.4	831.9	898.7	892.3	914.4	946.2
30	755.7	755.7	755.7	755.7	768.4	774.7	793.8	793.8	793.8	793.8	806.5	844.6	844.6	844.6	844.6	882.7	952.5	946.2	971.6	1,009.7
32	806.5	806.5	812.8	812.8	812.8	825.5	850.9	850.9	850.9	850.9	860.6	901.7	901.7	901.7	901.7	939.8	1,006.6	1,003.3	1,022.4	1,073.2
34	857.3	857.3	863.6	863.6	863.6	876.3	901.7	901.7	901.7	901.7	911.4	952.5	952.5	952.5	952.5	990.6	1,057.4	1,054.1	1,073.2	1,136.7
36	908.1	908.1	917.7	917.7	920.8	927.1	955.8	955.8	955.8	958.9	968.5	1,006.6	1,006.6	1,006.6	1,009.7	1,047.8	1,117.6	1,117.6	1,130.3	1,200.2
38	958.9	952.5	952.5	952.5	1,009.7	977.9	977.9	971.6	990.6	1,035.1	1,019.3	1,016.0	1,022.4	1,041.4	1,085.9	1,111.3	1,054.1	1,073.2	1,104.9	1,200.2
40	1,009.7	1,003.3	1,000.3	1,009.7	1,060.5	1,028.7	1,022.4	1,025.7	1,047.8	1,098.6	1,070.1	1,070.1	1,076.5	1,098.6	1,149.4	1,162.1	1,114.6	1,127.3	1,155.7	1,251.0
42	1,060.5	1,054.1	1,051.1	1,066.8	1,111.3	1,079.5	1,073.2	1,076.5	1,104.9	1,149.4	1,124.0	1,120.9	1,127.3	1,155.7	1,200.2	1,219.2	1,165.4	1,178.1	1,219.2	1,301.8
44	1,111.3	1,104.9	1,104.9	1,111.3	1,155.7	1,130.3	1,130.3	1,130.3	1,162.1	1,206.5	1,178.1	1,181.1	1,181.1	1,212.9	1,257.3	1,276.4	1,219.2	1,231.9	1,270.0	1,368.6
46	1,162.1	1,152.7	1,168.4	1,162.1	1,219.2	1,181.1	1,178.1	1,193.8	1,212.9	1,270.0	1,228.9	1,228.9	1,244.6	1,263.7	1,320.8	1,327.2	1,273.3	1,289.1	1,327.2	1,435.1
48	1,212.9	1,209.8	1,206.5	1,219.2	1,270.0	1,231.9	1,235.2	1,244.6	1,270.0	1,320.8	1,279.7	1,286.0	1,295.4	1,320.8	1,371.6	1,384.3	1,324.1	1,346.2	1,390.7	1,485.9
50	1,263.7	1,244.6	1,257.3	1,270.0	-	1,282.7	1,295.4	1,295.4	1,320.8	-	1,333.5	1,346.2	1,346.2	1,371.6	-	1,435.1	1,378.0	1,403.4	1,447.8	-
52	1,314.5	1,320.8	1,308.1	1,320.8	-	1,333.5	1,346.2	1,346.2	1,371.6	-	1,384.3	1,397.0	1,397.0	1,422.4	-	1,492.3	1,428.8	1,454.2	1,498.6	-
54	1,358.9	1,352.6	1,352.6	1,378.0	-	1,384.3	1,403.4	1,403.4	1,428.8	-	1,435.1	1,454.2	1,454.2	1,479.6	-	1,549.4	1,492.3	1,517.7	1,555.8	-
56	1,409.7	1,403.4	1,403.4	1,428.8	-	1,435.1	1,454.2	1,454.2	1,479.6	-	1,485.9	1,505.0	1,505.0	1,530.4	-	1,606.6	1,543.1	1,568.5	1,612.9	-
58	1,460.5	1,447.8	1,454.2	1,473.2	-	1,485.9	1,511.3	1,505.0	1,536.7	-	1,536.7	1,562.1	1,555.8	1,587.5	-	1,663.7	1,593.9	1,619.3	1,663.7	-
60	1,511.3	1,524.0	1,517.7	1,530.4	-	1,535.7	1,562.1	1,568.5	1,593.9	-	1,587.5	1,612.9	1,619.3	1,644.7	-	1,714.5	1,644.7	1,682.8	1,733.6	-

## Dimension for Spiral wound gaskets Spiraltherm to ASME B16.20 (2007) used with ASME B16.47, series B, flanges

NPS (in)	d <sub>1</sub> (mm)					d <sub>2</sub> (mm)					d <sub>3</sub> (mm)					d <sub>4</sub> (mm)				
	Class (lbs)					Class (lbs)					Class (lbs)					Class (lbs)				
	150	300	400	600	900	150	300	400	600	900	150	300	400	600	900	150	300	400	600	900
26	654.1	654.1	654.1	644.7	666.8	673.1	673.1	666.8	663.7	692.2	698.5	711.2	698.5	714.5	749.3	725.4	771.7	746.3	765.3	838.2
28	704.9	704.9	701.8	685.8	717.6	723.9	723.9	714.5	704.9	743.0	749.3	762.0	749.3	755.7	800.1	776.2	825.5	800.1	819.2	901.7
30	755.7	755.7	752.6	752.6	781.1	774.7	774.7	765.3	778.0	806.5	800.1	812.8	806.5	828.8	857.3	827.0	886.0	857.3	879.6	958.9
32	806.5	806.5	800.1	793.8	838.2	825.5	825.5	812.8	831.9	863.6	850.9	863.6	860.6	882.7	914.4	881.1	939.8	911.4	933.5	1,016.0
34	857.3	857.3	850.9	850.9	895.4	876.3	876.3	866.9	889.0	920.8	908.1	914.4	911.4	939.8	971.6	935.0	993.9	962.2	997.0	1,073.2
36	908.1	908.1	898.7	901.7	920.8	927.1	927.1	917.7	939.8	946.2	958.9	965.2	965.2	990.6	997.0	987.6	1,047.8	1,022.4	1,047.8	1,124.0
38	958.9	971.6	952.5	952.5	1,009.7	974.9	1,009.7	971.6	990.6	1,035.1	1,009.7	1,047.8	1,022.4	1,041.4	1,085.9	1,044.7	1,098.6	1,073.2	1,104.9	1,200.2
40	1,009.7	1,022.4	1,000.3	1,009.7	1,060.5	1,022.4	1,060.5	1,025.7	1,047.8	1,098.6	1,063.8	1,098.6	1,076.5	1,098.6	1,149.4	1,095.5	1,149.4	1,127.3	1,155.7	1,251.0
42	1,060.5	1,085.9	1,051.1	1,066.8	1,111.3	1,079.5	1,111.3	1,076.5	1,104.9	1,149.4	1,114.6	1,149.4	1,127.3	1,155.7	1,200.2	1,146.3	1,200.2	1,178.1	1,219.2	1,301.8
44	1,111.3	1,124.0	1,104.9	1,111.3	1,155.7	1,124.0	1,162.1	1,130.3	1,162.1	1,206.5	1,165.4	1,200.2	1,181.1	1,212.9	1,257.3	1,197.1	1,251.0	1,231.9	1,270.0	1,368.6
46	1,162.1	1,178.1	1,168.4	1,162.1	1,219.2	1,181.1	1,216.2	1,193.8	1,212.9	1,270.0	1,224.0	1,254.3	1,244.6	1,263.7	1,320.8	1,255.7	1,317.8	1,289.1	1,327.2	1,435.1
48	1,212.9	1,231.9	1,206.5	1,219.2	1,270.0	1,231.9	1,263.7	1,244.6	1,270.0	1,320.8	1,270.0	1,311.4	1,295.4	1,320.8	1,371.6	1,306.6	1,368.6	1,346.2	1,390.7	1,485.9
50	1,263.7	1,267.0	1,257.3	1,270.0	-	1,282.7	1,317.8	1,295.4	1,320.8	-	1,325.6	1,355.9	1,346.2	1,371.6	-	1,357.4	1,419.4	1,403.4	1,447.8	-
52	1,314.5	1,317.8	1,308.1	1,320.8	-	1,335.5	1,368.6	1,346.2	1,371.6	-	1,376.4	1,406.7	1,397.0	1,422.4	-	1,408.2	1,470.2	1,454.2	1,498.6	-
54	1,365.3	1,365.3	1,352.6	1,378.0	-	1,384.3	1,403.4	1,403.4	1,428.8	-	1,422.4	1,454.2	1,454.2	1,479.6	-	1,463.8	1,530.4	1,517.7	1,555.8	-
56	1,422.4	1,428.8	1,403.4	1,428.8	-	1,444.8	1,479.6	1,454.2	1,479.6	-	1,478.0	1,524.0	1,505.0	1,530.4	-	1,514.6	1,593.9	1,568.5	1,612.9	-
58	1,478.0	1,484.4	1,454.2	1,473.2	-	1,500.1	1,535.2	1,505.0	1,536.7	-	1,528.8	1,573.3	1,555.8	1,587.5	-	1,579.6	1,655.8	1,619.3	1,663.7	-
60	1,535.2	1,557.3	1,517.7	1,530.4	-	1,557.3	1,589.0	1,568.5	1,593.9	-	1,586.0	1,630.4	1,619.3	1,644.7	-	1,630.4	1,706.6	1,682.8	1,733.6	-

# Jacketed gaskets dimensions (acc. to ASME B16.20 (2007))

## Dimensions of Jacketed gaskets to ASME B16.20 (2007) used with ASME B16.5 flanges

DN (mm)	NPS (in)	Gasket inside diameter (mm)	Gasket outside diameter by class						
			150	300	400	600	900	1500	2500
15	1/2	22.4	44.5	50.8	50.8	50.8	60.5	60.5	66.8
20	3/4	28.7	54.1	63.5	63.5	63.5	66.8	66.8	73.2
25	1	38.1	63.5	69.9	69.9	69.9	76.2	76.2	82.6
32	1 1/4	47.8	73.2	79.5	79.5	79.5	85.9	85.9	101.6
40	1 1/2	54.1	82.6	92.2	92.2	92.2	95.3	95.3	114.3
50	2	73.2	101.6	108.0	108.0	108.0	139.7	139.7	143.0
65	2 1/2	85.9	120.7	127.0	127.0	127.0	162.0	162.0	165.1
80	3	108.0	133.4	146.1	146.1	146.1	165.1	171.5	193.8
100	4	131.8	171.5	177.8	174.8	190.5	203.2	206.5	231.9
125	5	152.4	193.8	212.9	209.6	238.3	244.6	251.0	276.4
150	6	190.5	219.2	247.7	244.6	263.7	285.8	279.4	314.5
200	8	238.2	276.4	304.8	301.8	317.5	355.6	349.3	384.3
250	10	285.8	336.6	358.9	355.6	397.0	431.8	431.8	473.2
300	12	342.9	406.4	419.1	416.1	454.2	495.3	517.7	546.1
350	14	374.7	447.8	482.6	479.6	489.0	517.7	574.8	-
400	16	425.5	511.3	536.7	533.4	562.1	571.5	638.3	-
450	18	489.0	546.1	593.9	590.6	609.6	635.0	701.8	-
500	20	533.4	603.3	651.0	644.7	679.5	695.5	752.6	-
600	24	641.4	714.5	771.7	765.3	787.4	835.2	898.7	-

## Dimensions of Jacketed Gaskets to ASME 16.20 (2007) for ASME B16.47, series A, flanges

DN (mm)	NPS (in)	Inside diameter (mm)	Outer diameter by class				
			150	300	400	600	900
650	26	673.1	771.7	831.9	828.8	863.6	879.6
700	28	723.9	828.8	895.4	889.0	911.4	943.1
750	30	774.7	879.6	949.5	943.1	968.5	1,006.6
800	32	825.5	936.8	1,003.3	1,000.3	1,019.3	1,070.1
850	34	876.3	987.6	1,054.1	1,051.1	1,070.1	1,133.6
900	36	927.1	1,044.7	1,114.6	1,114.6	1,127.3	1,197.1
950	38	977.9	1,108.2	1,051.1	1,070.1	1,101.9	1,197.1
1,000	40	1,028.7	1,159.0	1,111.3	1,124.0	1,152.7	1,247.9
1,050	42	1,079.5	1,216.2	1,162.1	1,174.8	1,216.2	1,298.7
1,100	44	1,130.3	1,273.3	1,216.2	1,228.9	1,267.0	1,365.3
1,150	46	1,181.1	1,324.1	1,270.0	1,286.0	1,324.1	1,432.1
1,200	48	1,231.9	1,381.3	1,320.8	1,343.2	1,387.6	1,482.9
1,250	50	1,282.7	1,432.1	1,374.9	1,400.3	1,444.8	-
1,300	52	1,333.5	1,489.2	1,425.7	1,451.1	1,495.6	-
1,350	54	1,384.3	1,546.4	1,489.2	1,514.6	1,552.7	-
1,400	56	1,435.1	1,603.5	1,540.0	1,565.4	1,603.5	-
1,450	58	1,485.9	1,660.7	1,590.8	1,616.2	1,660.7	-
1,500	60	1,536.7	1,711.5	1,641.6	1,679.7	1,730.5	-

## Dimensions of Jacketed gaskets to ASME B 16.20 for ASME B16.47, series B, flanges

DN (mm)	NPS (in)	Inner diameter	Outer diameter				
			150	300	400	600	900
650	26	673.1	722.4	768.4	743.0	762.0	835.2
700	28	723.9	773.2	822.5	797.1	816.1	898.7
750	30	774.7	824.0	882.7	854.2	876.3	955.8
800	32	825.5	877.8	936.8	908.1	930.4	1,013.0
850	34	876.3	931.9	990.6	958.9	993.9	1,070.1
900	36	927.1	984.3	1,044.7	1,019.3	1,044.7	1,120.9
950	38	977.9	1,041.4	1,095.5	1,070.1	1,101.9	1,197.1
1,000	40	1,028.7	1,092.2	1,146.3	1,124.0	1,152.7	1,247.9
1,050	42	1,079.5	1,143.0	1,197.1	1,174.8	1,216.2	1,298.7
1,100	44	1,130.3	1,193.8	1,247.9	1,228.9	1,267.0	1,365.3
1,150	46	1,181.1	1,252.4	1,314.5	1,286.0	1,324.1	1,432.1
1,200	48	1,231.9	1,303.3	1,365.3	1,343.2	1,387.6	1,482.9
1,250	50	1,282.7	1,354.1	1,416.1	1,400.3	1,444.8	-
1,300	52	1,333.5	1,404.9	1,466.9	1,451.1	1,495.6	-
1,350	54	1,384.3	1,460.5	1,527.3	1,514.6	1,552.7	-
1,400	56	1,435.1	1,511.3	1,590.8	1,565.4	1,603.5	-
1,450	58	1,485.9	1,576.3	1,652.5	1,616.2	1,660.7	-
1,500	60	1,536.7	1,627.1	1,703.3	1,679.7	1,730.5	-

# Ring type joints dimensions (acc. to ASME B16.20 (2007) Part 1)

## Dimensions of Ring joints Type R Buralloy to ASME B16.20 (2007) part 1

Ring number	Average pitch diameter P		Width A		Height			
					Oval, B		Octagonal, H	
	(mm)	(in)	(mm)	(in)	(mm)	(in)	(mm)	(in)
R-11	34.14	1.344	6.35	0.250	11.20	0.44	9.70	0.38
R-12	39.70	1.563	7.95	0.313	14.20	0.56	12.70	0.50
R-13	42.88	1.688	7.95	0.313	14.20	0.56	12.70	0.50
R-14	44.45	1.750	7.95	0.313	14.20	0.56	12.70	0.50
R-15	47.63	1.875	7.95	0.313	14.20	0.56	12.70	0.50
R-16	50.80	2.000	7.95	0.313	14.20	0.56	12.70	0.50
R-17	57.15	2.250	7.95	0.313	14.20	0.56	12.70	0.50
R-18	60.33	2.375	7.95	0.313	14.20	0.56	12.70	0.50
R-19	65.10	2.563	7.95	0.313	14.20	0.56	12.70	0.50
R-20	68.28	2.688	7.95	0.313	14.20	0.56	12.70	0.50
R-21	72.24	2.844	11.13	0.438	17.50	0.69	16.00	0.63
R-22	82.55	3.250	7.95	0.313	14.20	0.56	12.70	0.50
R-23	82.55	3.250	11.13	0.313	17.50	0.69	16.00	0.63
R-24	95.25	3.750	11.13	0.438	17.50	0.69	16.00	0.63
R-25	101.60	4.000	7.95	0.313	14.20	0.56	12.70	0.50
R-26	101.60	4.000	11.13	0.438	17.50	0.69	16.00	0.63
R-27	107.95	4.250	11.13	0.438	17.50	0.69	16.00	0.63
R-28	111.13	4.375	12.70	0.500	19.10	0.75	17.50	0.69
R-29	114.30	4.500	7.95	0.313	14.20	0.56	12.70	0.50
R-30	117.48	4.625	11.13	0.438	17.50	0.69	16.00	0.63
R-31	123.83	4.875	11.13	0.438	17.50	0.69	16.00	0.63
R-32	127.00	5.000	12.70	0.500	19.10	0.75	17.50	0.69
R-33	131.78	5.188	7.95	0.313	14.20	0.56	12.70	0.50
R-34	131.78	5.188	11.13	0.438	17.50	0.69	16.00	0.63
R-35	136.53	5.375	11.13	0.438	17.50	0.69	16.00	0.63
R-36	149.23	5.875	7.95	0.313	14.20	0.56	12.70	0.50
R-37	149.23	5.875	11.13	0.438	17.50	0.69	16.00	0.63
R-38	157.18	6.188	15.88	0.625	22.40	0.88	20.60	0.81
R-39	161.93	6.375	11.13	0.438	17.50	0.69	16.00	0.63
R-40	171.45	6.750	7.95	0.313	14.20	0.56	12.70	0.50
R-41	180.98	7.125	11.13	0.438	17.50	0.69	16.00	0.63
R-42	190.50	7.500	19.05	0.750	25.40	1.00	23.90	0.94
R-43	193.68	7.625	7.95	0.313	14.20	0.56	12.70	0.50
R-44	193.68	7.625	11.13	0.438	17.50	0.69	16.00	0.63
R-45	211.15	8.313	11.13	0.438	17.50	0.69	16.00	0.63
R-46	211.15	8.313	12.70	0.500	19.10	0.75	17.50	0.69
R-47	228.60	9.000	19.05	0.750	25.40	1.00	23.90	0.94
R-48	247.65	9.750	7.95	0.313	14.20	0.56	12.70	0.50
R-49	269.88	10.625	11.13	0.438	17.50	0.69	16.00	0.63
R-50	269.88	10.625	15.88	0.625	22.40	0.88	20.60	0.81
R-51	279.40	11.000	22.23	0.875	28.70	1.13	27.00	1.06
R-52	304.80	12.000	7.95	0.313	14.20	0.56	12.70	0.50
R-53	323.85	12.750	11.13	0.438	17.50	0.69	16.00	0.63
R-54	323.85	12.750	15.88	0.625	22.40	0.88	20.60	0.81
R-55	342.90	13.500	28.58	1.125	36.60	1.44	34.90	1.38
R-56	381.00	15.000	7.95	0.313	14.20	0.56	12.70	0.50
R-57	381.00	15.000	11.13	0.438	17.50	0.69	16.00	0.63
R-58	381.00	15.000	22.23	0.875	28.70	1.13	27.00	1.06
R-59	396.88	15.625	7.95	0.313	14.20	0.56	12.70	0.50
R-60	406.40	16.000	31.75	1.250	39.70	1.56	38.10	1.50
R-61	419.10	16.500	11.13	0.438	17.50	0.69	16.00	0.63
R-62	419.10	16.500	15.88	0.625	22.20	0.88	20.60	0.81
R-63	419.10	16.500	25.40	1.000	33.30	1.31	31.80	1.25
R-64	454.03	17.875	7.95	0.313	14.20	0.56	12.70	0.50
R-65	469.90	18.500	11.13	0.438	17.50	0.69	16.00	0.63
R-66	469.90	18.500	15.88	0.625	22.20	0.88	20.60	0.81
R-67	469.90	18.500	28.58	1.125	36.60	1.44	35.10	1.38
R-68	517.53	20.375	7.95	0.313	14.20	0.56	12.70	0.50
R-69	533.40	21.000	11.13	0.438	17.50	0.69	16.00	0.63
R-70	533.40	21.000	19.05	0.750	25.40	1.00	23.90	0.94
R-71	533.40	21.000	28.58	1.125	36.60	1.44	34.90	1.38
R-72	558.80	22.000	7.95	0.313	14.20	0.56	12.70	0.50
R-73	584.20	23.000	12.70	0.500	19.10	0.75	17.50	0.69
R-74	584.20	23.000	19.05	0.750	25.40	1.00	23.90	0.94
R-75	584.20	23.000	31.75	1.250	39.60	1.56	38.10	1.50
R-76	673.10	26.500	7.95	0.313	14.20	0.56	12.70	0.50
R-77	692.15	27.250	15.88	0.625	22.40	0.88	20.60	0.81

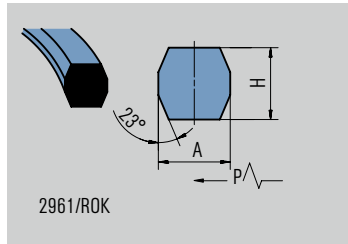
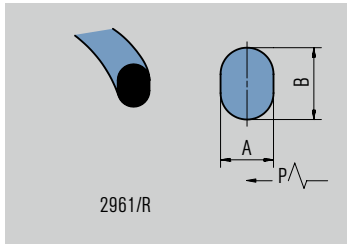

**Dimensions of Ring joints Type R Buralloy to ASME B16.20 (2007) part 2**

Ring number	Average pitch diameter P		Width A		Height			
					Oval, B		Octagonal, H	
	(mm)	(in)	(mm)	(in)	(mm)	(in)	(mm)	(in)
R-78	692.15	27.250	25.40	1.000	33.30	1.31	31.80	1.25
R-79	692.15	27.250	34.93	1.375	44.50	1.75	41.30	1.63
R-80	615.95	24.250	7.95	0.313	-	-	12.70	0.50
R-81	635.00	25.000	14.30	0.563	-	-	19.10	0.75
R-82	57.15	2.250	11.13	0.438	-	-	16.00	0.63
R-84	63.50	2.500	11.13	0.438	-	-	16.00	0.63
R-85	79.38	3.125	12.70	0.500	-	-	17.50	0.69
R-86	90.50	3.563	15.88	0.625	-	-	20.60	0.81
R-87	100.03	3.938	15.88	0.625	-	-	20.60	0.80
R-88	122.83	4.875	19.05	0.750	-	-	23.90	0.94
R-89	114.30	4.500	19.05	0.750	-	-	23.90	0.94
R-90	155.58	6.125	22.23	0.875	-	-	26.90	1.06
R-91	260.35	10.250	31.75	1.250	-	-	38.10	1.50
R-92	228.60	9.000	11.13	0.438	17.50	0.69	16.00	0.63
R-93	749.30	29.500	19.05	0.750	-	-	23.90	0.94
R-94	800.10	31.500	19.05	0.750	-	-	23.09	0.94
R-95	857.25	33.750	19.05	0.750	-	-	23.09	0.94
R-96	914.40	36.000	22.23	0.875	-	-	26.90	1.06
R-97	965.20	38.000	22.23	0.875	-	-	26.90	1.06
R-98	1,022.35	40.250	22.23	0.875	-	-	26.90	1.06
R-99	234.95	9.250	11.13	0.438	-	-	16.00	0.63
R-100	749.30	29.500	28.58	1.125	-	-	35.10	1.38
R-101	800.10	31.500	31.75	1.250	-	-	38.10	1.50
R-102	857.25	33.750	31.75	1.250	-	-	38.10	1.50
R-103	914.40	36.000	31.75	1.250	-	-	38.10	1.50
R-104	965.20	38.000	34.93	1.375	-	-	41.40	1.63
R-105	1,022.35	40.250	34.93	1.375	-	-	41.40	1.63

# Ring type joints dimensions (acc. to ASME B16.20 (2007))

## Dimensions of Ring joints Type RX Buralloy to ASME B16.20 (2007)

Ring number	Outside diameter OD		Width		Height	
			A		H	
	(mm)	(in)	(mm)	(in)	(mm)	(in)
RX-20	76.20	3.000	8.74	0.344	19.05	0.750
RX-23	93.27	3.672	11.91	0.469	25.40	1.000
RX-24	105.97	4.172	11.91	0.469	25.40	1.000
RX-25	109.55	4.313	8.74	0.344	19.05	0.750
RX-26	111.91	4.406	11.91	0.469	25.40	1.000
RX-27	118.26	4.656	11.91	0.469	25.40	1.000
RX-31	134.54	5.297	11.91	0.469	25.40	1.000
RX-35	147.24	5.797	11.91	0.469	25.40	1.000
RX-37	159.94	6.297	11.91	0.469	25.40	1.000
RX-39	172.64	6.797	11.91	0.469	25.40	1.000
RX-41	191.69	7.547	11.91	0.469	25.40	1.000
RX-44	204.39	8.047	11.91	0.469	25.40	1.000
RX-45	221.84	8.734	11.91	0.469	25.40	1.000
RX-46	222.25	8.750	13.49	0.531	28.58	1.125
RX-47	245.26	9.656	19.84	0.781	41.28	1.625
RX-49	280.59	11.047	11.91	0.469	25.40	1.000
RX-50	283.36	11.156	16.66	0.656	31.75	1.250
RX-53	334.57	13.172	11.91	0.469	25.40	1.000
RX-54	337.34	13.281	16.66	0.656	31.75	1.250
RX-57	391.72	15.422	11.91	0.469	25.40	1.000
RX-63	441.73	17.391	27.00	1.063	50.80	2.000
RX-65	480.62	18.922	11.91	0.469	25.40	1.000
RX-66	457.99	18.031	16.66	0.656	31.75	1.250
RX-69	544.12	21.422	11.91	0.469	25.40	1.000
RX-70	550.06	21.656	19.84	0.781	41.28	1.625
RX-73	596.11	23.469	13.49	0.531	31.75	1.250
RX-74	600.86	23.656	19.84	0.781	41.28	1.625
RX-82	67.87	2.672	11.91	0.469	25.40	1.000
RX-84	74.22	2.922	11.91	0.469	25.40	1.000
RX-85	90.09	3.547	13.49	0.531	25.40	1.000
RX-86	103.58	4.078	15.09	0.594	28.58	1.125
RX-87	113.11	4.453	15.09	0.594	28.58	1.125
RX-88	139.29	5.484	17.48	0.688	31.75	1.250
RX-89	129.77	5.109	18.26	0.719	31.75	1.250
RX-90	174.63	6.875	19.84	0.781	44.45	1.750
RX-91	286.94	11.297	30.18	1.188	45.24	1.781
RX-99	245.67	9.672	11.91	0.469	25.40	1.000
RX-201	51.46	2.026	5.74	0.226	11.30	0.445
RX-205	62.31	2.453	5.56	0.219	11.10	0.437
RX-210	97.64	3.844	9.53	0.375	19.05	0.750
RX-215	140.89	5.547	11.91	0.469	25.40	1.000

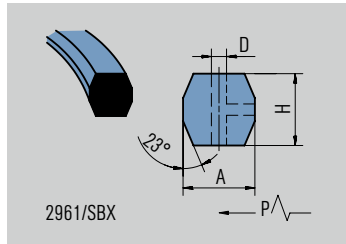
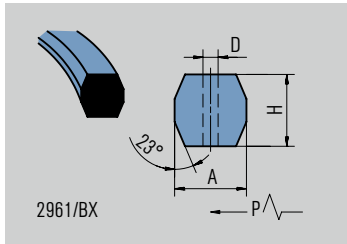

**Dimensions of Ring joints Type BX Buralloy to ASME B16.20 (2007)**

Ring number	Nominal size		Outside diameter OD		Width A		Height H		Hole size D	
	(mm)	(in)	(mm)	(in)	(mm)	(in)	(mm)	(in)	(mm)	(in)
BX-150	43	1 11/16	72.19	2.842	9.30	0.366	9.30	0.366	1.5	0.06
BX-151	46	1 13/16	76.40	3.008	9.63	0.379	9.63	0.379	1.5	0.06
BX-152	52	2 1/16	84.68	3.334	10.24	0.403	10.24	0.403	1.5	0.06
BX-153	65	2 9/16	100.94	3.974	11.38	0.448	11.38	0.448	1.5	0.06
BX-154	78	3 1/16	116.84	4.600	12.40	0.488	12.40	0.488	1.5	0.06
BX-155	103	4 1/16	147.96	5.825	14.22	0.560	14.22	0.560	1.5	0.06
BX-156	179	7 1/16	237.92	9.367	18.62	0.733	18.62	0.733	3.0	0.12
BX-157	229	9	294.46	11.593	20.98	0.826	20.98	0.826	3.0	0.12
BX-158	279	11	352.04	13.860	23.14	0.911	23.14	0.911	3.0	0.12
BX-159	346	13 5/8	426.72	16.800	25.70	1.012	25.70	1.012	3.0	0.12
BX-160	346	13 5/8	402.59	15.850	13.74	0.541	23.83	0.938	3.0	0.12
BX-161	422	16 5/8	491.41	19.347	16.21	0.638	28.07	1.105	3.0	0.12
BX-162	422	16 5/8	475.49	18.720	14.22	0.560	14.22	0.560	1.5	0.06
BX-163	476	18 3/4	556.16	21.896	17.37	0.684	30.10	1.185	3.0	0.12
BX-164	476	18 3/4	570.56	22.463	24.59	0.968	30.10	1.185	3.0	0.12
BX-165	540	21 1/4	624.71	24.595	18.49	0.728	32.03	1.261	3.0	0.12
BX-166	540	21 1/4	640.03	25.198	26.14	1.029	32.03	1.261	3.0	0.12
BX-167	680	26 3/4	759.36	29.896	13.11	0.516	35.86	1.412	1.5	0.06
BX-168	680	26 3/4	765.25	30.128	16.05	0.632	35.86	1.412	1.5	0.06
BX-169	130	5 1/8	173.51	6.831	12.93	0.509	15.85	0.624	1.5	0.06
BX-170	168	6 5/8	218.03	8.584	14.22	0.560	14.22	0.560	1.5	0.06
BX-171	218	8 9/16	267.44	10.529	14.22	0.560	14.22	0.560	1.5	0.06
BX-172	283	11 5/32	333.07	13.113	14.22	0.560	14.22	0.560	1.5	0.06
BX-303	762	30	852.75	33.573	16.97	0.668	37.95	1.494	1.5	0.06

# TotalSealCare service

## TotalSealCare – The modular seal service from EagleBurgmann



Are you planning an overhaul of your plant? Perhaps you have a deadline for an upgrade or conversion of all valves to meet fugitive emission regulations, for example. You need more engineers and qualified technical staff? This is where EagleBurgmann can help you – with our mobile on-site sealing service. You describe the scope of work and EagleBurgmann will organize a complete seal workshop to be delivered to site with all the required tools, men and materials. All managed by an experienced EagleBurgmann site engineer. To make sure that everything goes according to your timetable.

### The benefits to you are

- Our knowledge and experience in all matters to do with seals
- Planning and keeping to budget
- No extra storage required
- Quickest seal supply
- No additional staff of your own required
- Sealing solutions installed are the latest technology and in compliance with the relevant statutory provisions
- Site independent due to own mobile service workshop

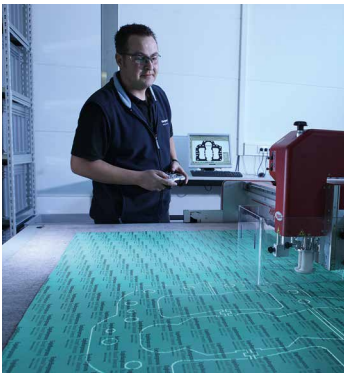

### Gasket cutting service

EagleBurgmann has strategically located gasket cutting centers around the world offering 24 hour turnaround times for custom-made gaskets. The state-of-the-art CNC machines offer flexibility and low cost in either producing a single gasket or small to medium size batch quantities.



### The benefits to you are

- No tooling costs
- Almost any gasket material can be cut into the most intricate shape
- Reduce your spares stock since delivery can be made in hours (by prior arrangement)
- Reduce downtime caused by non-availability of critical gasket components

## GasketXpress production for maintenance demands

In key centers around the world, the EagleBurgmann GasketXpress gasket units manufacture gaskets on a made-to-order basis in a matter of hours.

### Cut gaskets

Using state-of-the-art cutting technology, EagleBurgmann can ensure that even the most complex shape is produced accurately, time after time. Gaskets can be produced from simple drawings or downloaded CAD (DXF) files. All standard gasket sheet materials are available.

### Metallic gaskets

Spiral wound gaskets, Kammprofiles and RTJs are available for emergency and breakdown requirements within hours from the EagleBurgmann Gasket Xpress gasket production units.

The latest production techniques and equipment allow flexible and fast manufacturing of metallic and semi-metallic gaskets in standard metals and filler materials. A range of exotic alloys is also stocked for severe and critical applications.

# Compression packings

A cost-effective and reliable method for sealing pump shafts, valve spindles and rotating shafts in process equipment. Manufactured from a range of material combinations – traditional and innovative – using state-of-the-art production techniques. Supplied in boxed lengths or pre-cut rings. Approvals/certification includes BAM, DVGW, FDA, API, ISO, TA-Luft. Fire safe, low leakage and nuclear grades are available with full documentation and certification.

## Rotatherm graphite rings

An accepted industry standard for valves and pumps in high-pressure and high-temperature service. Manufactured as molded rings (with and without steel reinforcement) or special seals. Suits all industry applications including the power and nuclear industries. Approvals/certification includes: BAM, DVGW, API, ISO, TA-Luft.



## BuraTAL fugitive emission products



A comprehensive range of low leakage packing sets manufactured in graphite or our unique non-woven materials. All current fugitive emission standards are met with outstanding performance, low friction, ease of installation and a long service life. Approvals/certification includes: API 622, ISO 15848, TA-Luft.

## Burajet injectable packings

The Burajet injectable packing system offers a wide range of injectable compounds for pumps, valves and process equipment. An ideal product for the mining and paper & pulp industries. Approvals/Certification includes: FDA.



## Buraglas glass packings



Manufactured from non-ceramic materials and fibers, BuraGlas packings are suitable for sealing of vessels, coal mills, industrial furnaces, oven doors, hatches and covers. Produced in lengths in sizes up to 150 mm section. Approvals/Certification: Hydrolytische Klasse 1, DIN 12111.

## Packing cartridges

Packing cartridges combine quick and easy installation with robust simple construction to provide minimum downtime and maximum reliability. Manufactured to individual requirements to fit into DIN/ASME stand-ard equipment, e.g. agitators. Cartridges can be supplied with live-loading and additional bellows containment for maximum environmental safety.





# Additional EagleBurgmann product lines

## Mechanical seals for pumps

EagleBurgmann offers a complete range of liquid and gas-lubricated pump shaft seals including standard and engineered seals in single and multi-seal versions. We also offer a complete range of solutions for all API 682 categories and arrangements. The portfolio includes a broad selection of material and surface technologies such as DiamondFaces coatings.



## Carbon floating ring seals

Carbon floating ring seals are supplied as maintenance-free compact labyrinth cartridge seals with low leakage. The floating self-adjusting sealing rings provide radial sealing on the shaft with a very small gap. The seal requires no additional lubrication, and it is designed for dry running. Besides pure gas, carbon floating ring seals are also suitable for Atex applications, toxic media, media containing solids, flue gas, dust, powder, vapor, liquid mist, oil mist and penetrating oil.



## Mechanical seals for agitators



Sealing solutions for normal and sterile applications. The design and selection of materials ensure that the seals are rugged enough to deliver outstanding cost and engineering performance in everyday applications.

## Expansion joints



Flexible expansion joints in pipes and duct systems neutralize the effects of pressure and temperature fluctuation, vibration and misalignment at the joint. They must also be leakproof and resistant to media. Customized expansion joints made of fabric, metal or rubber are the solution of choice.

## Mechanical seals for compressors

A complete range of products for process gas compressors from a single source. Single, double and tandem versions and tandem seals with intermedia labyrinths. Rugged, non-wearing, non-contact seals designed to deliver outstanding performance and long service life.



## Special products

For particular applications, innovative, customized solutions are the only answer. The supplier must have a wealth of in-depth expertise, many years of experience and above all the willingness and ability to translate ideas into solutions that work in practical application.



## Magnetic couplings



Uncompromising sealing technology for very demanding applications. Hermetically sealed magnetic couplings guarantee leakage-free and maintenance-free pumping and mixing. The media remains within closed system circulation loops.

## Seal supply systems

Depending on the design, application and mode of operation, supply systems are needed to flush, cool and pressurize mechanical seals and magnetic couplings and provide leakage compensation. EagleBurgmann supplies a complete range of solutions from a single source including design, production, commissioning and service. The portfolio includes a complete line of API compliant supply systems.



Argentina · Australia · Austria · Belarus · Belgium · Bulgaria · Brazil · Canada · Chile · China · Colombia · Cyprus · Czech Republic · Denmark · Ecuador · Egypt · Estonia  
Finland · France · Germany · Great Britain · Greece · Hungary · India · Indonesia · Iraq · Israel · Italy · Japan · Jordan · Kazakhstan · Korea · Kuwait · Latvia · Libya · Lithuania  
Malaysia · Mauritius · Mexico · Morocco · Myanmar · Netherlands · New Zealand · Nigeria · Norway · Oman · Pakistan · Paraguay · Peru · Philippines · Poland · Qatar  
Romania · Russia · Saudi Arabia · Singapore · Slovenia · Slovak Republic · South Africa · Spain · Sweden · Switzerland · Syria · Taiwan · Thailand · Trinidad and Tobago · Tunisia  
Turkey · Turkmenistan · Ukraine · United Arab Emirates · Uruguay · USA · Uzbekistan · Venezuela · Vietnam · [www.eagleburgmann.com/world](http://www.eagleburgmann.com/world)



SSSE / E3 / 3.000 / 05.15 / 7.41 © EagleBurgmann Group Marketing, Germany

EagleBurgmann is one of the internationally leading companies for industrial sealing technology. Our products are used everywhere where safety and reliability are important: in the oil and gas industry, refining technology, the petrochemical, chemical and pharmaceutical industries, food processing, power, water, mining, pulp & paper, aerospace and many other spheres. Every day, more than 6,000 employees contribute their ideas, solutions and commitment towards ensuring that customers all over the world can rely on our seals. Our modular TotalSealCare service underlines our strong customer orientation and offers tailor-made services for every application.

[eagleburgmann.com](http://eagleburgmann.com)

[info@eagleburgmann.com](mailto:info@eagleburgmann.com)

**EagleBurgmann®**

Rely on excellence