

Mechanical seal technology and selection

Technical information



Seal selection by media





Content and other brochures

Technical information

Index	5
Media tables	Inside back cover

Mechanical seal selection by media

Index	23
Short legend	Fold-out page at back cover

Additional information

TotalSealCare	Outside back cover
Company profile	2
Additional product lines	50

EagleBurgmann – Your System Supplier

Separately available brochures offer information about additional product lines as well as notes on the technology and selection of mechanical seals.

All products can be retrieved interactively from eagleburgmann.com. Among others, you will find current data sheets in PDF format available for download here.

Mechanical seals, Magnetic couplings

Catalog 146 pages (Code: DMS_MSE)

The complete range of seals from EagleBurgmann:

Pump seals, agitator seals, compressor seals, and magnetic couplings.

Important note

All the technical specifications are based on extensive tests and our many years of experience. However, the diversity of possible applications means that they can serve as guide values only.

It should be noted that the extremal values of each operating parameter cannot be applied at the same time because of their interaction. Furthermore, the operating range of each specific product depends on the respective shaft diameter, materials used, mode of operation and on the medium to be sealed.

A guarantee can only be given in the individual case if the exact conditions of application are known and these are confirmed in a special agreement. When critical conditions of operation are involved, we recommend consulting with our specialist engineers.

Subject to change.

Seal supply systems

Brochure 84 Pages (Code: DMS_SSE)

The entire product portfolio of systems and components for the cooling, flushing, pressurization and supplying of liquid and gas-lubricated mechanical seals, e.g. quench and Thermosiphon systems, heat exchangers, buffer pressure systems, leakage monitoring and API682-compliant supply systems.

Carbon floating ring seals

Brochure 32 Pages (Code: EBES)

Maintenance-free, compact cartridge labyrinth seals with long service life and best performance from EagleBurgmann-Espey. For the sealing of gases, dust and vapors in turbines, fans, compressors, centrifuges and mills.

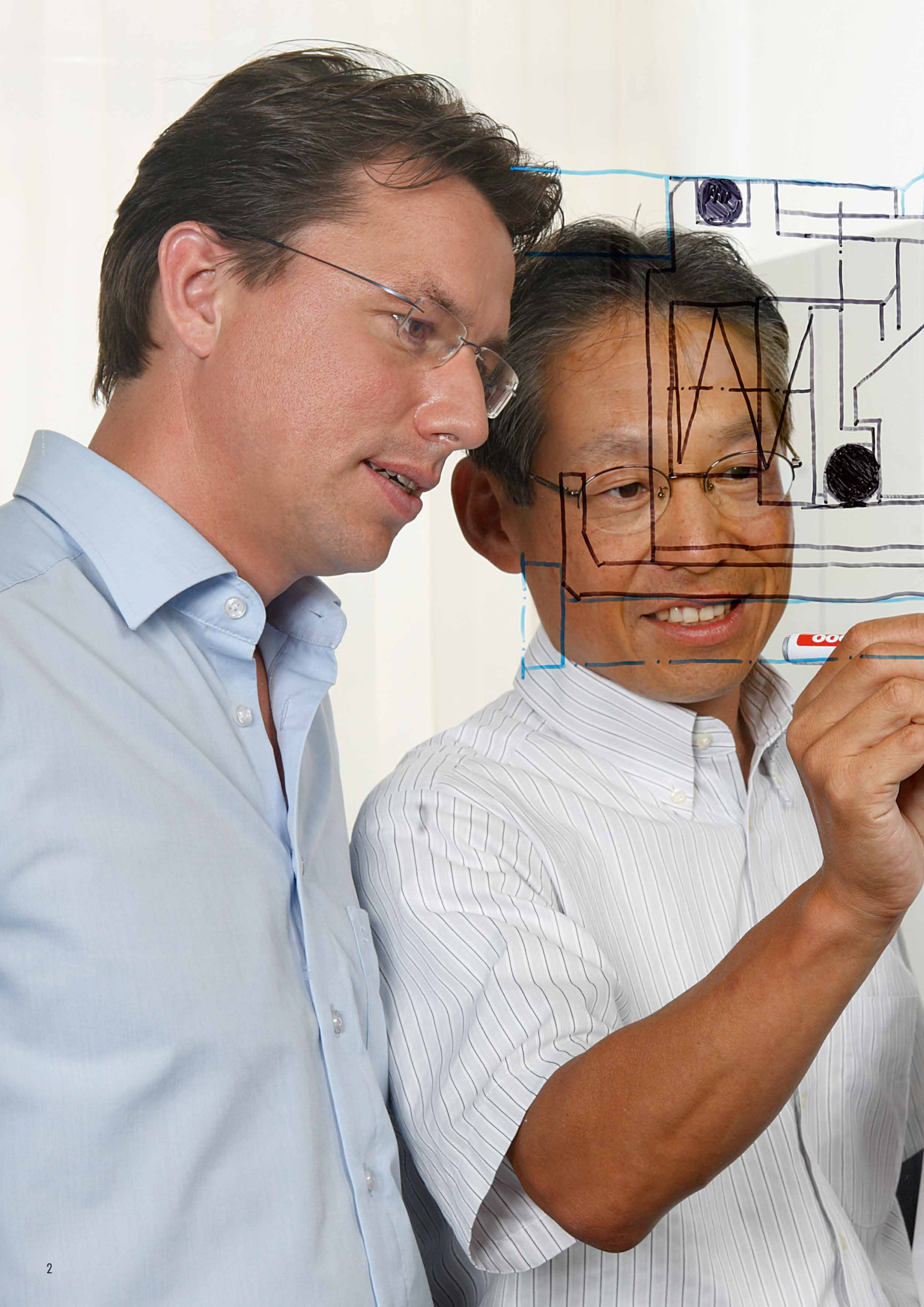

Our products – as varied as our customers



EagleBurgmann products deliver safe, reliable sealing performance in any application including oil pumping and cracking, gas compression, process gas containment, phase separation or synthesis of chemical substances, pipeline sealing, dairy product filling or compensation of temperature expansion in flue gas systems.

Our challenge is to design seals that are able to withstand a wide range of media, different aggregate states and varying pressure and temperature and to provide special solutions for small installation up to seal contact areas of several meters. Every application has its own special requirements profile, and our job is to provide the best sealing solution.

The EagleBurgmann portfolio: A product range with an unlimited horizon.

EagleBurgmann is one of the world's leading manufacturer of industrial sealing solutions. Our extensive portfolio includes everything from standard seals to one-off application-specific designs:

- Mechanical seals
- Magnetic couplings
- Seal supply systems
- Carbon floating ring seals
- Compression packings
- Gaskets
- Expansion joints
- Special products
- TotalSealCare Services

Total commitment to quality excellence.

Outstanding quality is the top priority at EagleBurgmann. Our products are designed for user-friendly installation, optimal functionality and long service life. Our R&D activities, advanced quality management system, in-house test facilities and in-depth engineering expertise ensure that our seals meet the most demanding customer expectations. Starting right back in the development phase, our employees continually verify the quality of our products, and we carry out systematic inspection and testing to guarantee that customers are getting top quality.

Proud of the trust which our customers place in us.

EagleBurgmann is a dependable, competent partner. Our customers are always in total control of the media in their pumps, agitators, compressors, blowers, turbines, valves and pipeline systems even when operating conditions are extremely harsh. There is good reason why customers in the oil & gas, refinery, chemical, energy, food processing, paper, water, marine, aerospace, mining and other industries choose EagleBurgmann as their sealing solutions supplier.



Technical information

In this brochure we collected some important and interesting technical information about the mechanical seals section. You can find – besides technical basic information – notes on design, installation and operation and also useful theoretical articles. In case of any queries, please do not hesitate to contact us.

Additional options for agitator seals	7
Axial run-out	16
Balance ratio	8
Barrier medium	17
Circulation Systems to API 682	18
Coatings for sliding faces	11
Code system for agitator seals	7
Code system for API 682 seals	21
Code system for mechanical seals	7
Coefficient of friction	8
Concentricity tolerance	15
Conical spring	15
Cooling water requirements	9
DiamondFace	11
Gap width	8
Gas-lubricated seals principle	13
Heat transfer	9
Leakage rate	11
Load factor	8
Mechanical seal installation	16
O-Ring extrusion characteristics	13
Power consumption	10
Pressure vessel regulations	17
Prior to installation	15
Pumping screws	14
Screw locking	16
Seal supply systems	17
Seat locking to EN 12756	12
Shrink disk	15
Sliding pressure	8
Sliding velocity	9
Super-Sinus spring	15
Surface finish	16
Surface roughness	9
Symbols	6
TTV O-Rings	13
Turbulence losses	9
Types of drive	15
Vapor curves	12

Table of materials and material codes:
fold-out page at back cover.

Technical information

Symbols

- A Area of sliding face
- A_H Area hydraulically loaded by medium pressure
- b Width of sliding face
- c Specific heat capacity
- D Outer diameter of sliding face
- d Inner diameter of sliding face
- D_a Outer diameter of bellows
- d_H Hydraulic diameter
- D_i Inner diameter of bellows
- d_m Mean diameter of sliding face
- D_w Diameter of shaft
- f Coefficient of friction
- F_f Spring force
- h Gap width
- H Delivery head of pumping screw
- k Balance ration
- k_1 Pressure gradient factor
- n Speed
- p_1 Medium pressure
- p_2 Atmosphere pressure
- p_3 Buffer fluid pressure
- Δp $p_1 - p_2$; $p_3 - p_1$; $p_3 - p_2$
- p_f Spring pressure
- p_G Sliding pressure
- p_r Calculated load for the frictional force of the secondary seal
- P_R Power consumption of sliding faces
- P_V Turbulence loss through rotating parts
- \dot{V} Delivery rate
- Q Mechanical seal leakage rate
- R_a Mean roughness index (calculated)
- t, T Temperature of the medium to be sealed
- ΔT Rise in temperature of the medium to be sealed
- t_3 Temperature of the buffer medium
- v_g Sliding velocity
- η Dynamic viscosity
- κ Load factor
- ρ Density
- ν Kinematic viscosity

Mechanical seals according to EN 12756 (code system)

For single mechanical seals there is a distinction drawn between standard (N) and short (K) types. For double mechanical seals (back-to-back) EN specifies the short type only.

Single seal		Position							
Designation	Description	1	2	3	4	5			
<p>N = standard type with I_{1N} K = short type with I_{1K} (C = type C)*</p> <p>U = no shaft step B = with shaft step (C = 0)*</p> <p>Nominal diameters d_s and d_{10} of the mechanical seal Shaft/shaft sleeve diameters are always three-digit numbers beneath the stationary seat for types U and B</p> <p style="text-align: center;">Direction of rotation of the mechanical seal (Type C)*</p> <p style="text-align: center;">R = clockwise Looking from the stationary seat toward the seal face with the seal face rotating in clockwise direction Looking from the drive side with the shaft rotating in clockwise direction</p> <p style="text-align: center;">L = anti clockwise Looking from the stationary seat toward the seal face with the seal face rotating in anticlockwise direction Looking from the drive side with the shaft rotating in anticlockwise direction</p> <p style="text-align: center;">S = independent of direction of rotation Spring type (state single spring or multiple springs in your order)</p> <p>Finned stationary seat 0 = no torsion lock, without anti-rotation pin 1 = with torsion lock, with anti-rotation pin (2 = for type C)*</p> <p>Materials (see inside end cover of manual for the material code)</p>		Seal face	Stationary seat	Secondary seals	Spring	Other metal parts (except seal cover and shaft sleeve)			
<p>U = no shaft step B = with shaft step (C = type C)* } on product side</p> <p>U = no shaft step B = with shaft step (C = type C)* } on atmosphere side</p> <p>Nominal diameters d_s and d_{10} (always three-digit numbers)</p> <p>Direction of rotation (see single seal)</p> <p>Anti-rotation pin for stationary seat on the atmosphere and/or product side 0 = without anti-rotation pin 1 = with anti-rotation pin for stationary seat on atmosphere side 2 = with anti-rotation pin for stationary seat on product side 3 = with anti-rotation pin for stationary seat on the atmosphere and product sides (4 = for type C)*</p> <p>Positive retention for stationary seat on the product side 0 = without D = with (E = for type C)*</p> <p>Materials (see inside end cover)</p>		Seal face inboard	Stationary seat inboard	Secondary seals inboard	Spring	Other metal parts	Sliding face outboard	Stationary seat outboard	Secondary seals outboard

* DIN 24960

Code system for agitator seals to DIN

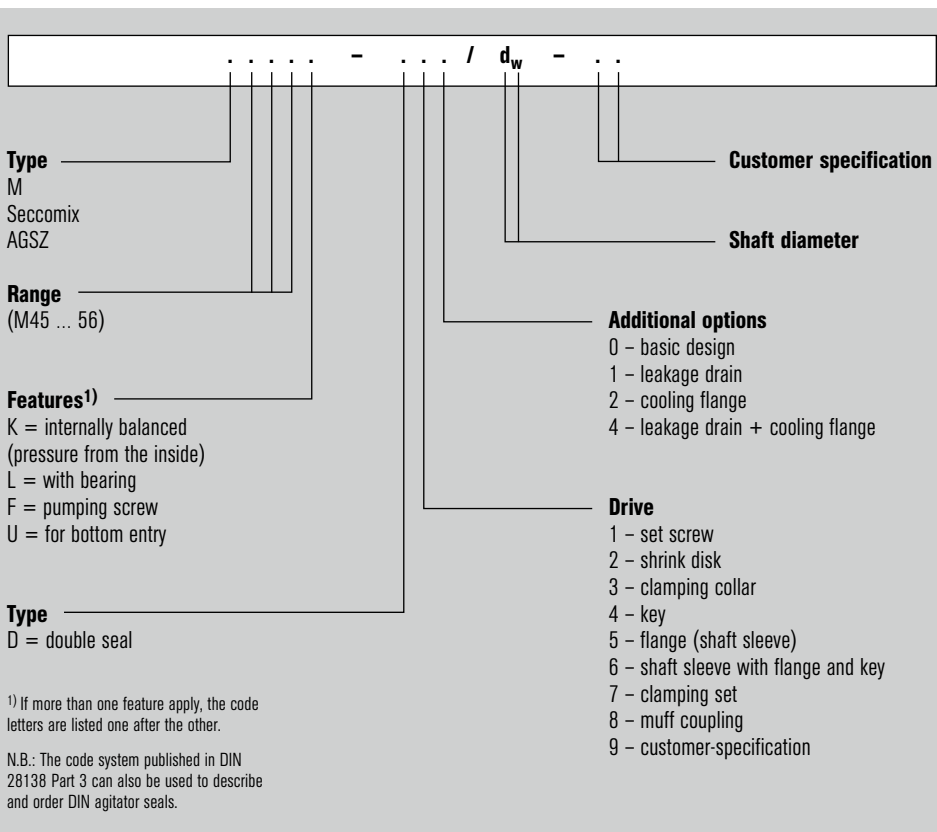

Additional options for agitator seals

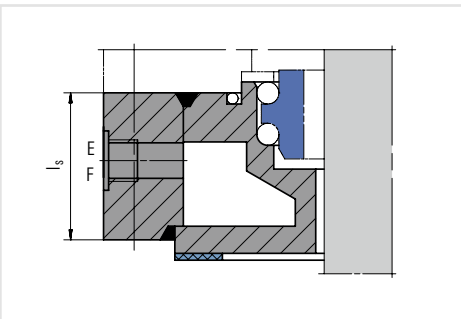

Cooling flange, can be used alternatively as a heating flange ($t_{max.} = 250\text{ °C}$ (482 °F)).

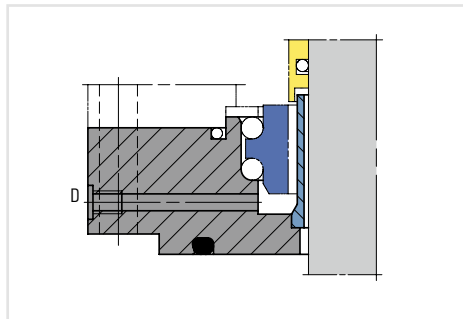

Leakage drain, can be used alternatively as a flush.

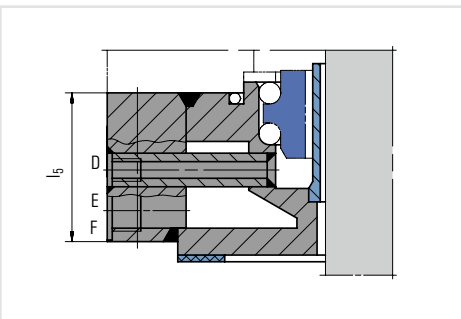

Leakage drain, can be used alternatively as a flush or as a heating flange.

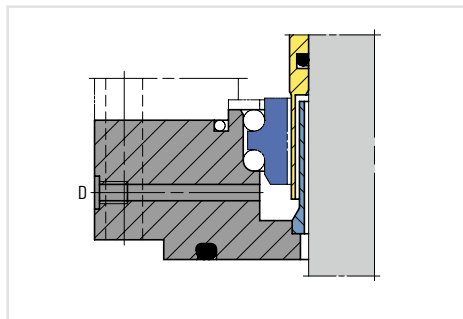

Polymerization barrier, can be used alternatively as a leakage drain or a flush.

Technical information

Balance ratio

The balance ratio is a non-dimensional factor of the mechanical seal and is defined as

$$k = \frac{\text{hydraul. loaded area } A_H}{\text{area of sliding face } A}$$

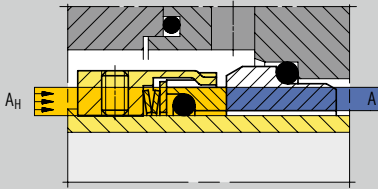

Unbalanced $k > 1$

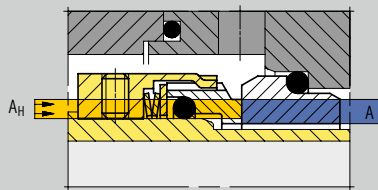

Balanced $k < 1$

In practice k values are selected between 0.65 and 1.2. With a lower k value, the safety against thermal overload will increase, but the mechanical seal may also lift off more easily.

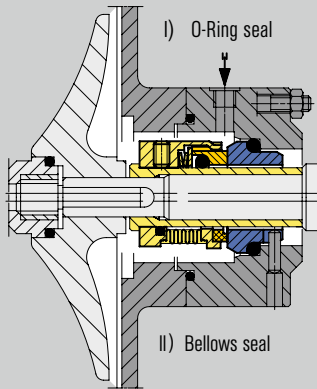

Unlike an O-Ring seal, the hydraulic diameter of a bellows seal is not a fixed geometric value. It is also influenced by the absolute level of the pressure to be sealed and by the direction of pressurization (internal or external pressure).

Sliding pressure p_G

The term "sliding pressure" is understood to be the surface pressure on the two sealing faces which remains after subtracting all those forces that act on the seal face and which are balanced by hydraulic pressures. The sliding pressure is conditional on the pressure differential to be sealed, the balance ratio, the pressure conditions inside the sealing gap i.e. gap between the seal faces (pressure gradient factor) and the spring pressure. The pressure gradient factor k_1 can assume values between 0 and 1, depending on the geometry of the two sealing faces. For

sealing gap geometries which converge in leakage direction – V-gap for externally pressurized seals – the value of k_1 is > 0.5 , while for sealing gap geometries which diverge in leakage direction – A-gap for externally pressurized seals – the value of $k_1 < 0.5$. For simplified calculations the value of k_1 is generally taken to be 0.5. Under unfavourable conditions the sliding pressure can become negative, causing the sealing faces to open resulting in excessive leakage.

$$p_G = \Delta p \cdot (k - k_1) + p_f$$

Coefficient of friction f

The coefficient of friction f is conditional on the materials that are in contact, the medium being sealed, the sliding velocity and the design-related conditions of contact between the sliding faces. For general considerations and calculations, a coefficient of friction of between 0.05 and 0.08 can be applied as a good approximation. As can be seen in the graph, a lower value is obtained under

improved conditions of lubrication, e.g. due to partial build-up of hydrodynamic pressure in the sealing gap. On the other hand, when a mechanical seal is run under purely hydrodynamic conditions of operation, the coefficient of friction will rise as the speed increases – similar to hydrodynamic bearings.

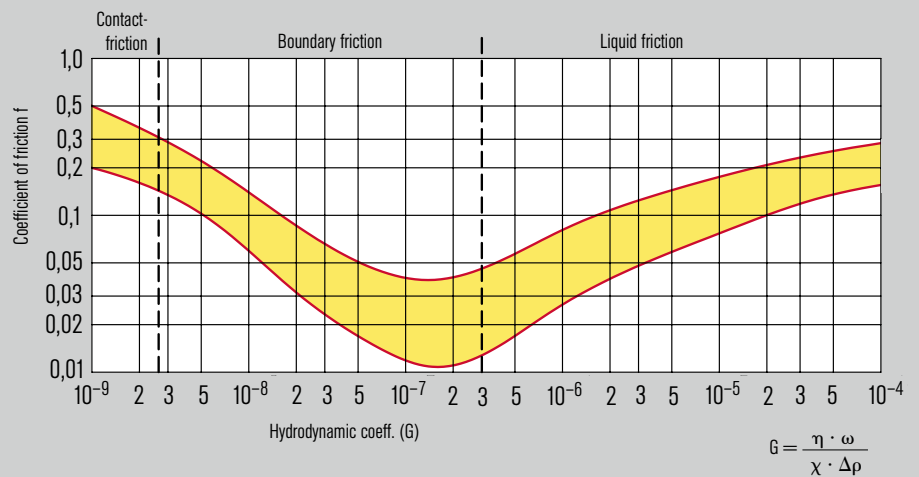

Gap width h

Seals with contacting faces

In contact seals with a theoretically parallel sealing gap, the distance between the two sealing faces is conditional on the roughness of the surfaces. Numerous measurements taken in the laboratory and in practice with due allowance for external factors indicate that a mean gap width of less than 1 mm can be used as a basis for calculating the normal degree of leakage.

Seals with non-contacting faces

Hydrostatically or hydrodynamically balanced, non-contacting mechanical seals adjust automatically to a defined gap width during operation. The width of the gap depends mainly on the shape of the gap in radial as well as circumferential direction, on the operating conditions and on the medium.

Load factor \varkappa

The balance ratio is just a non-dimensional factor used to assess a mechanical seal. A second one is the load factor \varkappa .

$$\varkappa = k + \frac{p_f \pm p_r}{\Delta p}$$

The balance ratio and the load factor are practically identical when the pressure differentials to be sealed are large. The friction at the dynamic secondary seals p_r is usually disregarded in the calculation.

Surface roughness

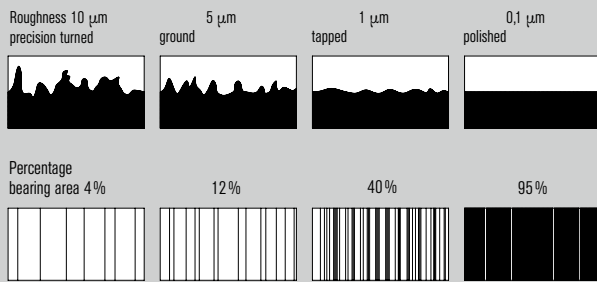

Degree of roughness in relation to the percentage bearing

Microfinished sliding faces made of various materials display the following average, arithmetic mean roughness values (R_a):

Tungsten carbide, nickel-bonded: 0,01 μm
Silicon carbide (SiC): 0,04 μm
Special cast Cr-steel: 0,15 μm

Carbon graphite: 0,10 μm
Aluminium oxide: 0,15 μm
C-SiC-Si/C-SiC: 0,15 μm

The lower the roughness value, the higher the percentage bearing area and hence the higher load capacity of a mechanical seal.

Sliding velocity v_g

The sliding velocity is usually quoted in relation to the mean sliding face diameter.

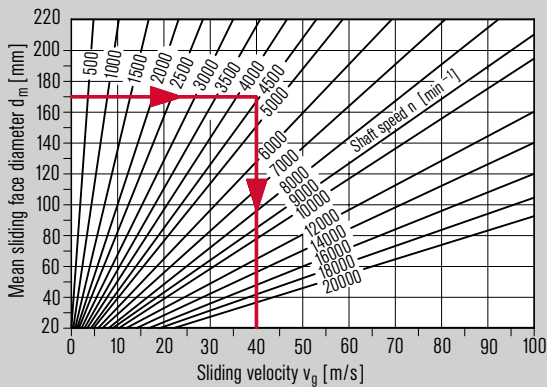

Example:
 $d_m = 170 \text{ mm}$
 $n = 4,500 \text{ min}^{-1}$
 $v_g = 40 \text{ m/s}$

Turbulence losses P_v

The turbulence-related consumption of power is not significant until the circumferential speed reaches 30 m/s (98 ft/s). It must be given due consideration particularly with special seals.

Heat transfer

The total power consumption of a mechanical seal has to be dissipated into the medium or the buffer fluid by means of appropriate measures in order to stop the seal from overheating. The necessary fluid flow rate for removal of the power losses is calculated by

$$\dot{V} = \frac{P_R + P_v}{\Delta T \cdot c \cdot \rho}$$

Under certain conditions of installation or operation heat may pass from the product to the sealing compartment and will need to be taken into account when calculating the circulation rate.

Example calculation:

$$P_R = 420 \text{ W} \quad (1 \text{ W} = 1 \frac{\text{J}}{\text{s}})$$

$$\Delta T = 10 \text{ K}$$

Fluid: Water;

$$c = 4200 \text{ J} / (\text{kg} \cdot \text{K})$$

$$\rho = 1 \text{ kg} / \text{dm}^3$$

$$\dot{V} = \frac{420 \text{ W} \cdot \text{kg} \cdot \text{K} \cdot \text{dm}^3}{10 \text{ K} \cdot 4200 \text{ Ws} \cdot 1 \text{ kg}} = 0.01 \text{ l/s} = 0.6 \text{ l/min}$$

Cooling water requirements

When estimating the amount of cooling water required by heat exchangers it can be assumed that the temperature of the cooling water will increase by 5 K between the inlet and the outlet. This means that 1 l/min of cooling water dissipates 350 W.

Technical information

Power consumption P_R of the sliding faces

The power consumption through friction of the sliding faces is calculated by the equation

$$P_R = (\Delta p \cdot k + p_f) \cdot v_g \cdot A \cdot f$$

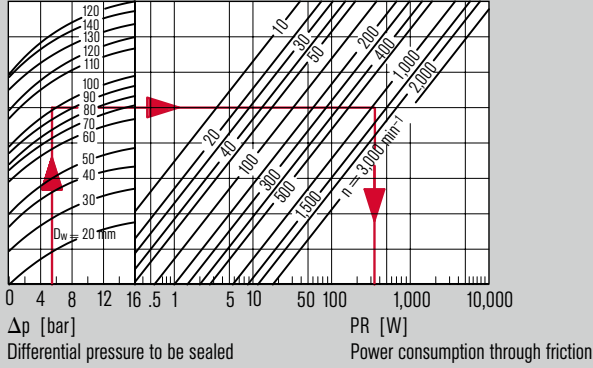

*Example M7:

$\Delta p = 5$ bar
 $D_w = 100$ mm
 $n = 1,000$ min⁻¹
 $P_R = 310$ W

* unbalanced rotating seal

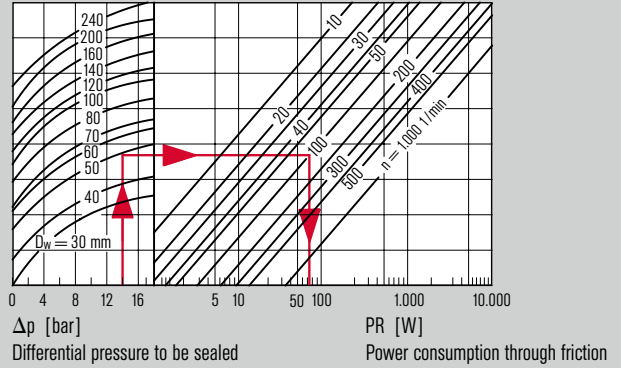

Example M48-D:

$\Delta p = 14$ bar
 $D_w = 50$ mm
 $n = 100$ min⁻¹
 $P_R = 70$ W
 Low-duty agitator seals (PN 16)

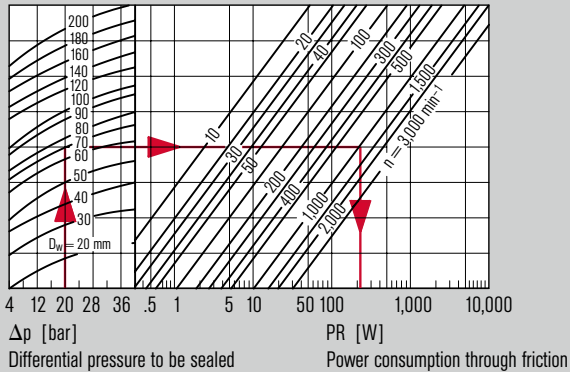

*Example H7:

$\Delta p = 20$ bar
 $D_w = 70$ mm
 $n = 1,000$ min⁻¹
 $P_R = 215$ W

* balanced rotating seal

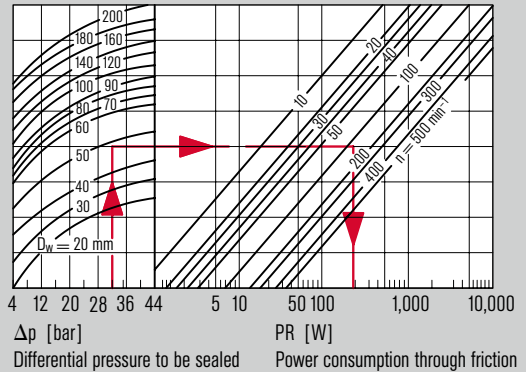

Example HS-D:

$\Delta p = 32$ bar
 $D_w = 50$ mm
 $n = 100$ min⁻¹
 $P_R = 195$ W
 Heavy-duty agitator seals (PN 40)

Power consumption

- The total power consumption of a mechanical seal is calculated from
- The power consumed by the sliding faces.
 - The power consumption due to turbulence created by the rotating parts.

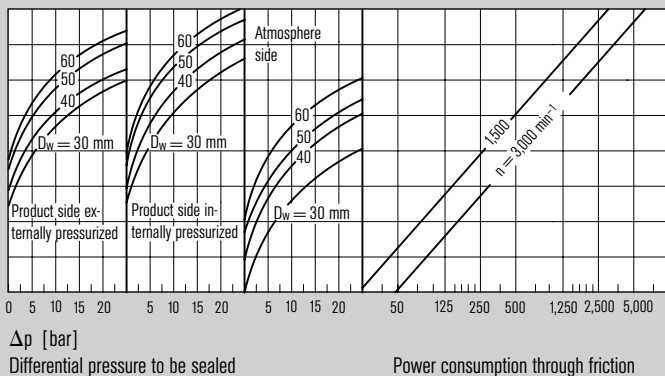

Balanced stationary seal of the HRC series

Surface technology for sliding faces

Combinations of face materials such as carbon graphite/SiC and SiC/SiC have proven excellently suitable for use in mechanical seal technology, but permanently problem-free functioning also requires adequate lubrication in the sealing gap or, where gas-lubricated mechanical seals are concerned, contactless operation.

Dry running as result of inadequate lubrication or, in the case of gas seals, contact between the sliding faces during operation, leads to massive temperature increases and possible damage to the sliding faces and secondary seals.

In order to significantly extend the service life and reliability of such seals or enable their use under extreme conditions in the first place, EagleBurgmann offers three special sliding face coatings, namely DiamondFace, Diamond-Like-Carbon (DLC) and Titanium Nitride (DM-TiN). Each of these coatings has its own particular strengths, and which of them is to be used depends on the application for which it is intended.

DiamondFace

The introduction of DiamondFace by EagleBurgmann in 2007 was a milestone in the history of mechanical seal technology. A micro-crystalline layer, which has all the attributes of natural diamond, is applied to the seal faces by means of a chemical vapor deposition (CVD) process in a vacuum reactor at a temperature of 2,000 °C (3,632 °F). Developed in cooperation with the Fraunhofer Institute for Surface Engineering and Thin Films in Braunschweig/Germany, the process produces high coating thicknesses and an extremely even seal face. Coating adhesion exceeds all known requirements in practical application.

Seal faces with DiamondFace coatings are extremely hard and wear-resistant, and exhibit low friction, excellent heat conductivity and extremely high chemical resistance. The technology increases the service life of mechanical seals used in pumps, agitators and compressors many times over. Time between maintenance calls increases considerably, and lifecycle costs are reduced significantly.



DLC (Diamond-Like-Carbon)

This hydrogenated amorphous carbon coating (a-C:H), applied by plasma enhanced chemical vapour deposition (PECVD), features excellent wear protection and friction reduction for silicon carbide seal faces. The high hardness and the specially designed surface offer great protection against scoring. DLC is used as standard coating for silicon carbide seal faces and is only surpassed by the extraordinary properties of the DiamondFace coating. In terms of material properties, the a-C:H DLC coating is to classify between diamond and carbon graphite.

DM-TiN Titanium Nitride

The DM-TiN titanium nitride coating (Standard: 1.4006/SU410, Japanese patent no. 2134661) is applied by means of an ion beam mixing process, and exhibits outstanding microhardness and excellent adhesive properties due to the fact that it penetrates the metal and forms a tight metallurgical bond.

Titanium nitride coatings are used as start-up protection for metallic seal faces on compressor seals (e. g. MDGS). DM titanium nitride/carbon graphite combinations have a good friction coefficient and exhibit excellent emergency running properties.

Leakage rate Q

Calculated rates of leakage and power losses are not guaranteed values. They are statistical and calculated mean values which are determined on the basis of experience and extensive testing. The leakage rates and power losses which actually arise in a particular seal can be several times higher on account of factors that are impossible to quantify theoretically. As can be seen from formula, the leakage rate is mainly conditional on the actual gap width during operation. This depends in turn on many factors (see also gap width).

Factors influencing leakage

The major factors with an influence on a mechanical seal's leakage rate, correct functioning and reliability include:

- Machined finish of the sliding faces
- Flatness of the sliding faces and flatness deviations caused by thermal or pressure-induced deformations
- Machine vibrations or stability
- Mode of operation of the plant
- Characteristics of the medium to be sealed
- Correct installation of the mechanical seal

Formula for externally pressurized mechanical seals

$$Q = \frac{h^3}{\eta \cdot \ln\left(\frac{D}{d}\right)} \left[1,885 \cdot 10^{-4} \cdot \Delta p - 7,752 \cdot 10^{-19} \cdot \rho \cdot n^2 \cdot (D^2 - d^2) \right]$$

Example calculation for a H7N/48 seal

$$Q = \frac{0,27^3}{4,7 \cdot 10^{-4} \cdot \ln\left(\frac{56,9}{51,9}\right)} \left[1,885 \cdot 10^{-4} \cdot 18 - 7,752 \cdot 10^{-19} \cdot 983 \cdot 3000^2 \cdot (56,9^2 - 51,9^2) \right]$$

$$Q = 1,543 \text{ ml/h}$$

$D = 56,9 \text{ mm}$ $h = 0,27 \mu\text{m}$
 $d = 51,9 \text{ mm}$ $\Delta p = 18 \text{ bar}$
 $n = 3000 \text{ min}^{-1}$ $\rho = 983 \text{ kg/m}^3$
 $\eta = 4,7 \cdot 10^{-4} \text{ Pa} \cdot \text{s}$

Technical information

Vapor curves

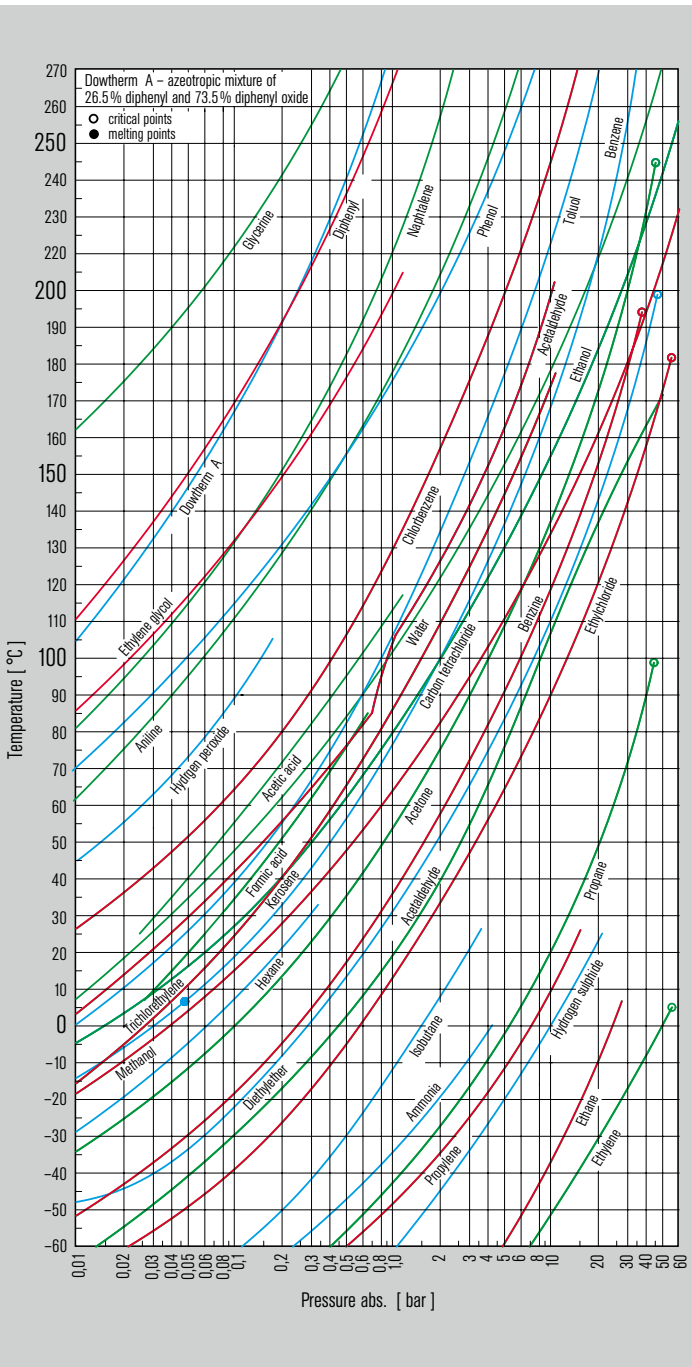

- Acetaldehyde
- Acetone
- Formic acid
- Ammonia
- Aniline
- Benzene
- Benzene
- Chlorobenzene
- Diethyl ether
- Diphenyl
- Dowtherm A
- Acetic acid
- Ethanol
- Ethane
- Ethylchloride
- Ethylene glycol
- Ethylene glycol
- Glycerine
- Isobutane
- Hexane
- Kerosene
- Methanol
- Naphtalene
- Phenol
- Propane
- Propylene
- Hydrogen sulphide
- Carbon tetrachloride
- Trichloroethylene
- Toluol
- Water
- Hydrogen peroxide

Seat locking*) to EN 12756

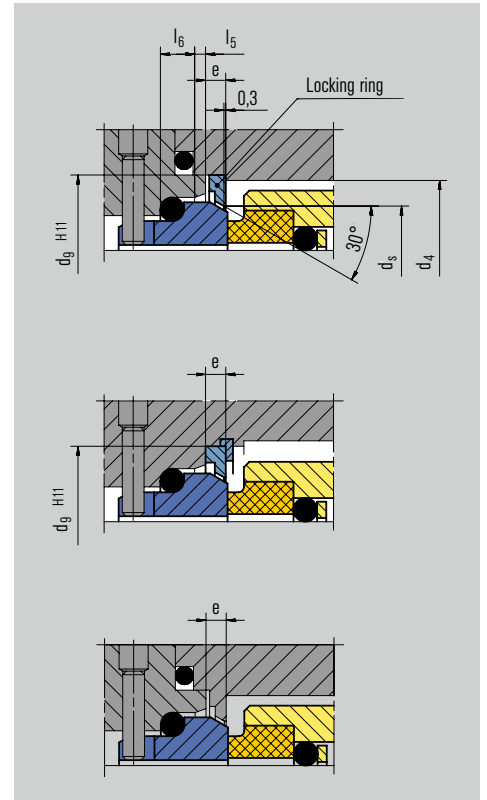

d ₁	d ₂	U		B		U	B	l ₅	l ₆	e	d _s
10	14	22	26	26	30	1.5	4	4	4	-	-
12	16	24	28	28	32	1.5	4	4	4	-	-
14	18	26	34	30	38	1.5	4	4	4	-	-
16	20	28	36	32	40	1.5	4	4	4	-	-
18	22	34	38	38	42	2.0	5	4	4	31.2	-
20	24	36	40	40	43	2.0	5	4	4	33.2	-
22	26	38	42	42	46	2.0	5	4	4	35.2	-
24	28	40	44	43	48	2.0	5	4	4	37.2	-
25	30	41	46	46	50	2.0	5	4	4	38.2	-
28	33	44	49	48	53	2.0	5	4	4	41.2	-
30	35	46	51	50	60	2.0	5	4	4	43.2	-
32	38	48	58	53	62	2.0	5	4	4	46.2	-
33	38	49	58	53	62	2.0	5	4	4	46.2	-
35	40	51	60	60	65	2.0	5	4	4	48.2	-
38	43	58	63	62	67	2.0	6	6	6	53.5	-
40	45	60	65	65	70	2.0	6	6	6	55.5	-
43	48	63	68	67	72	2.0	6	6	6	58.5	-
45	50	65	70	70	75	2.0	6	6	6	60.5	-
48	53	68	73	72	77	2.0	6	6	6	63.5	-
50	55	70	75	75	86	2.5	6	6	6	67.5	-
53	58	73	83	77	88	2.5	6	6	6	70.6	-
55	60	75	85	86	91	2.5	6	6	6	72.6	-
58	63	83	88	88	93	2.5	6	6	6	75.6	-
60	65	85	90	91	96	2.5	6	6	6	77.6	-
63	68	88	93	93	98	2.5	6	6	6	80.6	-
65	70	90	95	96	103	2.5	6	6	6	82.6	-
68	-	93	-	98	-	-	-	-	6	88.6	-
70	75	95	104	103	108	2.5	7	6	6	90.2	-
75	80	104	109	108	120	2.5	7	6	6	95.2	-
80	85	109	114	120	125	3.0	7	6	6	103.0	-
85	90	114	119	125	130	3.0	7	6	6	108.0	-
90	95	119	124	130	135	3.0	7	6	6	113.0	-
95	100	124	129	135	140	3.0	7	6	6	117.5	-
100	105	129	134	140	145	3.0	7	6	6	122.5	-

* not applicable for seats made of carbon

A sealing system for hydrocarbons must often make allowance for partial dry running due to their low boiling points. However with the right design features and face materials, it is possible to guarantee failsafe operation of the mechanical seal. The operating temperature must be at least 5 K lower than the boiling point under operating pressure.

Extrusion characteristics of elastomeric O-Rings

The extrusion resistance of elastomeric O-Rings can be greatly enhanced by the use of support rings.

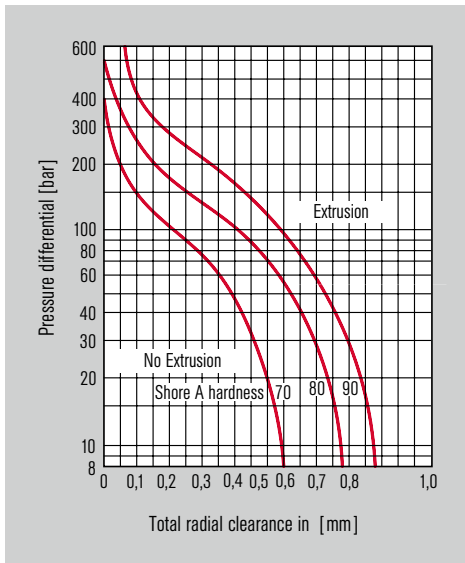

TTV O-Rings

Double PTFE-encapsulated O-Rings of the type used in EagleBurgmann mechanical seals combine the elasticity of the core materials (synthetic rubber) with the chemical and thermal resistance of the PTFE.

The material PTFE features good chemical and thermal resistance but it also displays a high degree of rigidity, a low coefficient of thermal conductivity, an unfavourable expansion characteristic and a tendency to cold flow. It is advisable therefore to avoid the use of O-Rings made of solid PTFE.

The assembly position of double PTFE-encapsulated elastomers is critical. Care must be taken to ensure that the joint on the outer jacket faces against the assembly direction, as otherwise there is a risk of the jacket opening and being pulled off. Bending of the jacket must be avoided at all costs to prevent leaks. Slip TTV rings onto tubes for safe storage.

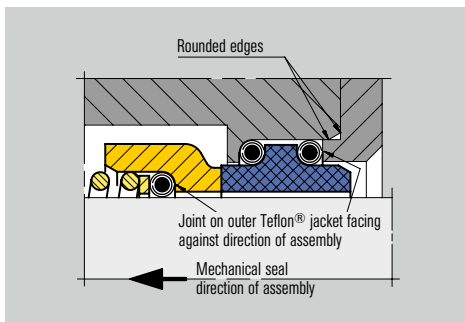

Functional principle gas-lubricated seals

In its basic design and mode of operation, the EagleBurgmann Gas Seal is the same as a conventional mechanical seal except for two differences: a) the sliding faces are wider, and b) they are lubricated by gas rather than liquid.

This is assured in outstanding manner by the sophisticated geometry of V- and U-grooves in the sliding faces. Even at low speeds a stable gas film develops in the sealing gap to separate the sliding faces and guarantee non-contacting, wear-free operation, at a minimum level of power consumption that is 95 % below that of liquid-lubricated seals.

Elaborate buffer fluid oil systems for the lubrication and cooling of double seals are superfluous. Gas pressurization at a level of around 5 to 10 % above product pressure (p_1) makes sure that no process medium can escape to the atmosphere. A small gap height of approximately 3 μm between the sliding faces results in minimum consumption of buffer gas of a magnitude that depends largely on the pressure, speed and seal diameter.

V-grooves

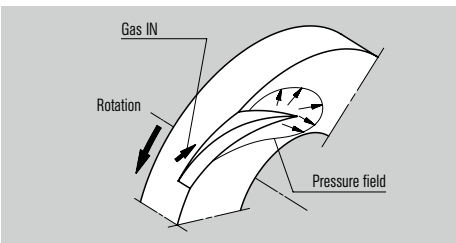

The V-grooves convey the gas by a rotary movement between the sliding faces. The resulting pressure rise causes the seal faces to lift off and ensures a contact-free operation. V-grooves are **dependent** on the direction of rotation.

U-grooves

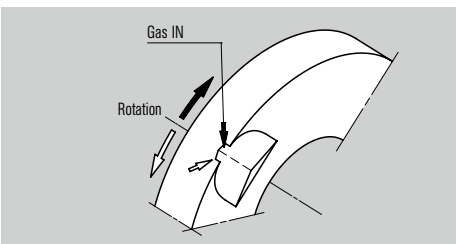

For sliding faces featuring U-grooves, the operating principle is similar to that for V-grooves, with one decisive difference: the direction of rotation is **independent**.

Technical information

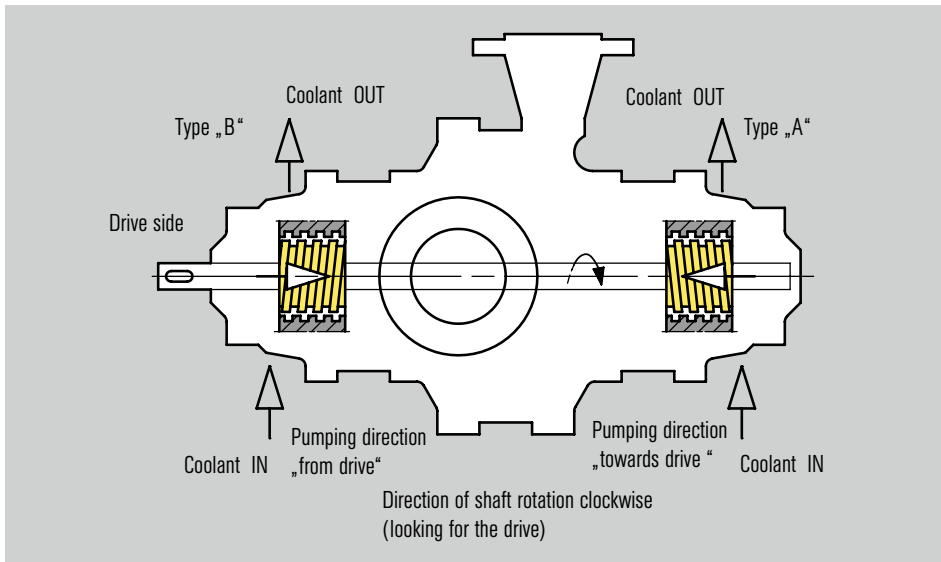

Contra-rotating pumping screw.

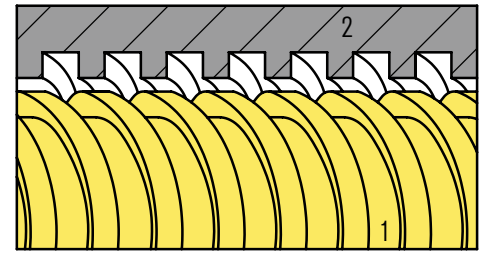

1 Pumping screw
2 Pumping sleeve

Pumping screw

Pumping screws are used to boost the circulation of coolant for single and double mechanical seals. The direction of flow, delivery head and delivery rate can be adapted to the given operating conditions by suitable design measures.

Pumping screws are **dependent on the direction of rotation**. An "F" in the drawing number stands for a pumping screw. It follows after the type code. The optimum arrangement is afforded by the **contra-rotating pumping screw** where the thread of the stationary screw (pumping sleeve) faces in opposite direction to the rotating thread (pumping screw).

Explanation

The diagram shows a multi-stage centrifugal pump with **clockwise** rotation (looking from the drive side), a **type B** mechanical seal with pumping direction **"from drive"** on the drive side and a **type A** mechanical seal with pumping direction **"towards drive"** on the non-drive side.

Direction of shaft rotation (looking from drive)	Pumping direction	Pumping screw type	Coding of components
Right	Towards drive	A	Pumping screw AR Pumping sleeve AL
	From drive	B	Pumping screw BL Pumping sleeve BR
Left	Towards drive	B	Pumping screw BL Pumping sleeve BR
	From drive	A	Pumping screw AR Pumping sleeve AL

Pumping capacity of various pumping screws with pumping sleeve

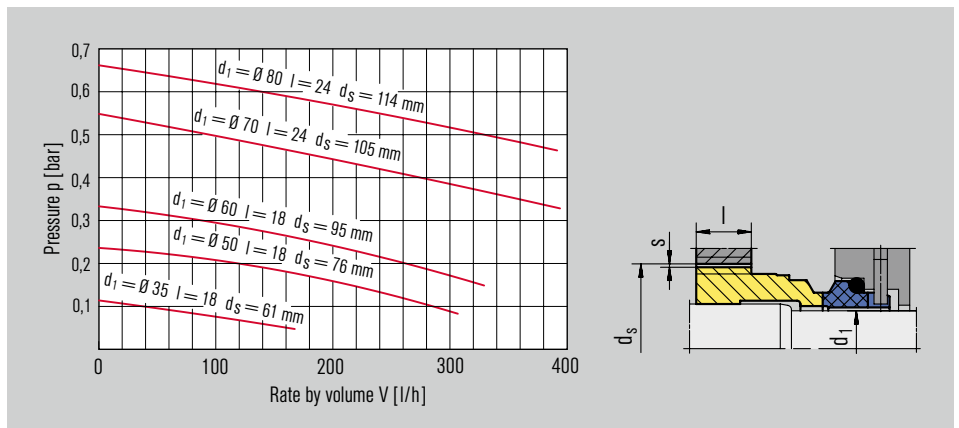

Pumping capacity of various pumping screws without pumping sleeve

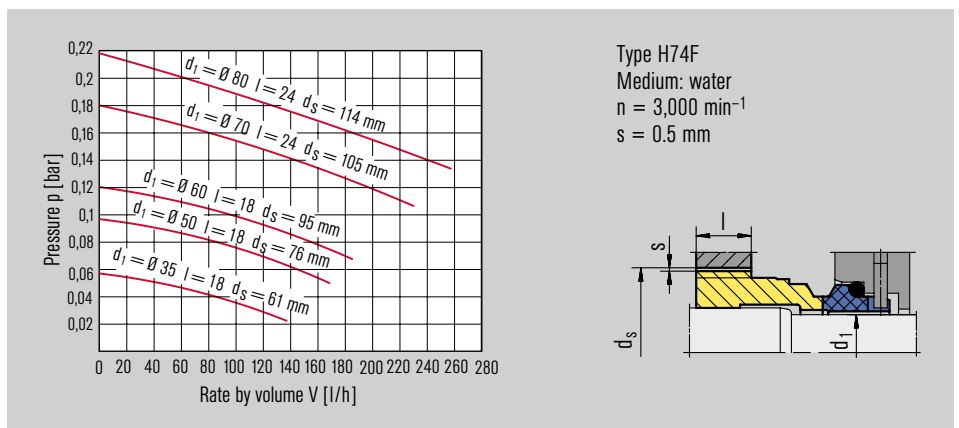

Super-Sinus spring

The Super-Sinus spring permits an almost uniform introduction of forces over the whole range of increased axial movement tolerances of mechanical seals, e.g. M7N/H7N. The one-piece spring is endless and has a very flat characteristic. The Super-Sinus spring has no welding spots to minimize corrosion. It is regularly made of 1.4571, optionally of Hastelloy®.

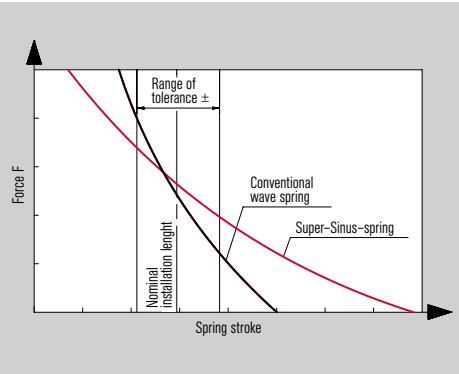

Conical spring

When a conical spring is used for driving the seal (e.g. in standard types M2 and M3), the mechanical seal becomes **dependent on the direction of rotation**. Looking toward the sliding face of the rotating parts of the seal, shafts rotating in clockwise direction require right-hand springs and shafts rotating in anticlockwise direction require left-hand springs. Mounting the conical spring is easier if you twist it onto the shaft with a screwing action in the same direction as the spring coiling. This screwing action will cause the spring to open. For brief reversals of the direction of rotation we recommend seal type "S30".

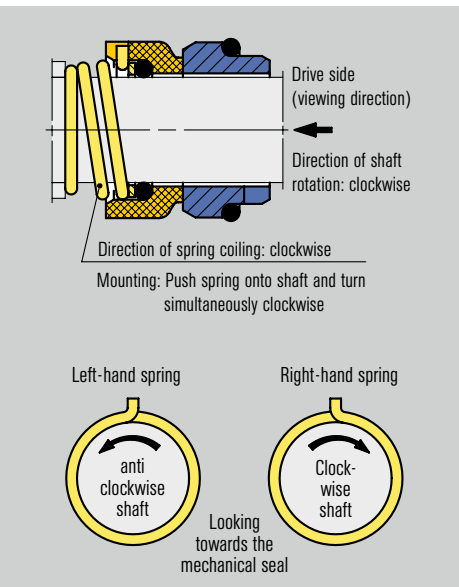

Types of drive

For a seal to function properly, the shaft torque must be transmitted uniformly to the shaft sleeve and/or rotating parts under all operating conditions. Depending on the seal design it is necessary to make allowance for centrifugal and axial forces and in some case to observe special installation instructions. Incorrect fitting can cause, for example, jamming and deformation of the seal.

Typical arrangements

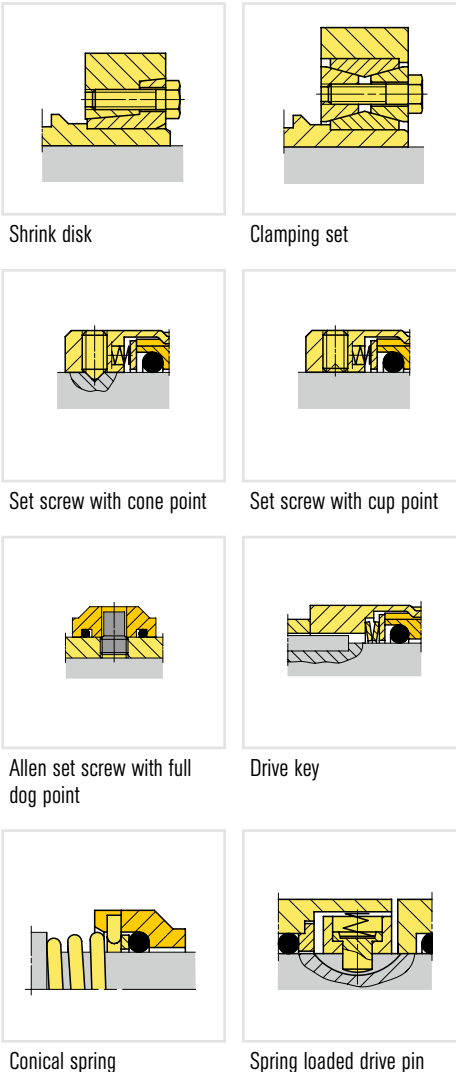

Shrink disk

The pressure necessary for the transmission of torque is generated through clamping force on lubricated conical surfaces. The shrink disk couplings can be released at any time by slackening the tensioning screws. All the parts involved are subjected to elastic deformation only, so the original clearance is restored once the screws are released. Provided the conical surfaces are undamaged, the shrink disks can be retensioned any number of times (ensure correct lubrication). Shaft sleeves should not have a clearance diameter under the shrink disk and should make full contact with the shaft.

Prior to installation

To fit a seal you will need its installation and operating instructions with the correct drawing. Before starting, check the dimensions, the maximum acceptable deviations and the geometrical tolerances of the machine.

Edges and shoulders

All edges and shoulders onto or into which the mechanical seal is pushed during installation must be chamfered, deburred and rounded off to less than 30° x 2 mm.

Dimensional deviations

Acceptable deviations for dimensions having no tolerance specification:

- ISO 2768 Part 1, fine/medium for linear and angular dimensions
- Part 2, tolerance class K for general geometrical tolerances

Concentricity tolerance

Shaft in accordance with ISO 5199

In the area of the mechanical seal the shaft concentricity tolerance must not exceed 50 µm for diameters < 50 mm, 50 µm, 80 µm for diameters between 50 and 100 µm, and 110 µm for diameters > 100 mm.

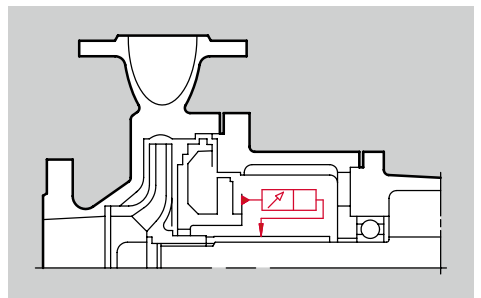

Seal chamber bore

For sliding velocities of $v_g < 25$ m/s the concentricity tolerance of the seal chamber in relation to the shaft should not exceed 0.2 mm, and when pumping screws are used it should not exceed 0.1 mm due to the effect of the pumping characteristic. If these values are exceeded please contact EagleBurgmann.

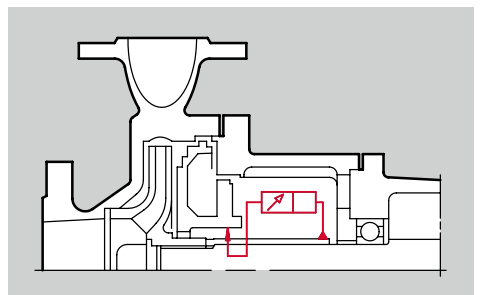

Technical information

Axial run-out

Mounting face

Axial run-out depends on the speed. Permissible values are indicated by the graph.

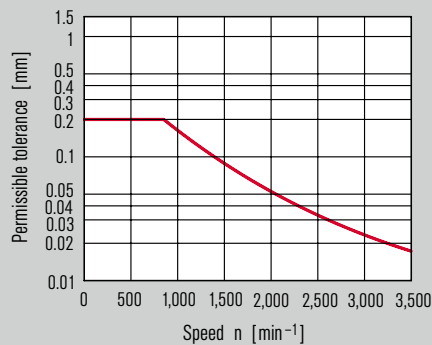
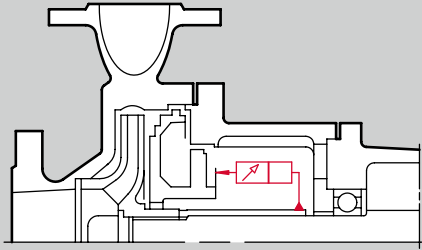

Surface finish

Finished surfaces according to EN 12756

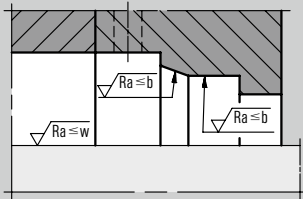
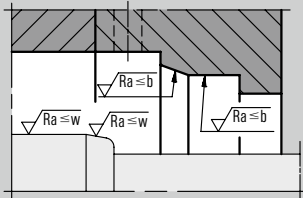

Mean roughness index	R _a for secondary seal material	
	b	w
Elastomers	2.5 μm	0.8 μm
Non-elastomers or optional use of elastomers and non-elastomers	1.6 μm	0.2 μm

Mechanical seal installation

Absolute cleanliness and care are essential when fitting mechanical seals. Dirt and damage to sliding faces and O-Rings jeopardize a seal's function. Any protective covering on the sliding faces must be removed without trace. Never put lubricant on the sliding faces – mount only in a completely dry, dustfree and clean state. The accompanying installation instructions and the notes on the assembly drawings must be observed exactly.

Fitting advice

To reduce the friction on O-Rings when mounting seals on a shaft or when inserting seal cartridges in their housing, apply a thin coating of silicon grease or oil to the shaft or housing (N.B.: this does not apply to elastomer bellows seals). Never allow EP rubber O-Rings to come into contact with mineral oil or grease. When inserting stationary seats, be careful to apply even pressure and use only water or alcohol to reduce O-Ring friction.

Series MG

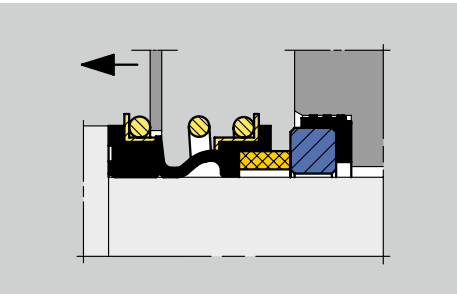

Use normal or soapy water (with a surfactant) to mount elastomer bellows seals of the MG series on the shaft. Wet the seal seat and the shaft thoroughly and keep wet if the distance to slide the seal is rather long. Never use oil or grease! After completing the assembly, check that the rings, springs and seal face sit correctly and tight.

Series MFL

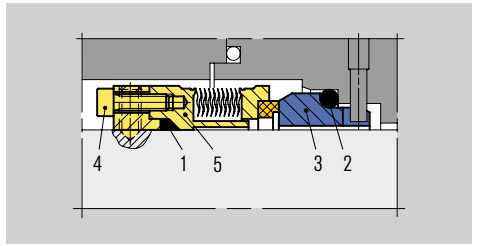

Never over-compress metal bellows seals. Apply the axial mounting force needed to push the seal onto the shaft via the bellows drive collar.

Points to note when using Statotherm[®] moulded rings (e.g. MFLWT80):

- Install moulded rings (Item 1 and 2) in the dry state only and compress in axial direction only (radial deformation would result in their destruction).
- Apply even pressure to insert the moulded ring (Item 2) and the stationary seat (Item 3) in the recess (concentricity tolerance!).
- Tighten the screws (Item 4) in the rotating part gradually and in circular succession (not cross-wise) in several steps, keeping the gap as even as possible.

Venting

To prevent damage to the sliding faces from dry running, the buffer space must be carefully vented **after you have installed the seal**. This is particularly important for those types of buffer/barrier fluid systems that do not vent themselves or are partially self venting (double seal with buffer/barrier fluid systems).

Screw locking

If no special provision is made for locking screw thread, use set screw with a suitable adhesive (e.g. Loctite[®]) after removing any grease.

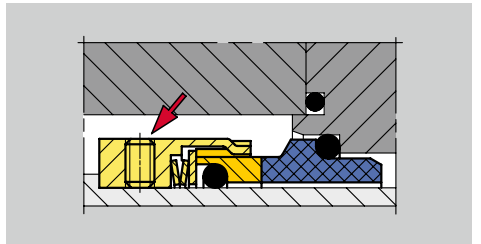

Seal supply systems

Circulation

For single seals it is generally advisable to install a circulation pipe from the discharge nozzle of the pump to the seal chamber. A pipe size G 1/4 is normally sufficient. There should be a close fitting neck bush between the pump casing and the seal chamber.

Flushing

Flushing systems are installed in accordance with ISO 5199, Appendix E, Plan No. 08a or API 682, Appendix D, Plan 32. A clean and mostly cold external medium is injected into the stuffing box in the area of the sliding faces via an orifice (throttle) into the medium to be sealed. Flushing is used either to lower the temperature or to prevent deposits forming in the area of the mechanical seal. Again it is recommended that a close fitting neck bush is employed.

Quench

Quench is the term commonly used in sealing engineering for an arrangement that applies a pressureless external medium (fluid, vapour, gas) to a mechanical seal's faces on the atmosphere side. A quench is used on the one hand when a single mechanical seal does not function at all or only within certain limits without auxiliary measures or when a double mechanical seal with pressurized barrier medium is unnecessary. When an integral stationary seat stop is fitted, the quench pressure should not exceed 1 bar. A quench performs at least one of the duties described below.

Fluid quench

- Absorption or removal of leakage by the quench medium
- Monitoring of the mechanical seal's leakage rate by periodic measurement of the level of the quench medium in the circulation vessel or thermosiphon vessel
- Lubrication and cooling of the standby mechanical seal
- Exclusion of air: For media which react with atmospheric oxygen the quenching medium stops the leakage making contact with the atmosphere
- Protection against dry running: For applications subject to brief, periods of vacuum and operation of pumps without pumping liquid (submersible pumps) the quenching medium prevents dry running of the mechanical seal
- Stabilization of the lubrication film: For operation under vacuum and/or sealing pressures close to the vapour pressure, the quenching medium stabilizes the lubrication film
- Cooling or heating of the outboard side of the mechanical seal.

Steam quench

- Heating: For media with a high melting point the vapour quench prevents the leakage from solidifying in that area of the mechanical seal critical for its proper functioning
- Exclusion of air
- Removal of leakage

Gas quench

- Icing protection: With operating temperatures $< 0\text{ }^{\circ}\text{C}$ (cryogenic mechanical seals), the injection of nitrogen or dry air into the seal housing prevents the mechanical seal parts on the atmosphere side from icing up
- Exclusion of air
- Removal of leakage

Sealing the quench medium

- Outboard mini-gland – the preferred choice for steam, not so much for liquids
- Lip seals – the preferred choice for oils and water
- Mechanical seals – the preferred choice for all circulating quench fluids

Barrier system

To guarantee the correct working of double mechanical seals, the barrier interspace (between the product side and the atmosphere side of the mechanical seal) must be completely filled with clean barrier medium. Before starting up double mechanical seals it is vital, therefore, to ensure a sufficient rate of circulation of the barrier fluid. The barrier fluid pressure should lie 10 % or at least 2...3 bar above the maximum pressure to be sealed. The flow rate must be controlled to ensure that the temperature of the barrier medium at the outlet lies below approximately $60\text{ }^{\circ}\text{C}$ and that it does not exceed boiling point under any circumstances. The maximum acceptable inlet/outlet temperature differential is 15 K. The barrier fluid outlet lies at the highest point of the stuffing box for automatic venting of any vapour.

In view of the basic conditions of operation, a barrier system must perform the following functions:

- Build-up pressure in the barrier inter space
- Compensation of leakage
- Circulation of the barrier medium
- Cooling of the barrier medium
- Cooling of the seal

Barrier fluid systems for liquid-lubricated mechanical seals break down into two basic categories:

- **Open circuit** A circuit in which both the circulation and the pressurization take place through a single barrier fluid system (e.g. SPA). After each circuit the barrier fluid is relieved and collected in a pressureless tank.
- **Closed circuit** In this type of circuit all the components are kept under the same pressure. Pressure is applied by means of nitrogen (TS system) or the process medium pressure (DRU system), or via a refill system (SPN). Pressure loss in the circuit must be taken into account when drawing up the design.

Pressure vessel regulations

Requirements imposed by the German Pressure Vessel Code on Group III pressure vessels (Section 8)

- Section 4 of the German Pressure Vessel Code orders that pressure vessels be built and operated in accordance with the generally valid rules of engineering (such as the German AD Code).
- AD Bulletin W2 requires every pressure-bearing part made of austenitic steel to be accompanied by a material certificate EN 10204 3.1 B or 3.1 C.
- The manufacturer must subject every pressure vessel to a pressure test.
- Every pressure vessel must be issued with a certificate confirming its correct production and pressure testing in accordance with the Pressure Vessel Code. This certificate is included with the delivery.

Barrier medium

The barrier medium fulfils two functions – it dissipates the heat generated by the seal and it prevents the product from penetrating the sealing gap to any appreciable degree. Any liquid and any gas can be chosen as barrier medium, with due consideration to the corrosion resistance of the parts it comes into contact with and to its compatibility with the process medium and surroundings. The barrier medium must not contain any solids. It is particularly important that liquid barrier media do not tend to precipitate and that they have a high boiling point, a high specific thermal capacity and good thermal conductivity. Clean, demineralised water satisfies these requirements to a high degree.

Hydraulic oil is often used in buffer fluid units and water in closed barrier fluid circuits. To prevent damage to the TS and sealing system, due allowance must be made for the coefficients of volumetric expansion of the barrier fluids used.

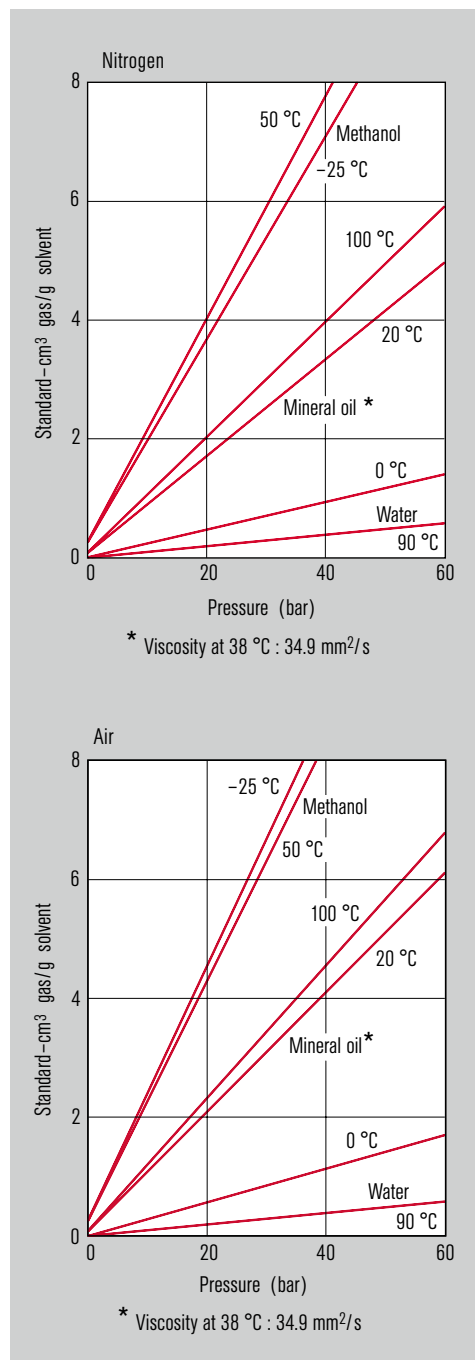

Gas solubility in typical barrier media

Technical information

Piping plans in accordance with API 682 4th edition

Process side

Plan 01

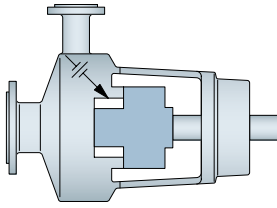

Integral (internal) recirculation from the pump discharge to the seal chamber.

Plan 12

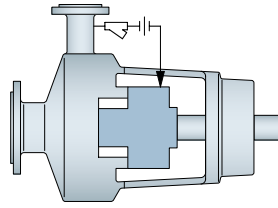

Recirculation from the pump discharge through a strainer and a flow control orifice into the seal chamber.

Plan 22

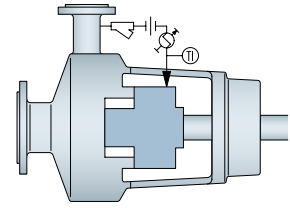

Recirculation from pump discharge through a strainer, a flow control orifice and a cooler into the seal chamber.

Plan 02

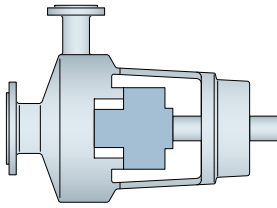

Dead-ended seal chamber with no recirculation of flushed fluid. Flush connections plugged.

Plan 13

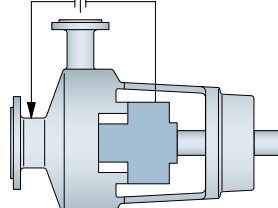

Recirculation from the seal chamber through a flow control orifice and back to the pump suction or pump suction piping.

Plan 23

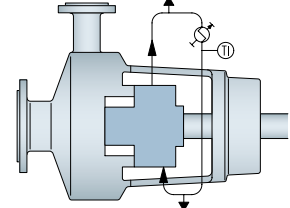

Recirculation from a circulation device in the seal chamber through a cooler and back into the seal chamber.

Plan 03

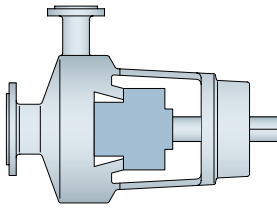

Circulation between the seal chamber and the pump created by the design of the seal chamber. Flush connections plugged.

Plan 14

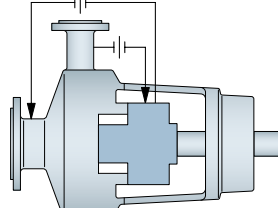

Recirculation from pump discharge through a flow control orifice to the seal and simultaneously from the seal chamber through a flow control orifice to pump suction.

Plan 31

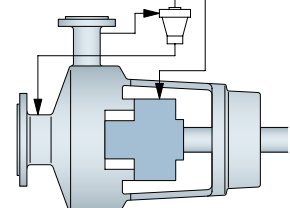

Recirculation from the pump discharge through a cyclone separator delivering the clean fluid to the seal chamber. The solids are delivered to the pump suction line.

Plan 11

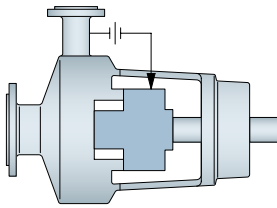

Recirculation from the pump discharge through a flow control orifice into the seal chamber.

Plan 21

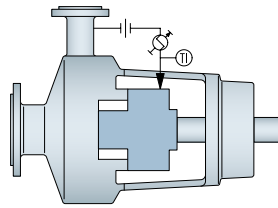

Recirculation from pump discharge through a flow control orifice and cooler into the seal chamber.

Plan 41

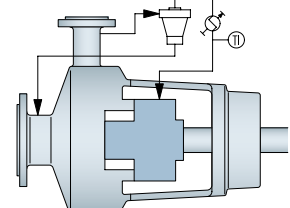

Recirculation from the pump discharge through a cyclone separator delivering the clean fluid to a cooler and then to the seal chamber. The solids are delivered to the pump suction line.

Plan 32

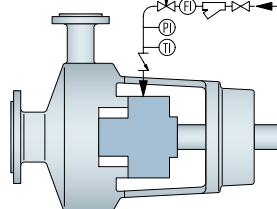

Injection of clean fluid into the seal chamber from an external source.

Instrument symbols

FO	Flow orifice	TI	Temperature indicator
LI	Level indicator	TIT	Temperature transmitter with local indicator
LIT	Level transmitter with local indicator	HLA	High level alarm set point
DPIT	Differential pressure transmitter with local indicator	LLA	Low level alarm set point
PI	Pressure indicator	NLL	Normal liquid level
PIT	Pressure transmitter with local indicator	FI	Flow indicator
		FIT	Flow transmitter with local indicator

Between seals

Plan 52

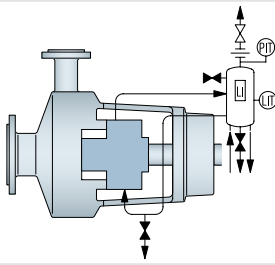

Reservoir providing buffer liquid for the outer seal of an arrangement 2 unpressurized dual seal. The buffer liquid shall be maintained at a pressure less than seal chamber pressure and less than 2.8 bar (40 PSI).

Plan 55

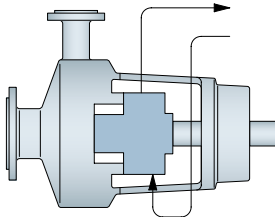

Unpressurized external buffer fluid system supplying clean buffer liquid for the outer seal of an arrangement 2 unpressurized dual seal. Buffer liquid is circulated by an external pump or pressure system.

Plan 53A

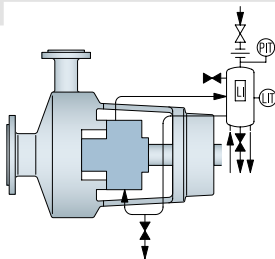

Pressurized barrier fluid reservoir supplying clean fluid for an arrangement 3 pressurized dual seal.

Plan 53B

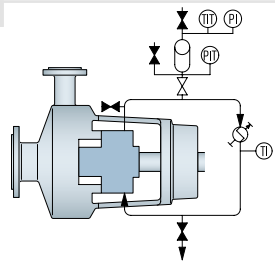

Barrier fluid system pressurized by a bladder accumulator supplying clean liquid for an arrangement 3 pressurized dual seal.

Plan 53C

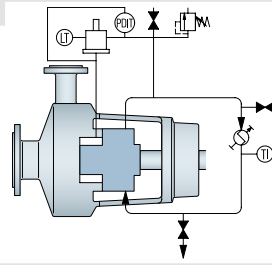

Barrier fluid system pressurized by a piston accumulator supplying clean liquid for an arrangement 3 pressurized dual seal. The barrier pressure is generated from the seal chamber pressure. The system is self-energizing and reacts to fluctuations in the seal chamber fluid pressure.

Plan 54

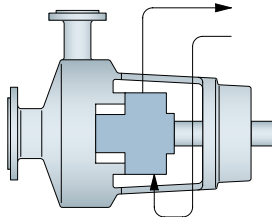

Pressurized external barrier fluid system supplying clean liquid for an arrangement 3 pressurized dual seal. The barrier liquid is maintained at a pressure greater than seal chamber pressure and is circulated by an external pump or pressure system.

Plan 72

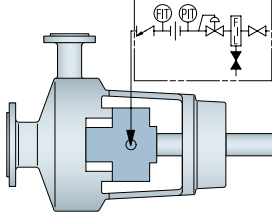

Externally supplied buffer gas for arrangement 2 unpressurized seals with a dry running containment seal (2CW-CS and 2NC-CS). Buffer gas is maintained at a pressure less than seal chamber pressure. The buffer gas pressure should not exceed 0.7 bar (10 PSI).

Plan 71

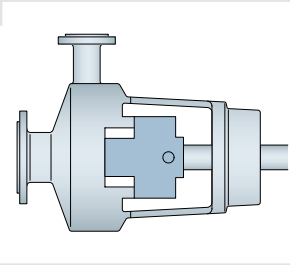

Tapped connections for the purchaser's use e. g., for future use of buffer gas.

Plan 74

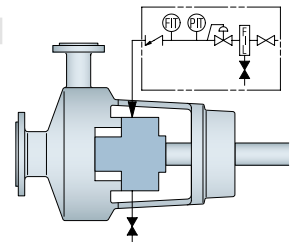

Externally supplied barrier gas for arrangement 3 dual pressurized non-contacting gas seals (3NC-FB, 3NC-BB, 3NC-FF).

Plan 75

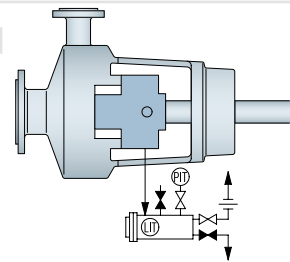

A containment seal chamber leakage collection system for condensing or mixed phase leakage on arrangement 2 unpressurized seals with containment seals (2CW-CS and 2NC-CS).

Plan 76

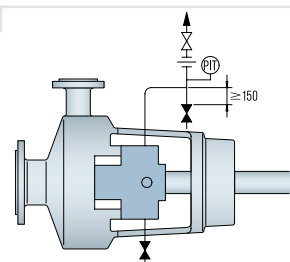

A containment seal chamber drain for non-condensing leakage on arrangement 2 unpressurized seals with containment seals (2CW-CS and 2NC-CS). Used if the pumped fluid does not condense at ambient temperatures.

Equipment symbols

	Bladder accumulator		Valve, normally open
	Cyclone separator		Valve, normally closed
	Filter, coalescing		Valve, check
	Flow orifice		Valve, needle
	Seal cooler		Valve, pressure control
	Strainer, Y		Valve, pressure relief

Technical information

Atmospheric side

Plan 51

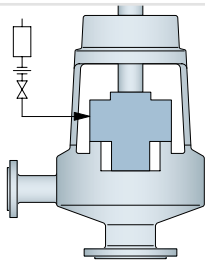

Reservoir providing a dead-ended blanket for fluid to the quench connection of the gland plate. Only recommended for vertical pumps.

Plan 65A

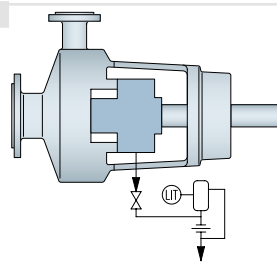

Atmospheric leakage collection and alarm system for condensing leakage. Failure of the seal will be detected by an excessive flow rate into the leakage collection system.

Plan 66B

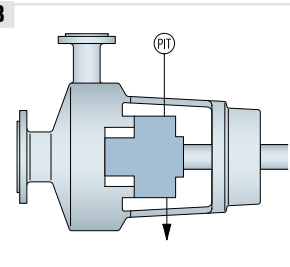

An orifice plug in the drain port minimizes the seal leakage leaving the seal gland and allows for detection of a seal failure by an alarm of the monitoring pressure transmitter.

Plan 62

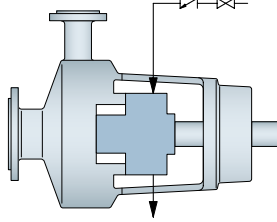

Quench stream from an external source to the atmospheric side of the seal faces. The quench stream can be low pressure steam, nitrogen or clean water.

Plan 65B

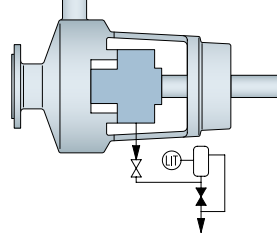

Atmospheric leakage collection and detection system for condensing leakage. Failure of the seal will be detected by a cumulative leakage into the system.

Plan 61

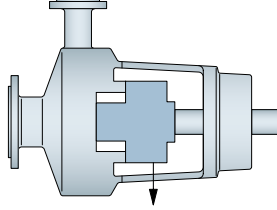

Tapped and plugged atmospheric-side connections for purchaser's use.

Plan 66A

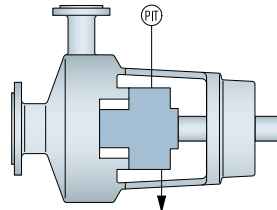

Throttle bushings in the seal gland minimize the seal leakage leaving the seal gland and allow for detection of a seal failure by an alarm of the monitoring pressure transmitter.

Plan 99

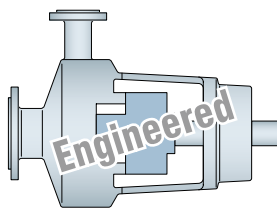

Engineered piping plan not defined by other existing plans.

Seal coding system according to API 682 4th edition

Mechanical seal			Design options			Size	Plans																																																				
Category	Arrangement	Type	Containment device	Secondary seal material	Face material	Shaft size	Piping plan																																																				
1 2 3	1 2 3	A B C Dual seal with different seal types in the inner and outer position: Inner type / Outer type e.g. C/B	P: Plain gland for Arrangement 2 and 3 L: Floating throttle bushing for Arrangement 1, Category 1, 2, 3 F: Fixed throttle bushing for Arrangement 1, Category 1 C: Containment seal for 2CW-CS, 2NC-CS S: Floating, segmented carbon bushing X: Specified separately	F: FKM G: PTFE H: Nitrile I: FFKM R: Flexible graphite X: Unspecified Dual seal with different secondary seal materials at the inner and outer position: Inner material/Outer material e. g. I/F	M: Carbon/Nickel bounded tungsten N: Carbon/RBSiC O: RBSiC/Nickel bounded tungsten P: RBSiC/RBSiC Q: SSiC/SSiC R: Carbon/SSiC S: Graphite loaded RBSiC/RBSiC T: Graphite loaded SSiC/SSiC X: Unspecified Dual seal with different face materials at the inner and outer position: Inner material/Outer material e. g. P/N	Three digits, rounded up to the next whole millimeter Examples: 25.00 mm: 025 25.25 mm: 026 25.90 mm: 026 XXX: Unspecified	Listed in numerical order, separated by a forward slash <table border="1"> <tr><td>01</td><td>51</td><td>61</td><td>99</td></tr> <tr><td>02</td><td>52</td><td>62</td><td></td></tr> <tr><td>03</td><td>53A</td><td>65A</td><td></td></tr> <tr><td>11</td><td>53B</td><td>65B</td><td></td></tr> <tr><td>12</td><td>53C</td><td>66A</td><td></td></tr> <tr><td>13</td><td>54</td><td>66B</td><td></td></tr> <tr><td>14</td><td>55</td><td></td><td></td></tr> <tr><td>21</td><td>71</td><td></td><td></td></tr> <tr><td>22</td><td>72</td><td></td><td></td></tr> <tr><td>23</td><td>74</td><td></td><td></td></tr> <tr><td>31</td><td>75</td><td></td><td></td></tr> <tr><td>32</td><td>76</td><td></td><td></td></tr> <tr><td>41</td><td></td><td></td><td></td></tr> </table>	01	51	61	99	02	52	62		03	53A	65A		11	53B	65B		12	53C	66A		13	54	66B		14	55			21	71			22	72			23	74			31	75			32	76			41			
01	51	61	99																																																								
02	52	62																																																									
03	53A	65A																																																									
11	53B	65B																																																									
12	53C	66A																																																									
13	54	66B																																																									
14	55																																																										
21	71																																																										
22	72																																																										
23	74																																																										
31	75																																																										
32	76																																																										
41																																																											

Example

Mechanical seal			Design options			Size	Plans
Category	Arrangement	Type	Containment device	Secondary seal material	Face material	Shaft size	Piping plan
2	2	A	X: Specified separately	I: FFKM (Inner position) F: FKM (Outer position)	N: Carbon /RBSiC	080	11/52/62

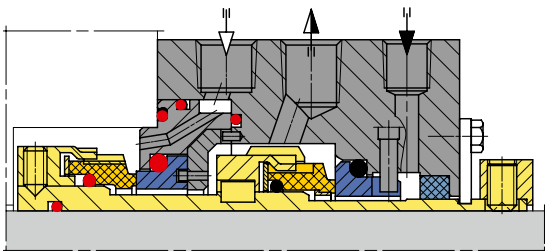

Seal designation: 22A-XI/FN-080-11/52/62



Mechanical seal selection by media

The recommendations in the media tables are based on the "typical case" of a seal for a horizontal centrifugal pump. Other types of machine, installation conditions, modes of operation, designer's, manufacturer's and operator's specifications, local regulations and so on can result in a different choice of mechanical seal.

For complex sealing duties it is always advisable for the user to consult with our specialist engineers.

Introduction	24
Media tables	27

Short legend:
Fold-out page at back cover

Mechanical seal selection by media

The recommendations in the media tables are based on the "typical case" of a seal for a horizontal centrifugal pump. Other types of machine, installation conditions, modes of operation, designer's, manufacturer's and operator's specifications, local regulations and so on can result in a different choice of mechanical seal. For complex sealing duties it is always advisable for the user to consult with our specialist engineer. Explanations to columns 1 to 16:

Column 1: Media designation

Designations of materials to be sealed comply as far as possible with IUPAC rules (IUPAC = International Union of Pure and Applied Chemistry). Where a material has several commonly used designations and common names, it is listed in accordance with IUPAC rules with cross-referencing of its other names. Designations are listed in alphabetical order.

Column 2: Notes on the media

- G** = mixture/group (compound)
The media is a mixture of various isomers of one substance or it is a group of substances having close chemical ties.
- N** = natural product
The medium is a natural product or the refined form of a natural product with changing proportions of its various constituents.
- ®** = trade mark
The constituents of the media or their proportions in the medium are unknown or are not known exactly.
- S** = collective term
The generalized mechanical seal recommendation is no more than a pointer to a suitable mechanical seal.
- TA** = TA-Luft relevant medium.
The requirements of the TA-Luft air quality control directive have to be considered.
- V** = impurities
The medium contains large quantities of impurities due to the peculiarities of the process.

Column 3: Concentration

- = The media normally occurs in pure form and (as in the case of gases and other media requiring a double mechanical seal) - the concentration has no bearing on the mechanical seal selection.
- < 10 = concentration less than 10 % by weight.
- ~ 10 = The designation in column 1 is the common name for approximately 10 % aqueous solution.
- F10 = A solids content of up to 10 % by weight.
- L = Solution of defined composition
- < L = Unsaturated solution
- > L = Supersaturated solution
- Sch = Melt
- Sus = Suspension of defined composition

Column 4: Temperature

- < 100 = less than 100 °C
- < F = minimum of 10 °C above solidifying temperature
- > K = minimum of 10 °C above crystallization temperature

- < Kp = For aqueous solutions: Up to approximately 10 °C below boiling point at atmospheric pressure.
For gases: 20 °C below boiling point of the liquefied gas; at the same time, the sealing pressure must be a minimum 3 bar higher than the vapor pressure.
For other media: Up to approx. 20 °C below boiling point at 1 bar (but no higher than 400 °C)
- > Pp = minimum 10 °C above pour point
- TG = Up to the operating temperature limit of the mechanical seal's materials in contact with the product.

Column 5: Arrangement of shaft seal

Designation in accordance with ISO 5199, Appendix E; explanations are modified in parts.

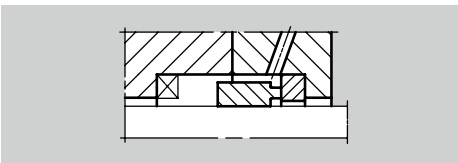

Single mechanical seal arrangement

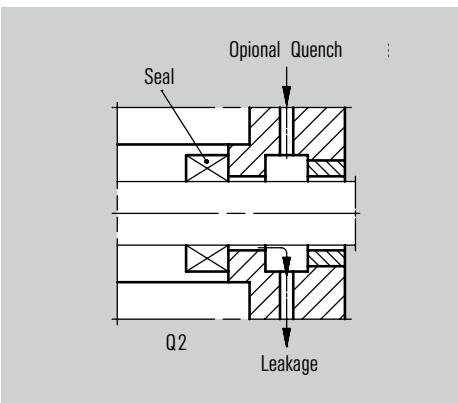

Quench arrangement

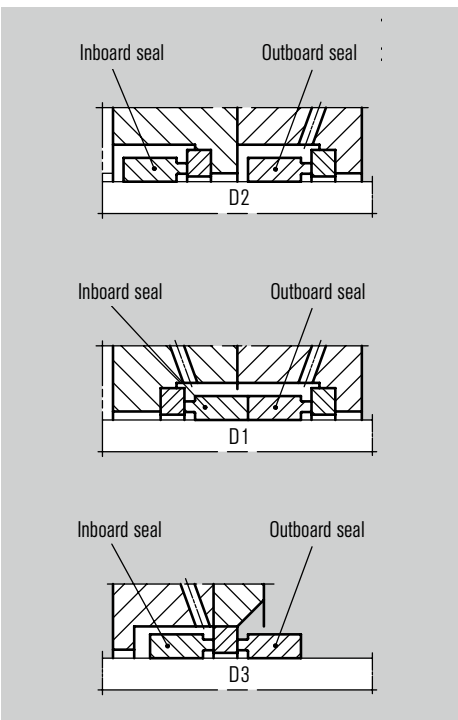

Double mechanical seal arrangement

- S** = Single mechanical seal
These seals can be unbalanced, balanced, with or without circulation or flushing of seal faces, with or without throttle bushing.
- D** = Double mechanical seal
Either one of the seals can be unbalanced or balanced on its own, or both together.
- Q** = Quench arrangement for single and double mechanical seals.
Liquids are sealed by lip seal, gaseous media by.

Column 6: Auxiliary piping plans

Basic arrangements and alternatives see API 682/ISO 21049.

Column 7: Additional measures

- D** = Steam quench
- (H), H** = Heating (where necessary) of the seal housing, seal cover, buffer medium
- kD** = Conical stuffing box
- SS** = Splash guard necessary. Leakage pipe-away recommended.
- SW** = Regular replacement of buffer medium necessary.
Alternative is a constant through flow of buffer medium.
- QW** = Regular replacement of quench medium necessary.
An alternative is a constant through flow of quench medium; approximately 0.25 l/min is recommended.
- ThE** = Thermal buffer

Column 8: Mechanical seal type

In the case of double or tandem mechanical seals, the recommendation applies to the mechanical seal inboard. The choice of the outboard seal is dictated by the buffer/-quench medium.

- 1** = Mechanical seal having O-Ring secondary seals; unbalanced or balanced; rotating spring in contact with the product, e.g. M3N, M7N, H7N
- 2** = Mechanical seal having O-Ring secondary seals; unbalanced or balanced; rotating springs not in contact with the product, e.g. HJ ...
- 3** = Mechanical seal having O-Ring secondary seals; unbalanced or balanced; stationary springs not in contact with the product, e.g. HR ...
- 4** = Same as 3 but no metal parts in the product; e.g. HR31/d_H - G9
- 5** = Mechanical seal with elastomer bellows; bellows as, MG ...
- 6** = Mechanical seal with metal bellows; such as, MFL
- X** = Special design e.g. a modified MR-D

Column 9: Materials of construction

for inboard mechanical seals. For an explanation of the material codes and their indices, consult the material key.

Column 10: Hazard warnings and reasons for recommending a double mechanical seal or quench.

When compiling these seal selections and material recommendations, it was generally assumed that the machine in question is located in a sheltered building frequented occasionally or continually by persons coming into contact with liquid or vapor leakage of medium from all types of sealing points. As such, considerations of health and environmental protection had a strong bearing on the choice of seal category.

"Health hazard" and "Ignition/Explosion" can lose much of their significance if the machine is installed in the open or in areas rarely frequented by people and ringed with warning signs. If no mention is made to either of the reasons 1 to 5 for recommending a double mechanical seal or a single mechanical seal with quench, it is acceptable to use a single mechanical seal.

The decision in favor of a single mechanical seal must be taken by the user of the machine or the contractor. As he is the only one to know all conditions and regulations relating to the process and to assess the risks.

Letters in column 10: Health hazard warnings



T = Toxic

Media which in low quantities cause death or acute or chronic damage to health when inhaled, swallowed or absorbed via the skin.

T+ = Very toxic

Media which in very low quantities cause death or acute or chronic damage to health when inhaled, swallowed or absorbed via the skin.



Xn = Harmful

Media which may cause death or acute or chronic damage to health when inhaled, swallowed or absorbed via the skin.



Xi = Irritant

Non-corrosive media which, through immediate, prolonged or repeated contact with the skin or mucous membrane, may cause inflammation.

C = Corrosive

Media which may, on contact with living tissues, destroy them.

Carcinogenic:

Substances and preparations which, if they are inhaled or ingested or if they penetrate the skin, may induce cancer or increase its incidence.

Mutagenic:

Substances and preparations which, if they are inhaled or ingested or if they penetrate the skin, may induce heritable genetic defects or increase their incidence. Labeling of media with carcinogenic or mutagenic effect:

R 40: Limited evidence of a carcinogenic effect

R 45: May cause cancer

R 46: May cause heritable genetic damage

R 49: May cause cancer by inhalation

Toxic for reproduction:

Substances and preparations which, if they are inhaled or ingested or if they penetrate the skin, may produce, or increase the incidence of, non-heritable adverse effects in the progeny and/or an impairment of male or female reproductive functions or capacity. Labeling of media with a toxic effect for reproduction:

R 60: May impair fertility

R 62: Possible risk of impaired fertility

R 63: Possible risk of harm to the unborn child

Technical grounds and environmental protection

1 = Vapor pressure/gas

At normal working temperatures, the medium has a vapor pressure of > 1 bar. If the working temperature lies below boiling point (column 15) or if the sealing pressure lies clearly above the vapor pressure, a single mechanical seal may be used with consideration of the duty details.

2 = Corrosion

The medium attacks all standard metals. Mechanical seals with no metal parts on product side must therefore be used.

3 = Exclusion of air

If the medium contacts or mixes with the atmosphere, it forms an explosive or reacts with a damaging effect on the environment, the medium itself and the machine and mechanical seal.

4 = Lubricating properties

Under normal conditions, the medium has such poor lubricity that a single mechanical seal is at risk from dry running.

5 = Icing

Normally the medium is conveyed at temperature below 0 °C. Without auxiliary equipment, the proper functioning of a single mechanical seal is at risk from freezing atmospheric moisture.

6 = Leakage

Absorbed and/or flushed away by the quench, or prevented by a double mechanical seal necessary.



F = Highly flammable

Media which may become hot and finally catch fire in contact with air at ambient temperature without any application of energy, or solid media which may readily catch fire after brief contact with a source of ignition and which continue to burn or to be consumed after removal of the source of ignition, or liquid media having a very low flash-point, or media which, in contact with water or damp air, evolve extremely flammable gases in dangerous quantities.

F+ = Extremely flammable

Liquid media having an extremely low flash-point and a low boiling-point and gaseous media which are flammable in contact with air at ambient temperature and pressure



O = Oxidizing

Media which give rise to a highly exothermic reaction in contact with other substances, particularly flammable substances.



E = Explosive

Solid, liquid, pasty or gelatinous media which may also react exothermically without atmospheric oxygen thereby quickly evolving gases, and which, under defined test conditions, detonate, quickly deflagrate or upon heating explode when partially confined.



N = Dangerous for the environment

Media which, when they enter the environment, would or could present an immediate or delayed danger for one or more components of the environment. (The hazard symbols are according to the EU directive 67/548/EEC, "Classification, packaging and labeling of dangerous substances" of June 1967, status April 2004)

U = Insufficient information

The medium designation is imprecise or the available information on the medium is insufficient to assess the serviceability of a single mechanical seal.

Mechanical seal selection by media

Column 11: TLV

The values quoted in $\text{ml/m}^3 = \text{ppm}$ (parts per million) are taken from Bulletin 30 published by the Senate Commission for Testing Hazardous Materials: "Threshold Limit Values and Biological Material Tolerances".

Additional symbols:

mg: TLVs are quoted in mg/m^3 instead of ppm
#, e.g. # 0.5 for barium ...: 0.5 mg/m^3 , calculated as Ba

* "According to the current level of knowledge, the action of this substance constitutes a distinct carcinogenic hazard for humans. No concentration values are given for this substance in the list because it is still impossible to quote any concentration as being safe. With some of these substances, there is even a great risk from absorption through healthy skin. If the use of such substances is unavoidable for technical reasons, special safety and monitoring measures must be taken."

The seal selection takes account of the TLV as follows:

- TLV < 5 ppm or*: Use of a double mechanical seal is generally recommended, but see paragraphs 2 + 3 of the introductory note on column 10.
- TLV ≥ 5 , ≤ 25 ppm: A double mechanical seal or a single mechanical seal with quench is recommended. If column 10 contains no further grounds other than "health hazard" for choosing a tandem or double mechanical seal, a single mechanical seal can be used, provided other measures rule out all risks to humans.

Column 12: Normal condition

of the pure medium at 20 °C and 1.013 bar:

ga = gaseous
fe = solid; no further details available
fl = liquid
kr = crystalline
pa = viscous

This column contains the following notes on aspects of sealing:

ga requires a double mechanical seal in most cases. If the pressure to be sealed lies distinctly above the vapor pressure at working temperature, a single mechanical seal with or without quench can be used under certain circumstances.

fl indicates the use of single mechanical seal, but other influencing factors such as the working temperature (vapor pressure at pumping temperature, health hazard, risk of explosion or corrosion can necessitate a tandem or double mechanical seal.

fe, kr indicates that the medium must be molten (e.g. sulphur, DMT), dissolved (e.g. salts) or suspended (e.g. limestone or gypsum in water), otherwise it cannot be pumped or stirred.

Column 13: Melting point

(= Fusion point F) in °C If there are unequal values for the solidifying point (setting temperature) and the melting point (liquefying temperature), or different values or modifications, the higher value is always quoted. For some mixtures of media, solidification ranges or pour points are quoted. With fusion points above room temperature and/or working temperatures close to fusion point, it is necessary to check (with due consideration of the other operating conditions such as intermittent mode, full stand-by pump) whether the machine or at least the seal housing requires heating.

Additional signs:

K ...: Crystallization at temperatures below ... °C
S ...: Sublimation at ... °C

If there is an additional %-figure, the quoted temperature applies to the ... % aqueous solution.

Column 14: Boiling point

Boiling point of the medium in °C under normal pressure (1.013 bar). Different reference pressures are marked. If the working temperature is close to or above boiling point, the seal selection and material recommendation must be checked.

Additional signs:

A ...: The azeotrope boils at ... °C
Z ...: Decomposition at ... °C

(...): Reference pressure in mbar

If there is an additional %-figure, the quoted temperature applies to the ... % aqueous solution.

Column 15: Density

For media that are liquid or solid under normal conditions, the density is quoted – where known – in g/cm^3 at 20 °C. Different reference temperatures are indicated.

For gases there is only an indication whether they are heavier than air (+) or lighter than air (-). This is also a pointer to their behavior in the event of leakage: sinking, rising or self-dissolving.

Additional signs:

(...): Reference temperature in °C
A ...: The quote density applies to the azeotrope at ... % weight ...
%: Density of ... % aqueous solution

Mechanical seal selection by media

Media				Mechanical Seal									Additional information on the medium						
Code of materials and legend see inside of back cover. Please observe the note on page 1.	Chemical formula	Remark	Concentration %	Temp. °C	Arrangement	Auxil. piping	Addit. measures	Seal type	Materials to EN 12756					Hazard warnings	TLV-value	Normal condition	Melting temperature °C	Boiling point °C	Density g/cm ³
									1	2	3	4	5						
									Seal face	Seal face	Sec. seal	Spring	Others						
1	2	3	4	5	6	7	8	10	11	12	13	14	15						
Amidosulfuric acid (Amidosulfonic-, Sulfamidic, Sulfamic acid)			<L	<Kp,>K	S	11		1	Q ₁ (V)	B	M ₁	G	G	Xi			205(Z)	2,1	
Amines (not specified)		S	-	<Kp	S,Q	62		1	Q ₁ (V)	B	M ₂	G	G	U		fl			
Aminoethanols: 1-Aminoethanol 2-Aminoethanol (Ethanolamine)	(CH ₂) ₂ NH ₂ OH (CH ₂) ₂ NH ₂ OH		<L	<Kp,>K	S	11		1	Q ₁ (V)	B	M ₂	G	G			kr	95...99	110	
Aminosulfonic acid		TA	-	<Kp	D	53A		1	Q ₁ (V)	B	M ₂	G	G	Xn,C	3	fl	10	171	
Ammonia	NH ₃		-	<40	D	53A		1	Q ₁ (S)	B	E	G	G	T,C,1,N	50	ga	-78	-33	
Ammonia aqu. solutions: Caustic ammonia Spirits of salmiac	NH ₄ OH NH ₄ OH		~29	<Kp	D	53A		1	Q ₁ (S)	B	M ₂	G	G	C,N		fl		0,9	
Ammonium acetate	H ₃ CCOONH ₄ H ₃ CCOONH ₄		<L	<60,>K	S	11		1	Q ₁ (S)	B	E	G	G			fe	113 (Z90 °C)	1,171	
Ammonium alum	NH ₄ Al(SO ₄) ₂ *12H ₂ O		<L	<60,>K	S	11		1	Q ₁ (V)	B	V	G	G			kr	109	1,64	
Ammonium bromide	NH ₄ Br		<L	<Kp,>K	S,Q	11		1	Q ₁ (V)	B	M ₁	G	G	Xi,6		kr	452(S)	2,55	
Ammonium carbamate → Urea																			
Ammonium carbonate	(NH ₄) ₂ CO ₃		<L	<60,>K	S	11		1	Q ₁ (V)	B	E	G	G	Xn		kr			
Ammonium chloride (Salmiac)	NH ₄ Cl NH ₄ Cl NH ₄ Cl NH ₄ Cl		<L	<30,>K	S	11		1	Q ₁ (V)	B	E	G	G	Xn,Xi		kr		338(S)	
			<L	<60	S	11		5	Q ₁	Q ₁	E	M	M					1,531	
			<L	<Kp	D	53A		1	Q ₁ (V)	B	M ₂	G	G	2					
			>L	<Kp	S	01		4	Q ₁	Q ₁	M ₂	M	G						
Ammonium fluorides: Ammonium hydrogen fluoride Neutral ammonium fluoride	(NH ₄)HF ₂ NH ₄ F		<L	>Kp	D	54		1	Q ₁	B	M ₂	G	G	T,C,2		kr	126	238(Z)	
			<L	<Kp	D	54		1	Q ₁	B	M ₂	G	G	T,2		kr	160	1,0	
Ammonium hydrogen carbonate	(NH ₄)HCO ₃		<L	<Kp,>K	S	11		1	Q ₁ (V)	B	E	G	G	Xn		kr	106 (Z60 °C)	1,58	
Ammonium hydroxide → Ammonia aqu. Solutions																			
Ammonium nitrate	NH ₄ NO ₃		<L	<Kp,>K	S,Q	62	D	1	Q ₁ (V)	B	E	G	G	3,0		kr	170	1,73	
Ammonium oxalate monohydrate	(COONH ₄) ₂ *H ₂ O		<10	<Kp	D	53A		1	Q ₁	Q ₁	M ₂	G	G	Xn,3		kr	70(Z)	1,5	
Ammonium persulfate (Ammonium peroxodisulfate)	(NH ₄) ₂ S ₂ O ₈		<L	<Kp,>K	S,Q	62		1	Q ₁	Q	M ₂	G	G	Xn,Xi,3,0		kr	120(Z)	1,98	
Ammonium phosphate, secondary	(NH ₄) ₂ HPO ₄		<L	<60,>K	S	11		1	Q ₁ (V)	B	E	G	G			kr	155(Z)	1,619	
Ammonium sulfate	(NH ₄) ₂ SO ₄		<L	<Kp,>K	S	11		1	Q ₁ (V)	B	E	G	G			kr	235...280(Z)	1,77	
Ammonium thiocyanate (Ammonium rhodanide)	NH ₄ SCN	TA	<L	<Kp,>K	S	11		1	Q ₁ (V)	B	M ₁	G	G	Xn		kr	149	170(Z)	
Amyl acetate → Acetic acid pentyl esters																			
Amyl alcohols → Pentanols																			
Aniline dyes		S	-	<80	S	11		1	Q ₁ (S)	B	M ₂	G	G	U		fl			
Aniline hydrochloride (aniline salt)	C ₆ H ₅ NH ₃ Cl	TA	<L	<Kp	D	53A		1	Q ₁ (V)	B	M ₁	G	G	T,Xi,R40,2,3,N		kr	198	245	
Aniline, aniline oil	C ₆ H ₇ N	TA	-	TG	D	53A		1	Q ₁ (S)	B	M ₂	G	G	T,Xi,R40,3,N	2	fl	-6	184	
Anthracene	C ₁₄ H ₁₀	TA	Sch	>F<Kp	S,Q	62	H,D	6	A	Q ₁	G	M ₆	T4	Xn,6		kr	217	342	
Anthracene oil		TA,G	Sch	>F<Kp	S,Q	62	H,D	6	A	Q ₁	G	M ₆	T4	T,R45,6		kr			
Antichlor → Sodium thiosulfate																			
Apple juice, sauce, cider, wine		N	-	<Kp	S	11		1	Q ₁ (S)	B	P	G	G						
Arcton → Refrigerants																			
Argon	Ar		-	>-20	D	53A		1	Q ₁ (S)	B	M ₁	G	G	1		ga	-189	-186	
Aromatic hydrocarbons → BTX																			
Arrack			-	<60	S	11		1	Q ₁ (S)	B	E	G	G			fl			
Arsenic acid	H ₃ AsO ₄	TA	-	<Kp	D	53A	SW	1	Q ₁	Q ₁	M ₁	G	G	T,R45,2,N	*	fl	35,5	120	
Asphalts (molten)		N	-	<120	S	02	H	1	Q ₁ (S)	B	V	G	G			fe	70...150	>370	
			-	<200	S	01	H	1	Q ₁ (S)	B	M ₁	G	G					1,0...1,2	
			-	>200	S,Q	62	H,D	6	A	Q ₁	G	M ₆	T4	6					
ASTM test oils No. 1 to 4			-	<100	S	11		1	Q ₁ (S)	B	V	G	G	U		fl			
Aviation petrol, av. gasoline		TA,G	-	<Kp	S	11		1	Q ₁ (S)	B	V	G	G	T,Xn,R45		fl	bis <-58	40...160	

Media				Mechanical Seal										Additional information on the medium					
Code of materials and legend see inside of back cover. Please observe the note on page 1.	Chemical formula	Remark	Concentration %	Temp. °C	Arrangement	Auxil. piping	Addit. measures	Seal type	Materials to EN 12756					Hazard warnings	TLV-value	Normal condition	Melting temperature °C	Boiling point °C	Density g/cm ³
									1	2	3	4	5						
									Seal face	Seal face	Sec. seal	Spring	Others						
1	2	3	4	5	6	7	8	9	10	11	12	13	14	15					

B																			
Barium chloride	BaCl ₂		<L	<60	S,Q	62		1	Q ₁ (V)	B	V	G	G	T,Xn,6	#0,5	kr	960	1560	3,86
Barium chromate suspension	BaCrO ₄		<10	<60	S,Q	62	QW	5	Q ₁	Q ₁	V	G	G	Xn,6	#0,5	kr			4,5
Barium hydroxide	Ba(OH) ₂		<L	<60	S,Q	62	QW	1	Q ₁ (V)	B	E	G	G	C,6	#0,5	kr			4,5
	Ba(OH) ₂		<L	<10	S,Q	62	QW	5	Q ₁	Q ₁	E	G	G	C,6					
Barium nitrate	Ba(NO ₃) ₂		<L	<80	S,Q	62	QW	1	Q ₁ (V)	B	V	G	G	Xn,6,0	#0,5	kr	593	600(Z)	3,24
	Ba(NO ₃) ₂		<20	<80	S,Q	62	QW	5	Q ₁	Q ₁	V	G	G	Xn,6,0					
Battery acid → Sulfuric acid																			
Beer		N	-	<80	S	01		1	Q ₁	Q ₁	V	G	G			fl			
Beer yeast, -wort, -mash		N	-	<80	S	01		1	Q ₁	Q ₁	V	G	G			fl			
Beet sugar → Saccharose																			
Benfield solution (30 % K ₂ CO ₃ + 3 % DEA + H ₂ O + CO ₂)		G	-	<110	S	32		X	Q ₃₂	Q ₃	E	G	G	Xi			~60(K)		1,2...1,3
Benzene	C ₆ H ₆	TA	-	<Kp	D	53A		1	Q ₁ (S)	B	M ₁	G	G	T,Xn,Xi,R45,R46,F,6	*	fl		80	0,879
Benzoic acid	C ₇ H ₆ O ₂		<L	<100	S	11		1	Q ₁ (S)	B	V	G	G	Xn		kr	122	249	1,266
	C ₇ H ₆ O ₂		<L	<100	S	11		2	Q ₁	Q ₁	V	G	G						
	C ₇ H ₆ O ₂		-	>F<200	S	02	(H)	3	Q ₁	Q ₁	M ₁	M	G						
Benzotrichloride	C ₇ H ₅ Cl ₃	TA	-	<200	D	53A		1	Q ₁	Q ₁	M ₁	G	G	T,Xn,Xi,R45,2		fl	-4,8	221	1,38
Benzotrifluoride	C ₇ H ₅ F ₃	TA	-	<60	S,Q	62		1	Q ₁ (V)	B	V	G	G	6,F,N		fl	-29	104	1,189
Benzyl alcohol	C ₇ H ₈ O		-	<100	S	11		1	Q ₁ (S)	B	M ₂	G	G	Xn		fl	-15	205	1,045
	C ₇ H ₈ O		-	<30	S	11		1	Q ₁ (S)	B	V	G	G						
Benzyl butyl phthalate (BBP) → Phthalic acid esters																			
Biphenyl	C ₁₂ H ₁₀	TA	-	>75<Kp	D	53A		6	A	Q ₁	G	M ₆	T ₄	Xi,3,N	0,2	kr	69	255	1,04
Bitumen		G	-	>F<200	S	01	H	1	Q ₁ (S)	B	M ₁	G	G			fe		>370	0,95...1,1
			-	<200	S	01	H	6	A	Q ₁	G	M ₆	T ₄						
Black liquor → Digester liquor, basic																			
Blast furnace gas			-	<200	D	53A		1	Q ₁ (V)	B	M ₁	G	G	1		ga			
Bleaching earth suspension		G	<10	<100	S	11		5	Q ₁	Q ₁	V	G	G			fe			
Bleaching lye → Sodium hypochlorite, → Calcium hypochlorite																			
Blood		N	-	<60	S	11		1	Q ₁ (S)	B	P	G	G			fl			
Boiler feed water → Water																			
Bone fats		N	-	<Kp	S	11		1	Q ₁ (S)	B	V	G	G			fl			
Borax (Disodium tetraborate)	Na ₂ B ₄ O ₇ ·10H ₂ O		<L	<60	S	11		1	Q ₁ (V)	B	P	G	G	Xn,R62		kr	75	1575(Z)	1,72
Boric acid	B(OH) ₃		<L	<60	S,Q	62		1	Q ₁ (V)	B	V	G	G	T,6		kr	169(Z)		1,52
Boron trichloride (Trichloroborane)	BCl ₃		-	TG	D	53A		1	Q ₁ (V)	B	M ₁	G	G	T+,C,1		ga	-107	12,5	1,43 (0°C)
Boron trifluoride (Trifluoroborane)	BF ₃		-	TG	D	53A		1	Q ₁	Q ₁	M ₁	G	G	T+,C,1	1	ga	-127	-100	(+)
Brackish water → Water																			
Bread dough		N			D	53A		1	Q ₁ (S)	B	V	G	G						
Brine → Sodium chloride																			
Bromic acid	HBrO ₃		-	<Kp	D	53A		1	Q ₁	Q ₁	M ₁	G	G	T,C,2,6		fl			
Bromine	Br ₂		-	<Kp	D	53A		1	Q ₁	Q ₁	M ₁	G	G	T+,C,2,3,N	0,1	fl	-7	58	3,12
Bromine, aqueous (aqueous solution of bromine)	Br ₂		<L	<Kp	D	53A		1	Q ₁	Q ₁	M ₁	G	G	T+,C,3,6,N		fl			
BTX (benzene-toluene- xylene mixture)		TA	-	<Kp	S,Q	62		1	Q ₁ (S)	B	M ₁	G	G	T,Xn,Xi,R45,R46,R63,6,F	*	fl			
Bunker oil and fuel		TA/N	-	120	S	11		1	Q ₁ (S)	B	V	G	G	T,R45		fl			
1,3-Butadiene		TA	-	TG	D	53A		1	Q ₁ (S)	B	V	G	G	T,R45,R46,1,3,6,F+	*	ga	-109	-4,5	(+)
Butanal → Butyraldehyde																			
Butane:	Isobutane (2-methyl propane) n-Butane	C ₄ H ₁₀	TA	-	<Kp	S,Q	62	1	Q ₁ (S)	A	V	G	G	4,F+	1000	ga	-159	-12	(-)
		C ₄ H ₁₀	TA	-	<Kp	S,Q	62	1	Q ₁ (S)	A	V	G	G	4,F+	1000	ga	-135	-1	(-)
Butanediols (Butylene glycols):	1,2-Butanediol 1,3-Butanediol 1,4-Butanediol 2,3-Butanediol	C ₄ H ₁₀ O ₂	-	<Kp	S	11		1	Q ₁ (S)	B	M ₁	G	G			fl	-114	192	1,019
		C ₄ H ₁₀ O ₂	-	<Kp	S	11		1	Q ₁ (S)	B	M ₁	G	G			fl	<-50	207	1,005
		C ₄ H ₁₀ O ₂	-	<200	S	11		1	Q ₁ (S)	B	M ₁	G	G	Xn		fl	20	230	1,020
		C ₄ H ₁₀ O ₂	-	<Kp	S	11		1	Q ₁ (S)	B	M ₁	G	G			fl	19	182	1,033
Butanic acid → Butyric acid																			

Mechanical seal selection by media

Media				Mechanical Seal										Additional information on the medium					
Code of materials and legend see inside of back cover. Please observe the note on page 1.	Chemical formula	Remark	Concentration %	Temp. °C	Arrangement	Auxil. piping	Addit. measures	Seal type	Materials to EN 12756					Hazard warnings	TLV-value	Normal condition	Melting temperature °C	Boiling point °C	Density g/cm³
									1	2	3	4	5						
									Seal face	Seal face	Sec. seal	Spring	Others						
1	2	3	4	5	6	7	8	9	10	11	12	13	14	15					
Butanol:																			
1-Butanol	C ₄ H ₁₀ O		-	<60	S	11		1	Q ₁ (S)	B	E	G	G	Xn,Xi	100	fl	-90	118	0,813
2-Butanol	C ₄ H ₁₀ O	TA	-	<80	S	11		1	Q ₁ (S)	B	E	G	G	Xi	100	fl	-115	100	0,811
Isobutanol	C ₄ H ₁₀ O		-	<60	S	11		1	Q ₁ (S)	B	E	G	G	Xi	100	fl	-108	108	0,806
tert. Butyl alcohol	C ₄ H ₁₀ O	TA	-	<60,<K	S	11		1	Q ₁	B	E	G	G	Xn,F	100	kr	26	82	0,776
Butanone (Ethyl methyl ketone)	C ₄ H ₈ O		-	<Kp	S	11		1	Q ₁	B	M ₂	G	G	7	200	fl	-86	80	0,805
Butene (Butylene):																			
1-Butene	C ₄ H ₈	TA	-	<Kp	S,Q	62		6	A	Q ₁	U ₁	T ₁	G ₁	4,5,F+		ga	-185	-7	(-)
cis-2-Butene	C ₄ H ₈	TA	-	<Kp	S,Q	62		6	A	Q ₁	U ₁	T ₁	G ₁	4,5,F+		ga	-139	3	(-)
Isobutene	C ₄ H ₈	TA	-	<Kp	S,Q	62		6	A	Q ₁	U ₁	T ₁	G ₁	4,5,F+		ga	-140	-7	(-)
trans-2-Butene	C ₄ H ₈	TA	-	<Kp	S,Q	62		6	A	Q ₁	U ₁	T ₁	G ₁	4,5,F+		ga	-105	1	(-)
Butter		N	-	<80	S	11		1	Q ₁ (S)	B	P	G	G			pa			
Buttermilk		N	-	<80	S	11		1	Q ₁ (S)	B	P	G	G			fl			
Butyl acetate → Acetic acid esters																			
Butyl alcohol → Butanol																			
Butylamines:																			
1-Butylamine (1-Aminobutane)	C ₄ H ₁₁ N	TA	-	<Kp	S,Q	62		1	Q ₁	B	M ₁	G	G	Xn,C,F,3,6	5	fl	-50	78	0,733
Isobutylamine (2-Methyl-1-propylamine)	C ₄ H ₁₁ N	TA	-	<Kp	S,Q	62		1	Q ₁	B	M ₁	G	G	C,F,3,6	5	fl	-85	66	0,736
sec. Butylamine (2-Aminobutane)	C ₄ H ₁₁ N	TA	-	<Kp	S,Q	62		1	Q ₁	B	M ₁	G	G	Xn,C,F,3,6,N	5	fl	-104	63	0,724
Butylene → Butene																			
Butyraldehydes:																			
Butyraldehyde (Butanal)	C ₄ H ₈ O		-	<Kp	S,Q	62		1	Q ₁ (V)	B	M ₂	G	G	3,6,F		fl	-99	75	0,802
Isobutyraldehyde (2-Methylpropanal)	C ₄ H ₈ O		-	<Kp	S,Q	62		1	Q ₁ (V)	B	M ₂	G	G	3,6,F		fl	-66	64	0,794
Butyrates → Butyric acid esters																			
Butyric acid:																			
Isobutyric acid	C ₄ H ₈ O ₂		-	<60	S	11		1	Q ₁ (S)	B	M ₁	G	G	C		fl	-47	155	0,950
n-Butyric acid	C ₄ H ₈ O ₂		-	<60	S	11		1	Q ₁ (S)	B	M ₁	G	G	C		fl	-6	163	0,959
Butyric acid esters (Butyrates)		S	-	<100	S	11		1	Q ₁ (S)	B	M ₂	G	G	U		fl	<0	<100	
C																			
Cable sealing compounds		S	-	<220	S	02	H	6	A	Q ₁	U ₁	M ₆	G ₁						
		S	-	>220	S	02	H	6	A	Q ₁	U ₁	M ₆	T ₄						
Calcium acetate	Ca(DCOCH ₃) ₂		<L	<100	S	11		1	Q ₁ (V)	B	E	G	G			fe	160(Z)		1,50
Calcium bisulfite (lye) → Calcium hydrogen sulfite																			
Calcium carbonate → Lime powder suspension																			
Calcium chlorate	Ca(ClO ₃) ₂		<L	<100	S,Q	62		1	Q ₁ (V)	B	V	G	G	6,0		kr	340(Z)		2,711
Calcium chloride	CaCl ₂		<L	<25	S	11		1	Q ₁ (V)	B	V	G	G						
	CaCl ₂		<L	<100	S,Q	62		1	Q ₁ (V)	B	M ₁	M	M	Xi,3,6		kr	782	>1600	1,68
Calcium hydrogen sulfite (‘Digester lye’)	Ca(HSO ₃) ₂	V	L	<Kp	D	53A		1	Q ₁ (V)	B	M ₁	G	G	3,6		fl			
	Ca(HSO ₃) ₂	V	L	<Kp	S,Q	01	kD	3	Q ₁	Q ₁	M ₁	G	G	3,6		fl			
Calcium hydroxide → Hydrated lime																			
Calcium hypochlorite	Ca(OCl) ₂		<L	<30	S,Q	62		1	Q ₁ (V)	Q ₁ (V)	M ₂	M	M	Xn,C,2,6,0,N					
	Ca(OCl) ₂		-	<Kp	S,Q	62		4	Q ₁	Q ₁	M ₂	M	G	Xn,C,2,6,0,N		kr	100(Z)		2,35
Calcium nitrate	Ca(NO ₃) ₂		<L	<Kp	S,Q	62		1	Q ₁ (S)	B	V	G	G	Xi,6,0					
	Ca(NO ₃) ₂		<L	<100	S	62		5	Q ₁	Q ₁	V	G	G	Xi,6,0		kr	45		1,82
Calcium phosphates (sludges)	Ca(PO ₄) ₂	G	F25	<Kp	S	01	kD	3	Q ₁	Q ₁	M ₁	G	G			kr	1670		3,14
Calcium sulfate (suspension)	CaSO ₄		F25	<Kp	S	01	kD	3	Q ₁	Q ₁	V	G	G			kr			
Calgon (Polyphosphates), Calfort		®	<L	<Kp	S	11		1	Q ₁ (V)	B	E	G	G			kr			
Calgonit R (Sodium phosphate silicates)		®	<L	<Kp	S	11		1	Q ₁ (V)	B	E	G	G			kr			
Calgonit S (Urea nitrate)	CH ₅ N ₃ O ₄	®	<L	<Kp	S	11		1	Q ₁ (V)	B	E	G	G			kr	152(Z)		1,69
Cane sugar (solution)			<L	<Kp	D	53A					V	G	G	3,4		fl			
Caprolactam, ε-	C ₆ H ₁₁ NO C ₆ H ₁₁ NO	TA TA	<L	<Kp <200	S,Q S	62 01	H	6	Q ₁ (S) Q ₁	B Q ₁	M ₁ U ₁	G M ₆	G G ₁	Xn,Xi,6	5 mg	kr	69	268	1,013(80)
Carbamates (Urethanes)		TA,S N	F<5 -	<180 <200	D D	53A 53A	(H)	1	Q ₁ Q ₁ (S)	B A	M ₂ M ₁	G G	G G	T,Xi,3,6		fl			
Carbamides → Urea																			
Carbolic acid → Phenol																			
Carbon dioxide (aqueous solution)	CO ₂		<L	<Kp	S	11		1	Q ₁ (S)	B	P	G	G			fl			

Media				Mechanical Seal										Additional information on the medium					
Code of materials and legend see inside of back cover. Please observe the note on page 1.	Chemical formula	Remark	Concentration %	Temp. °C	Arrangement	Auxil. piping	Addit. measures	Seal type	Materials to EN 12756					Hazard warnings	TLV-value	Normal condition	Melting temperature °C	Boiling point °C	Density g/cm ³
									1	2	3	4	5						
									Seal face	Seal face	Sec. seal	Spring	Others						
1	2	3	4	5	6	7	8	9	10	11	12	13	14	15					
Carbon dioxide (gas)	CO ₂		-	<60	D	53A		1	Q ₁ (S)	B	P	G	G	1	5000	ga		-78(S)	(+)
Carbon dioxide (liquefied, min. 3 bar above PD)	CO ₂		-	<Kp	S,Q	11		X	Q ₁	A	P	G	G	4,6	5000	fl			0,766
Carbon disulfide	CS ₂	TA	-	<Kp	D	62		1	Q ₁	Q ₁	M ₁	G	G	T,Xi,R62,R63,F,3	10	fl	-111	46	1,261
Carbon monoxide	CO		-	<60	D	53A		1	Q ₁ (S)	B	P	G	G	T,1,4,F+	30	ga	-205	-191	(-)
Carbon tetrachloride (Tetrachloromethane)	CCl ₄	TA	-	<60	S,Q	62		1	Q ₁ (V)	B	V	G	G	T,R40,N	10	fl	-23	76	1,5924
Castor oil			-	<100	S	11		1	Q ₁ (S)	B	V	G	G			fl	-10 ... -18		0,96
Caustic ammonia → Ammonia aqu. Solutions																			
Caustic potash solution (Potassium hydroxide in aqueous solution)	KOH		<10	<25	S	11		1	Q ₁	Q ₁	E	G	G	C,Xn		fl			
	KOH		<20	<60	S	11		5	Q ₁	Q ₁	E	G	G	C,Xn		fl			
	KOH		-	<Kp	D	53A		1	Q ₁	Q ₁	M ₂	G	G	C,Xn,2,4		fl			
Caustic soda solution (Sodium hydroxide in aqueous solution)	NaOH		<10	<80>K	S,Q	62		5	Q ₁	Q ₁	E	G	G	C			10%~10	10%~105	10% 1,109
	NaOH		<20	<100>K	S,Q	62		5	Q ₁	Q ₁	E	G	G	C			20%~25	20%~110	20% 1,219
	NaOH		<50	<100>K	S,Q	62	QW	5	Q ₁	Q ₁	E	G	G	C,3			30%~0	30%~120	30% 1,327
	NaOH		<50	<100>K	S,Q	62	QW	1	Q ₁	Q ₁	E	G	G	C,3			40%~15	40%~130	40% 1,430
	NaOH		<50	<100>K	D	53A	SW	1	Q ₁	Q ₁	E	G	G	C,3			50%~12	50%~150	50% 1,524
	NaOH		<50	<180	D	53A	SW	1	Q ₁	Q ₁	M ₂	G	G	C,2			60%~50	60%~160	60% 1,109
Cellosolve (Ethylene glycol monoethyl ether)	C ₄ H ₁₀ O ₂	TA,®	-	<Kp	S,Q	62		1	Q ₁ (S)	B	M ₁	G	G	T,Xn,R60	20	fl	-100	135	0,9311
Cellulose → Pulp																			
Cement sludge			<60	<40	S,Q	62	kD	3	Q ₁	Q ₁	V	G	G	3,6					
Cheese (cream)		N	-	<60	D	53A		1	Q ₁	Q ₁	V	G	G	4		pa			
Chemical pulp → Cellulose																			
Chinese wood oil → Wood oil																			
Chloroacetic acid	C ₂ H ₃ ClO ₂	TA	<L	<100	D	53A	SW	1	Q ₁ (V)	B	M ₂	G	G	T,C,2,N		kr	61	188	1,40
Chlorinated biphenyls		TA,S	-	<60	D	53A		1	Q ₁ (V)	B	M ₁	G	G	T	0,2	fl			
Chlorine	Cl ₂		-	<60	D	54		1	Q ₁	Q ₁	M ₁	G	G	T,Xi,1,2,3,6,N	0,5	ga	-101	-34	(+)
Chlorine bleaching lye → Sodium hypochlorite, Calcium hypochlorite																			
Chlorine dioxide	ClO ₂		-	<60	D	53A	SW	1	Q ₁	Q ₁	M ₁	G	G	T+,C,1,2,6,0,N	0,1	ga	-59	11	(+)
Chlorine lye → Sodium hypochlorite																			
Chlorine water	Cl ₂ +H ₂ O		L	<Kp	D	54		1	Q ₁ (V)	B	M ₁	G	G	C,2,6		fl			
Chloroacetone (1-Chlorine- 2-propanone)	C ₃ H ₅ ClO	TA	-	<60	S,Q	62		1	Q ₁ (V)	B	M ₁	G	G	T,3,N		fl	-44	119	1,123
Chlorobenzene	C ₆ H ₅ Cl	TA	-	<Kp	D	53A		1	Q ₁ (V)	B	M ₁	G	G	Xn,N	50	fl	-46	132	1,106
Chlorofluorocarbons (CFC) → Refrigerants																			
Chloroform	CHCl ₃	TA	-	<Kp	D	62		1	Q ₁ (S)	B	M ₁	G	G	Xn,Xi,R40	10	fl	-63	61	1,48
Chloromethane → Methyl chloride																			
Chloropicrine → Trichloronitromethane																			
Chlorosulfuric acid (Chlorosulfonic acid)	HOSO ₂ Cl		-	<Kp	D	54		1	Q ₁	Q ₁	M ₁	G	G	C,Xi		fl	-80	152(Z)	1,75
Chloroethene → Trichloroethane																			
Chrome alum (Potassium chrome alum)	KCr(SO ₄) ₂ *12H ₂ O		<L	<Kp	S,Q	62		1	Q ₁ (V)	B	M ₁	G	G	6		kr	89		1,83
Chromic acid (Chromic anhydride) → Chromium trioxide																			
Chromium trioxide	CrO ₃		<L	<Kp	D	53A		1	Q ₁	Q ₁	M ₁	G	G	T+,C,R45,R46,R62,2,6,0,N	mg 0,1	kr	197	>230(Z)	2,7
Citric acid	C ₆ H ₈ O ₇		<L	<Kp	S	11		1	Q ₁ (S)	B	V	G	G	Xi		kr	153	200(Z)	1,66
Citrus juices		N	-	<Kp	S	11		1	Q ₁ (S)	B	V	G	G			fl			
Clairce → Sugar juices																			
Clophen → Chlorinated biphenyls																			
Coal sludge				<60	S	32		1	U ₁	U ₁	P	G	G			pa			
Coal tar (remove leakage selectively)		TA,G	-	<180	S,Q	11	(H)	1	Q ₁ (S)	B	M ₁	G	G	T,R45,1,6	*	fl		1,1...1,2	
Cocoa butter (Cacao butter)		N	Sch	<100	S	11		1	Q ₁ (S)	B	V	G	G			pa	33...35		0,975

Mechanical seal selection by media

Media				Mechanical Seal										Additional information on the medium					
Code of materials and legend see inside of back cover. Please observe the note on page 1.	Chemical formula	Remark	Concentration %	Temp. °C	Arrangement	Auxil. piping	Addit. measures	Seal type	Materials to EN 12756					Hazard warnings	TLV-value	Normal condition	Melting temperature °C	Boiling point °C	Density g/cm ³
									1	2	3	4	5						
									Seal face	Seal face	Sec. seal	Spring	Others						
1	2	3	4	5	6	7	8	9	10	11	12	13	14	15					
Coconut fat		N	-	>30<TG	S	11		1	Q ₁ (S)	B	V	G	G			pa	20...23		0,88...0,9
Coconut oil		N	-	<160	S	11		1	Q ₁ (S)	B	V	G	G			fl			
Cod-liver oil		N	-	<Kp	S	11		1	Q ₁ (S)	B	V	G	G			fl			0,92...0,93
Coffee (extract)		N	L	<60	S	11		1	Q ₁	Q ₁	V	G	G			fe			
Coin		®	-	<30	S	11		1	Q ₁ (S)	B	V	G	G			fl			
Coke oven gas			-	<160	D	53A		1	Q ₁ (V)	B	V	G	G	1,U	*	ga			
Cold zinc paint		G	<L	<60	D	53A		1	Q ₁ (S)	B	E	G	G	3,4		fe			
Colza oil (Rapeseed oil)		N	-	<100	S	11		1	Q ₁ (S)	B	V	G	G			fl	-10...-2	350	0,91
Condensed milk		N	-	<Kp	S	11		1	Q ₁ (S)	B	V	G	G			fl			
Cooling brine → Calcium chloride																			
Copper (II) acetate	C ₄ H ₆ CuO ₄		<L	<40	S	11		1	Q ₁ (V)	B	E	G	G	Xn		kr	115	~240(Z)	1,882
Copper chlorides:																			
Copper chloride	CuCl		<L	<Kp	D	53A		1	Q ₁ (V)	B	E	G	G	Xn,N,2,3		kr	430	1490	4,14
Copper (II) chloride	CuCl ₂		<L	<Kp	D	53A		1	Q ₁ (V)	B	E	G	G	Xn,N,2,3		kr	>300(Z)		3,386
Copper (I) cyanide suspension		TA	<10	<Kp	D	53A		1	Q ₁ (V)	B	M ₁	G	G	T+,N	5	kr	473		2,92
Copper (II) nitrate	Cu(NO ₃) ₂ Cu(NO ₃) ₂		<L	<60	S	11		5	Q ₁	Q ₁	E	G	G	Xn,O		kr		>150(S)	
			<L	<Kp	D	53A		1	Q ₁	Q ₁	M ₂	G	G	Xn,O					
Corn mash		N	-	<Kp	S	11		1	Q ₁ (S)	B	V	G	G			fl			
Corn oil		N	-	<100	S	11		1	Q ₁ (S)	B	V	G	G			fl	-18...-10		0,91...0,93
Cottonseed oil		N	-	<120	S	11		1	Q ₁ (S)	B	V	G	G			fl	-2		0,92
Cream		N	-	<60	S	11		1	Q ₁ (S)	B	V	G	G			fl			
Creosot		TA	-	<Kp	S	11		1	Q ₁ (S)	B	M ₁	G	G	T,R45		fl	<-20	200...220	1,08...1,09
Cresols:																			
m-Cresol	C ₇ H ₈ O	TA	Sch	<Kp	D	53A		1	Q ₁ (V)	A	M ₁	G	G	T,C	5	kr	31	191	1,05
o-Cresol	C ₇ H ₈ O	TA		<Kp	D	53A		1	Q ₁ (V)	A	M ₁	G	G	T,C	5	fl	11	203	1,03
p-Cresol	C ₇ H ₈ O	TA	Sch	<Kp	D	53A		1	Q ₁ (V)	A	M ₁	G	G	T,C	5	fe	36	202	1,018
Crude oil, free from solid particles		TA,N	-	<100	S	11		1	Q ₁ (S)	B	V	G	G	T,R45		fl			
Crude oil, refined		TA,N	-	<80	S	11		1	Q ₁ (S)	B	V	G	G	T,R45		fl			
Crude oil, with sand		TA,N	-	<100	S	11		1	Q ₁	Q ₁	V	G	G	T,R45		fl			
Crude oil + salt water		TA,N	-	<25	S	11		1	Q ₁ (V)	B	V	G	G	T,R45		fl			
Crude soap			-	>F<100	S	11		1	Q ₁ (S)	B	V	G	G			fl			
Cryolith (suspension)	Na ₃ (AlF ₆)		<30	<Kp	S	02	kD	3	Q ₁	Q ₁	E	G	G	T,Xn,N		kr	~1000		2,95
Cumene (Isopropylbenzene)	C ₉ H ₁₂	TA	-	<Kp	D	53A		1	Q ₁ (V)	B	M ₁	G	G	Xn,N	50	fl	-96	152 ... 153	0,864
Cupric sulphate (Blue vitriol)	CuSO ₄ *5H ₂ O		<L	<Kp	S	11		5	Q ₁	Q ₁	E	G	G	Xn		kr	560(Z)		3,603
Curd		N	-	<60	S	11		1	Q ₁ (S)	B	V	G	G			pa			
Cutting fluid → Metal working lubricants																			
Cyanide of potassium → Potassium cyanide																			
Cyclohexane	C ₆ H ₁₂	TA	-	<Kp	S	11		1	Q ₁ (S)	B	V	G	G	F,Xn,Xi,N	300	fl	7	80	0,788
Cyclohexanol	C ₆ H ₁₂ O		-	>F<Kp	S,Q	62		1	Q ₁ (S)	B	M ₁	G	G	Xn,Xi,6	50	fe	25	161	0,962
Cyclohexanone	C ₆ H ₁₀ O		-	<Kp	S,Q	62		1	Q ₁ (S)	B	M ₁	G	G	Xn	*	fl	-26	155	0,964
Cyclopentadiene	C ₅ H ₆	TA	-	<Kp	S,Q	62		1	Q ₁ (S)	B	M ₁	G	G	1,6	75	fl	-97	40	0,802
Cymene, p-; (1-Isopropyl-4-methylbenzene)	C ₁₀ H ₁₄		-	<60	S	11		1	Q ₁ (V)	B	V	G	G	Xi		fl	-68	177	0,86

D																			
Decahydronaphthalene → Decalin																			
Decalin (Decahydronaphthalene):																			
cis-Decalin	C ₁₀ H ₁₈	TA	-	<Kp	S,Q	62		1	Q ₁ (S)	B	M ₁	G	G	C,N		fl	-43	196	0,896
trans-Decalin	C ₁₀ H ₁₈	TA	-	<Kp	S,Q	62		1	Q ₁ (S)	B	M ₁	G	G	C,N		fl	-30	187	0,870
Denatured alcohol → Ethanol																			
Desalinated water → Water																			
Desmodur R		®	-	<Kp	D	53A		1	Q ₁ (S)	B	M ₁	G	G	Xn,U		fl			
Desmodur T		TA,®	-	<Kp	D	53A		1	Q ₁ (S)	B	M ₁	G	G	T+,Xi,R40		fl	21	251	1,22
Desmophen		®	-	<Kp	D	53A		1	Q ₁ (S)	B	M ₁	G	G	U		fl			
Detergents		S			S	11		1	Q ₁ (S)	B	V	G	G						
Dextrin (Starch gum)		G	<L	<Kp	D	53A		1	Q ₁ (S)	B	V	G	G			fe			
Dextrose → Glucose																			

Media				Mechanical Seal									Additional information on the medium					
Code of materials and legend see inside of back cover. Please observe the note on page 1.	Chemical formula	Remark	Temp. °C	Arrangement	Auxil. piping	Addit. measures	Seal type	Materials to EN 12756					Hazard warnings	TLV-value	Normal condition	Melting temperature °C	Boiling point °C	Density g/cm ³
								1	2	3	4	5						
								Seal face	Seal face	Sec. seal	Spring	Others						
1	2	3	4	5	6	7	8	9	10	11	12	13	14	15				
Diacetone alcohol (4-Hydroxy-4-methyl-2-pentanone)	C ₆ H ₁₂ O ₂		<Kp	S,Q	62		1	Q ₁ (S)	B	M ₁	G	G	Xi,6	50	fl	-47	168	0,93
Diallyl phthalate → Phthalic acid esters																		
Diammonium hydrogen phosphate → Ammonium phosphate, secondary																		
Dibromoethane (Ethylene bromide)	C ₂ H ₄ Br ₂		<100	D	53A		1	Q ₁ (V)	B	M ₂	G	G	T,Xi,R45,N	*	fl	10	132	2,2
Dibutyl ether	C ₈ H ₁₈ O		<Kp	S,Q	62		1	Q ₁ (V)	B	M ₁	G	G	R,6		fl	-98	142	0,769
Dibutyl phthalate (DBP) → Phthalic acid esters																		
Dichlorobenzenes: 1,2-Dichlorobenzene (ortho-dichlorobenzene)	C ₆ H ₄ Cl ₂	TA	-	<Kp	S,Q	62	1	Q ₁ (S)	B	M ₁	G	G	Xn,Xi,N	50	fl	-17	180	1,306
1,3-Dichlorobenzene (meta-dichlorobenzene)	C ₆ H ₄ Cl ₂	TA	-	<Kp	S,Q	11	1	Q ₁ (S)	B	M ₁	G	G	Xn,N		fl	-25	173	1,288
1,4-Dichlorobenzene (para-dichlorobenzene)	C ₆ H ₄ Cl ₂	TA	-	>F<Kp	S,Q	62	1	Q ₁ (S)	B	M ₁	G	G	Xn,Xi,R40,N	50	fe	53	174	1,46
Dichloroethanes: 1,1-Dichloroethane	C ₂ H ₄ Cl ₂	TA	-	<Kp	S,Q	62	1	Q ₁ (V)	B	M ₁	G	G	Xn,Xi,F	100	fl	-97	57	1,175
1,2-Dichloroethane	C ₂ H ₄ Cl ₂	TA	-	<Kp	S,Q	62	1	Q ₁ (V)	B	M ₁	G	G	T,Xn,Xi,R45,F	*	fl	-36	83	1,26
Dichloroethenes: 1,1-Dichloroethene	C ₂ H ₂ Cl ₂	TA	-	<Kp	D	53A	1	Q ₁ (S)	B	V	G	G	Xn,R40,3,F+	2	fl	-122	32	1,213
1,2-Dichloroethene (cis-)	C ₂ H ₂ Cl ₂	TA	-	<Kp	S	11	1	Q ₁ (S)	B	V	G	G	Xn,F,N	200	fl	-81	60	1,284
1,2-Dichloroethene (trans-)	C ₂ H ₂ Cl ₂	TA	-	<Kp	S	11	1	Q ₁ (S)	B	V	G	G	Xn,F,N	200	fl	-50	47*	1,257
Dichloromethan → Methylene chloride																		
Didecyl phthalat → Phthalic acid esters																		
Diesel fuel		TA,G	-	<80	S	11	1	Q ₁ (S)	B	V	G	G			fl		170..390	0,83..0,88
Diethanolamine (DEA, 2,2'-Iminodiethanol)	C ₄ H ₁₁ NO ₂		-	>F<180	S	11	1	Q ₁ (V)	B	M ₂	G	G	Xn,Xi		kr	28	268	1,093
Diethyl ether (‘Ether’, Ethyl ether)	C ₄ H ₁₀ O	TA	-	<Kp	S,Q	11	1	Q ₁ (S)	B	M ₂	G	G	Xn,F+		fl	-116	34	0,715
Diethyl phthalate (DEP) → Phthalic acid esters																		
Diethylamine	(H ₅ C ₂) ₂ NH	TA	-	<Kp	S,Q	62	1	Q ₁ (V)	B	M ₂	G	G	Xn,C,F	10	fl	-50	55	0,711
Diethylene glycol → Ethylene glycols																		
Diethylenetriamine	C ₄ H ₁₃ N ₃	TA	-	<180	S	11	1	Q ₁ (V)	B	M ₂	G	G	Xn,C		fl	-39	207	0,959
Digester liquor, acidic (Sulfite chemical pulp)		V		<140	S	02	kD	3	Q ₁	Q ₁	V	M	G		fl			
		V		>140	D	53A		1	Q ₁ (V)	B	M ₂	G	G	1,4				
Digester liquor, basic (Sulfate chemical pulp)		V		<120	S	02	kD	3	Q ₁	Q ₁	E	M	G		fl			
		V		>120	D	53A		1	Q ₁ (V)	B	M ₂	G	G	1,4				
Diglycolic acid (2,2'-Oxydiacetic acid)	C ₄ H ₆ O ₅		<L	<60	S	11	1	Q ₁ (V)	B	E	G	G	Xn,Xi		fe	148		
Diisobutyl phthalate (DIBP) → Phthalic acid esters																		
Diisodecyl phthalate (DIDP) → Phthalic acid esters																		
Diisononyl phthalate (DINP) → Phthalic acid esters																		
Diisooctyl phthalate (DIOP) → Phthalic acid esters																		
Diluents (solvents for paints and lacquers)		S	-	<40	S	11	1	Q ₁ (S)	A	M ₁	G	G	U		fl			
Dimethyl formamide (DMF)	C ₃ H ₇ NO	TA	-	<Kp	S,Q	62	1	Q ₁ (S)	B	M ₂	G	G	T,Xn,Xi	10	fl	-61	153	0,9445
Di-(methyl glycol)-phthalate → Phthalic acid esters																		
Dimethyl phthalate (DMP) → Phthalic acid esters																		
Dimethyl sulfate	C ₂ H ₆ O ₄ S	TA	-	<Kp	D	53A	1	Q ₁ (S)	B	M ₁	G	G	T+,C,R45	*	fl	-32	191	1,33
Dimethyl sulfoxide (DMSO)	C ₂ H ₆ OS		-	<60	S	11	1	Q ₁ (S)	B	V	G	G			fl	19	189	1,104
Dimethyl terephthalate (DMT)	C ₁₀ H ₁₀ O ₄ C ₁₀ H ₁₀ O ₄	<L Sch	<60 >F<Kp	S S	11 01		1 (H)	6 6	Q ₁ A	B Q1	M ₁ G	G M ₆			kr	141	282	1,35
Dinonyl phthalate → Phthalic acid esters																		
Diocetyl phthalate (DOP) → Phthalic acid esters																		
Dipentene	C ₁₀ H ₁₆	TA	-	<60	S	11	1	Q ₁ (S)	B	V	G	G	Xi,N		fl	-95	178	0,841

Mechanical seal selection by media

Media				Mechanical Seal									Additional information on the medium						
Code of materials and legend see inside of back cover. Please observe the note on page 1.	Chemical formula	Remark	Concentration %	Temp. °C	Arrangement	Auxil. piping	Addit. measures	Seal type	Materials to EN 12756					Hazard warnings	TLV-value	Normal condition	Melting temperature °C	Boiling point °C	Density g/cm ³
									1	2	3	4	5						
									Seal face	Seal face	Sec. seal	Spring	Others						
1	2	3	4	5	6	7	8	9	10	11	12	13	14	15					
Dipentyl phthalate → Phthalic acid esters																			
Diphenyl, diphenyl oxide → Heat transfer oils																			
Diphyl → Heat transfer oils		®																	
Distilled water → Water																			
Disulfurdecafluoride → Sulfur fluorides																			
Disulfur dichloride → Sulfur chlorides																			
Disulfur difluoride → Sulfur fluorides																			
Divinylbenzene (m-), (Vinylstyrene)	C ₁₀ H ₁₀	TA	-	<Kp	S,Q	62		1	Q ₁ (V)	B	M ₁	G	G	Xi,N		fl	-67	199	0,9289
Dodecyl benzene	C ₁₈ H ₃₀		-	<60	S	11		1	Q ₁ (S)	B	V	G	G			fl	-7	331	0,863
Dowtherm → Heat transfer oils		®																	
Drinking water, industrial water → Water																			
Dye liquor with bleaching additives		G	-	<160	S	11		1	Q ₁	B	M ₁	G	G			fl			
Dye liquor without bleaching additives		G	-	<140	S	11		1	Q ₁ (S)	B	V	G	G			fl			

E																			
Code of materials and legend see inside of back cover. Please observe the note on page 1.	Chemical formula	Remark	Concentration %	Temp. °C	Arrangement	Auxil. piping	Addit. measures	Seal type	1	2	3	4	5	Hazard warnings	TLV-value	Normal condition	Melting temperature °C	Boiling point °C	Density g/cm ³
1	2	3	4	5	6	7	8	9	10	11	12	13	14	15	16	17	18	19	20
Edible oil		N	-	<100	S	11		1	Q ₁ (S)	B	V	G	G			fl			
Egg liqueur		N	-	<Kp	D	53A		1	Q ₁ (S)	B	V	G	G	3,4		fl			
Egg yolk		N	-	<Kp	S,Q	62		1	Q ₁ (S)	B	V	G	G	3,4		fl			1,08
Electrophoretic varnishes		G	Sus		D			X	Q ₁	Q ₁	V	T ₆	F						
Enamel slip			Sus	<40	D	53A		5	Q ₁	Q ₁	P	G	G	4					
Engobes (special clays)			Sus	<40	D	53A		5	Q ₁	Q ₁	P	G	G	4					
Epichlorohydrine (ECH)	C ₃ H ₅ ClO	TA	-	<Kp	D	53A		1	Q ₁ (S)	B	M ₂	G	G	T,C,R45	*	fl	-48	117	1,18
Epoxy resins and lacquers		TA	Sus	<Kp	D	53A		1	Q ₁ (V)	B	M ₁	G	G	Xi,3,4,N		fl			
Essential oils → Volatile oils																			
Essotherm → Heat transfer oils		®																	
Esters (not specified); also refer to → Acetic acid esters		S	-	<Kp,TG	S,Q	53A		1	Q ₁ (S)	B	M ₂	G	G	(F),U		fl			
Ethanal → Acetaldehyde																			
Ethane	C ₂ H ₆	TA	-	<60	D	53A		1	Q ₁ (S)	B	V	G	G	F+,1		ga	-183	-88	(+)
Ethanediamine → Ethylenediamine																			
Ethanediol → Ethylene glycol																			
Ethanol	C ₂ H ₅ OH	TA	-	<Kp	S	11		1	Q ₁ (S)	B	E	G	G	F	1000	fl	-114	78	0,794
Ethanolamines → Amino ethanols																			
Ethene → Ethylene																			
Ethenyl ... → Vinyl ...																			
Ether → Diethyl ether																			
Ether sulfates		S	-	<60	S	11		1	Q ₁ (S)	B	V	G	G	U		fl			
Ethyl acetate → Acetic acid ethyl ester																			
Ethyl acetoacetate	CH ₃ COCH ₂ CO ₂ C ₂ H ₅		-	100	S	11		1	Q ₁ (V)	B	M ₂	G	G	Xi		fl	-45	180	1,025
Ethyl acrylate → Acrylic esters																			
Ethyl alcohol → Ethanol																			
Ethylamine (Aminoethane)	C ₂ H ₇ N	TA	-	<60	D	53A		1	Q ₁ (S)	B	E	G	G	F+,Xi,1	10	ga	-80	17	(+)
Ethylbenzene	C ₈ H ₁₀		-	<Kp	S,Q	62		1	Q ₁ (S)	B	M ₁	G	G	Xn,F	100	fl	-94	136	0,867
Ethylchloride (Chloroethane)	C ₂ H ₅ Cl	TA	-	<60	D	53A		1	Q ₁ (V)	B	M ₁	G	G	Xn,R40,F+,1	1000	ga		-138	12(+)
Ethylene (Ethene)	C ₂ H ₄	TA	-	<-20	D	53A	ThE	6	A	Q ₁	G	M ₆	M	F+,1		ga	-169	-104	(-)
Ethylene bromide → Dibromoethane																			
Ethylene chloride → Dichloroethenes																			
Ethylene chlorohydrin (2-Chloroethanol)	C ₂ H ₅ ClO	TA	-	<Kp	D	53A		1	Q ₁ (S)	B	M ₁	G	G	T+	1	fl	-70	129	1,21
Ethylenediamine	C ₂ H ₈ N ₂	TA	-	<60	S,Q	62		1	Q ₁ (S)	B	E	G	G	Xn,C	10	fl	9	116	0,9

Media				Mechanical Seal									Additional information on the medium						
Code of materials and legend see inside of back cover. Please observe the note on page 1.	Chemical formula	Remark	Concentration %	Temp. °C	Arrangement	Auxil. piping	Addit. measures	Seal type	Materials to EN 12756					Hazard warnings	TLV-value	Normal condition	Melting temperature °C	Boiling point °C	Density g/cm ³
									1	2	3	4	5						
									Seal face	Seal face	Sec. seal	Spring	Others						
1	2	3	4	5	6	7	8	9	10	11	12	13	14	15					
Ethylene dichloride → <i>Dichloroethenes</i>																			
Ethylene glycols:																			
Diethylene glycol	C ₄ H ₁₀ O ₃		-	<100	S	11		1	Q ₁ (S)	B	E	G	G	Xn		fl	-6	245	1,12
Ethylene glycol (1,2-Ethanediol, 'Glycol')	C ₂ H ₆ O ₂		-	<100	S,Q	62		1	Q ₁ (S)	B	E	G	G	Xn	10	fl	-16	198	1,113
Tetraethylene glycol	C ₈ H ₁₈ O ₅		-	<100	S	11		1	Q ₁ (S)	B	E	G	G			fl	-6	328	1,128
Triethylene glycol	C ₆ H ₁₄ O ₄		-	<100	S	11		1	Q ₁ (S)	B	E	G	G			fl	-4	291	1,1274
Ethylene oxide	C ₂ H ₄ O	TA	-	<60	D	53A		1	Q ₁ (S)	B	M ₂	G	G	T,Xi,R45,R46,F+,6	*	ga	-111	10	(-)
Ethyl ether → <i>Diethyl ether</i>																			
Ethyl formiate → <i>Formic acid ethyl esters</i>																			
2-Ethylhexanol (Isooctanol)	C ₈ H ₁₈ O		-	<100	S	11		1	Q ₁ (S)	B	V	G	G	Xi		fl	<-76	182	0,834
F																			
Faeces (feces)		N	-	<60	S	11		1	Q ₁	Q ₁	V	G	G			fl			
Fats and fatty oils		N	-	<200	S	11		1	Q ₁ (S)	B	M ₁	G	G			fl			
Fatty acids		G	-	>F,<Kp	S	11		1	Q ₁ (V)	B	M ₁	G	G			fl			
Fatty alcohol sulfates		G	<L	<Kp,>K	S	11		1	Q ₁ (V)	B	V	G	G			fe			
Fatty alcohols		G	-	<100	S	11		1	Q ₁ (S)	B	V	G	G			fl			
Ferric phosphate solution in mineral acids			L	<100	D	53A	SW	1	Q ₁ (V)	B	M ₁	G	G	2,U		kr			2,87
Ferricyanides		G	<L	<Kp,>K	S	11		1	Q ₁ (V)	B	E	G	G			kr			
Finishing agents, dressing agents		S	-	<Kp	S	11		1	Q ₁ (S)	B	V	G	G	U		fl			
Fir needle oils		G	-	<60	S	11		1	Q ₁ (S)	B	V	G	G			fl			0,87...0,88
Fish glue		N	-	<60	S,Q	11		1	Q ₁ (S)	B	V	G	G	3		fl			
Fish liver oils		N	-	<100	S	11		1	Q ₁ (S)	B	V	G	G			fl			
Fish meal		N	Sus	<60	S	02		1	Q ₁	Q ₁	V	G	G			fe			
Fish offals		N	Sus	<60	S	02		1	Q ₁	Q ₁	V	G	G			fe			
Fish oils		N	-	<100	S	11		1	Q ₁ (S)	B	V	G	G			fl			
Fish slurry		N	Sus	<60	S	02		1	Q ₁	Q ₁	V	G	G			fe			
Fixative		G	<L	<60	S,Q	11		1	Q ₁ (S)	B	M ₁	G	G	3		fe			
Fixing bath, acidic			-	<60	S	11		1	Q ₁ (S)	B	V	G	G			fl			
Flue gas desulphurization plants (FGD): all acid suspensions		V	<25	<80	S	02	kD	3	Q ₁	Q ₁	V	M	M			fl			
Fluoroacetic acid	C ₂ H ₃ FO ₂	TA	<L	<Kp	D	53A		1	Q ₁ (V)	B	M ₁	G	G	T+,2,N		kr	35	165	1,369
Fluoroboric acid	HF ₃		-	<60	D	54		1	Q ₁	Q ₁	M ₁	G	G	C,2		fl	-78	130(Z)	1,4
Fluorosilicic acid	H ₂ (SiF ₆) H ₂ (SiF ₆)		-	<60 <25	D S	54 11		1 5	Q ₁ Q ₁	B Q ₁	M ₁ V	G M	G M	C,2		fl		(Z)	1,3
Formaldehyde (Methanal)	HCHO	TA	-	<100	D	53A		1	Q ₁ (V)	B	M ₂	G	G	T,C,R40,R43,1,3	0,5	ga	-117	-19	(+)
Formalin	HCHO	TA,®	-40	<Kp	S,Q	62		1	Q ₁ (V)	B	M ₂	G	G	T,C,R40,R43,1,3		fl			1,122 (40%)
Formamide	CH ₃ NO	TA	-	<60	S	11		1	Q ₁ (S)	B	E	G	G	T,R61		fl	3	210	1,13
Formic acid	HCOOH	TA	100	TG	D	53A	SW	1	Q ₁ (V)	B	M ₂	G	G	C,2	5	fl	8(100%)	101(100%)	1,22 (100%)
	HCOOH	TA	-	<80	S	11	SS	1	Q ₁ (V)	B	M ₂	M	M	C					
	HCOOH	TA	<30	<60	S	11	SS	1	Q ₁ (V)	B	M ₂	G	G	C					
	HCOOH	TA	>30	<30	S	11	SS	1	Q ₁ (V)	B	M ₂	G	G	C					
	HCOOH	TA	>80	<40	S	11	SS	1	Q ₁ (V)	B	M ₂	G	G	C					
	HCOOH	TA	>90	<50	S	11	SS	1	Q ₁ (V)	B	M ₂	G	G	C					
Formic acid ethyl ester (Ethyl formiate)	C ₆ H ₁₀ O ₂	TA	-	<Kp	S,Q	62		1	Q ₁ (S)	B	M ₂	G	G	Xn,F	100	fl	-80	54	0,917
Formic acid methyl ester (Methyl formiate)	C ₂ H ₄ O ₂	TA	-	<Kp	S,Q	62		1	Q ₁ (S)	B	M ₂	G	G	Xn,F+	100	fl	-100	32	0,97
Formylmorpholine, n-(4-Morpholine-carboxaldehyde, NFM)	C ₅ H ₉ NO ₂		-	<80	S	11		1	Q ₁ (S)	B	M ₁	G	G			fl	23	240	1,15
Freon → <i>Refrigerants</i>		®																	
Fresh sludge (sewage works)			-	<60	S	02	kD	2	Q ₁₂	Q ₁₂	V	G	G			fl			
Frigen → <i>Refrigerants</i>		®																	
Fruit juices		N	-	<60	S	11		1	Q ₁ (S)	B	V	G	G			fl			
Fruit mash → <i>Mashes</i>																			
Fruit pulp → <i>Mashes</i>																			
Fuel oils:																			
Fuel oil (bottoms)		TA	-	<120	S	11		1	Q ₁	Q ₁	V	G	G	Xn,R40,N		fl			
Fuel oil EL		TA	-	<120	S	11		1	Q ₁ (S)	B	V	G	G	Xn,R40,N		fl	Pp<-6	155...390	<0,86(15)
Fuel oil L		TA	-	<120	S	11		1	Q ₁ (S)	B	V	G	G	Xn,R40,N		fl			<1,10(15)
Fuel oil M		TA	-	<120	S	11		1	Q ₁ (S)	B	V	G	G	Xn,R40,N		fl			<1,20(15)
Fuel oil S		TA	-	<120	S	11		1	Q ₁ (S)	B	V	G	G	Xn,R40,N		fl	-10...+40		

Mechanical seal selection by media

Media				Mechanical Seal								Additional information on the medium							
Code of materials and legend see inside of back cover. Please observe the note on page 1.	Chemical formula	Remark	Concentration %	Temp. °C	Arrangement	Auxil. piping	Addit. measures	Seal type	Materials to EN 12756					Hazard warnings	TLV-value	Normal condition	Melting temperature °C	Boiling point °C	Density g/cm ³
									1	2	3	4	5						
									Seal face	Seal face	Sec. seal	Spring	Others						
1	2	3	4	5	6	7	8	9	10	11	12	13	14	15					
Fumaric acid	C ₄ H ₄ O ₄		<L	<100	S	11		1	Q ₁ (V)	B	V	G	G	Xi		kr		290(S)	1,625
Furfural (Furfural, Furaldehyde)	C ₅ H ₄ O ₂	TA	-	<100	D	53A		1	Q ₁ (S)	B	M ₂	G	G	T,Xn,Xi,R40	5	fl	-36	162	1,159
Furfuryl alcohol	C ₅ H ₆ O ₂		-	<100	S,Q	62		1	Q ₁ (S)	B	M ₂	G	G	Xn	10	fl	-31	170	1,13
G																			
Gallic acid	C ₇ H ₆ O ₅		<L	<100	S	11		1	Q ₁ (S)	B	V	G	G	Xi		kr	253(Z)		1,69
Galvanic baths			-	<60	S	11		1	Q ₁ (V)	B	V	G	G			fl			
Gas → Petrol																			
Gas oil		TA	-	<140	S	11		1	Q ₁ (S)	B	V	G	G	T,R45		fl			200...360
Gas scrubber water			-	<220	S,Q	62		1	Q ₁ (S)	A	M ₁	G	G			fl			
Gasoline → Petrol			-	<60	S	11		1	Q ₁ (S)	B	V	G	G			fl			
Gasoline-methanol mixture → Petrol-methanol mixture																			
Gelatin			-	<100	S	11		1	Q ₁ (S)	B	V	G	G			fl			
Gilotherm → Heat transfer oils		®																	
Gingerbread dough			-	<60	D	53A		1	Q ₁ (S)	B	V	G	G	4		pa			
Glacial acetic acid → Acetic acid																			
Glauber's salt → Sodium sulphate																			
Glazing slip			<50	<60	D	53A		5	Q ₁	Q ₁	V	G	G	4		pa			
Glucose D- (Dextrose, Grape sugar)	C ₆ H ₁₂ O ₆		<L	<100	S	11		1	Q ₁ (S)	B	V	G	G			kr	146		1,56
Glue			-	<Kp	D	53A		1	Q ₁ (S)	B	V	G	G	3,4		fl			
Glutamic acid (2-Aminoglutamic acid)	C ₅ H ₉ NO ₄		<L	<100	S	11		1	Q ₁ (V)	B	M ₁	G	G			kr	205(Z)		
Glutaric acid (Pentene diacid)	C ₅ H ₈ O ₄		<L	<Kp	S	11		1	Q ₁ (V)	B	M ₁	G	G	Xi		kr	97	303	1,43
Glycerol (1,2,3-Propan-etriol, Glycerine)	C ₃ H ₈ O ₃		-	<120	S	11		1	Q ₁ (S)	B	V	G	G			fl	19	290(Z)	1,261
Glycol → Ethylene glycol																			
Glycol ethers		G	-	<100	S	11		1	Q ₁ (S)	B	E	G	G			fl			
Glycolic acid (Hydroxyacetic acid)	HOCH ₂ COOH	TA	<L	<60	S	11		1	Q ₁ (V)	B	E	G	G	C		kr	80	100(Z)	1,26
Glycols (diols), general		G	-	<100	S	11		1	Q ₁ (S)	B	E	G	G			fl			
Grape sugar → D-Glucose																			
Gypsum sludge	CaSO ₄ *2H ₂ O		<50	<60	D	53A		5	Q ₁	Q ₁	V	G	G	4		pa			
Gypsum suspensions (from FGD, all of them)	CaSO ₄ *2H ₂ O		<25	<80	S	02	kD	3	Q ₁	Q ₁	V	M	G			fl			
H																			
Hair lotions		G	-	<40	S	11		1	Q ₁ (S)	B	V	G	G			fl			
Hair oils		G	-	<40	S	11		1	Q ₁ (S)	B	V	G	G			fl			
Hair shampoos		G	-	<60	D	53A		1	Q ₁ (V)	B	V	G	G			fl			
Halocarbon		®	-	<200	S	11		1	Q ₁ (S)	B	M ₁	G	G			fl			
Heat transfer oils:		G																	
Vapour pressure at operating temperature <1 bar			-	<100	S	11		1	Q ₁ (S)	B	V	G	G			fl			
			-	<220	S,Q	62		1	Q ₁ (S)	A	M ₁	G	G	3		fl			
Vapour pressure at operating temperature < 2 bar			-	<400	S,Q	62		6	A	Q ₁	G	M ₆	T ₄	3		fl			
Vapour pressure at operating temperature > 2 bar			-	<400	D	53A		6	A	Q ₁	G	M ₆	T ₄	3		fl			
Helium	He		-	<80	D	53A		1	Q ₁ (S)	B	M ₁	G	G	1		ga	-272	-268	(-)
Heptane	C ₇ H ₁₆	TA	-	<Kp	S	11		1	Q ₁ (S)	B	V	G	G	Xn,Xi,3,4,T,N	500	fl	-90	98	0,681
Hexachlorobenzene (HCB, Perchlorobenzene)	C ₆ Cl ₆	TA	Sch	<Kp	D	53A		6	Q ₂₂	Q ₁	G	M ₅	M	T,R45,N		kr	231	323...326	2,044
Hexachlorobutadiene (Perchlorobutadiene)	C ₄ Cl ₆	TA	-	<80	D	53A		1	Q ₁ (V)	B	V	G	G	T,R40		fl	-20	215	1,68
Hexachloroethane (Perchloroethane)	C ₂ Cl ₆	TA	<L	<80	D	53A		1	Q ₁ (S)	B	V	G	G	Xn,R40	1	kr		187(S)	2,09
Hexane, -n	C ₆ H ₁₄	TA	-	<Kp	D	11		1	Q ₁ (S)	B	V	G	G	Xn,Xi,R62,F,N	50	fl	-95	68	0,66
Hexan-2-one	C ₆ H ₁₂ O	TA	-	Kp	S,Q	62		1	Q ₁ (S)	B	M ₁	G	G	T,R62	5	fl	-57	127	0,83
Honey		N	-	<100	D	53A		1	Q ₁ (S)	B	V	G	G	3,4		pa			

Media				Mechanical Seal										Additional information on the medium					
Code of materials and legend see inside of back cover. Please observe the note on page 1.	Chemical formula	Remark	Concentration %	Temp. °C	Arrangement	Auxil. piping	Addit. measures	Seal type	Materials to EN 12756					Hazard warnings	TLV-value	Normal condition	Melting temperature °C	Boiling point °C	Density g/cm ³
									1	2	3	4	5						
									Seal face	Seal face	Sec. seal	Spring	Others						
1	2	3	4	5	6	7	8	9	10	11	12	13	14	15					
Hop mash → <i>Mashes</i>																			
Hot water → <i>Water</i>																			
Hydrated lime (Suspension of calcium hydroxide)	Ca(OH) ₂		<10	<80	S	11	kD	5	Q ₁	Q ₁	V	G	G	Xi		kr			2,23
Hydraulic fluids HFA, HFB, HFC, HFD			-	<70	S	11		1	Q ₁ (S)	B	V	G	G	U		fl			
Hydraulic oils H, HL, HLP			-	<80	S	11		1	Q ₁ (S)	B	V	G	G	U		fl			
Hydrazine	N ₂ H ₄		-	<Kp	D	53A		1	Q ₁ (S)	B	E	G	G	T,C,R45,N	*	fl	2	113	1,011
Hydroiodic acid	HI		-	<Kp	D	53A		1	Q ₁	Q ₁	M ₁	G	G	C,2		fl		127(A)	1,7 (A57%)
Hydrobromic acid solution	HBr		-	<Kp	D	53A	SW	1	Q ₁	Q ₁	M ₁	G	G	C,Xi,2,6		fl		126	1,5
Hydrochloric acid	HCl		0,04	<20	S,Q	62		1	Q ₁ (V)	B	V	G	G	Xi,2	#7	fl		5%~101	10,5% 1,05
	HCl		<2	<65	S,Q	62		1	Q ₁ (V)	B	V	M	M	Xi,2	#7	fl		10%~103	20,4% 1,10
	HCl		<10	<25	S,Q	62		1	Q ₁ (V)	B	V	M	M	Xi,2	#7	fl		20%~110	24,3% 1,12
	HCl		<35	<20	S,Q	62		1	Q ₁ (V)	B	V	M	M	C,2	#7	fl		25%~107	28,2% 1,14
	HCl		-	<80	D	53A		1	Q ₁ (V)	B	V	M	M	C,2	#7	fl		30%~95	32,1% 1,16
	HCl																	35%~80	36,2% 1,18
	HCl																	40%~20	40,4% 1,20
Hydrocyanic acid	HCN	TA	-	<Kp	D	53A		1	Q ₁ (V)	B	E	G	G	T+,F+,N	10	fl	-14	26	0,687
Hydrofluoric acid	HF		<40	<20	S,Q	62		1	Q ₁	B	M ₁	M	M	T+,C	3	fl		112(A)	1,13 A38
	HF		<20	<30	S,Q	62		1	Q ₁	B	M ₁	M	M	T+,C	3	fl		20%103	
	HF		-	<10	S,Q	62		1	Q ₁	B	M ₁	M	M	T+,C	3	fl		60%80	
	HF		-	<Kp	D	54		1	Q ₁	Q ₁	M ₁	G	G	T+,C,2	3	fl		100%20	
Hydrofluosilicic acid → <i>Fluorosilicic acid</i>																			
Hydrogen	H ₂		-	<60	D	53A		1	Q ₁ (S)	B	E	G	G	F+,1		ga	-259	-252	(-)
Hydrogen chloride anhydrous	HCl		-	<60	D	54		1	Q ₁ (V)	B	M ₁	G	G	T,C,1,2,3	5	ga	-114	-85	(+)
Hydrogen fluoride (gas)	HF		-	<60	D	54		1	Q ₁	B	M ₂	G	G	T+,C,1,2	3	ga	-83	19	(+)
Hydrogen iodide anhydrous	HI		-	>-20	D	53A		1	Q ₁	Q ₁	M ₁	G	G	C,1		ga	-51	-35	(+)
Hydrogen peroxide	H ₂ O ₂		<90	<Kp	D	53A		1	Q ₁	Q ₁	M ₁	G	G	Xn,C,0,1	1	fl	0	150	1,4467
	H ₂ O ₂		<60	<60	S	11		1	Q ₁	Q ₁	V	G	G						
Hydrogen phosphide (Phosphine)	PH ₃		-	<60	D	53A		1	Q ₁ (V)	B	M ₁	G	G	T+,1,F+,N	0,1	ga	-133	-87	(+)
Hydrogen sulfide	H ₂ S		-	<100	D	62		1	Q ₁ (V)	B	M ₂	G	G	T+,1,F+,N	10	ga	-85	-60	(+)
Hydroxymethyl propionitril → <i>Acetone cyanohydrin</i>																			
Hypochlorous acid	HOCl		-	<40	D	53A		1	Q ₁ (V)	B	V	G	G			fl			
I																			
Ice cream		N	-		S	01		1	Q ₁ (S)	B	V	G	G			pa			
Insecticides (Aqueous solution)		S	<L	<Kp	S,Q	62	QW	1	Q ₁ (S)	B	V	G	G	6,U					
Insulating lacquers		S	Sch	<200	D	53A		1	Q ₁ (S)	A	M ₁	G	G	3,4		fe			
Iodine	I ₂		Sch	<Kp	D	53A		1	Q ₁	Q ₁	M ₁	G	G	Xn,4,6,N	0,1	fe	114	184	4,93
Iodoform (Triiodomethane)	CHI ₃		Sch	<200	D	53A		1	Q ₁	Q ₁	M ₁	G	G	Xn,4,6		fe	119	~218	4,008
Iron chlorides (FeCl ₂ or FeCl ₃)			<15	<25	S	11		1	Q ₁	Q ₁	E	M	M	Xn		kr			
			<L	<Kp	D	11		1	Q ₁ (V)	B	E	G	G	Xn		kr			
Iron sulfates:																			
Iron (II) sulfate (Ferrous sulfate, Iron vitriol)	FeSO ₄		<L	<80	S	11		5	Q ₁	Q ₁	V	G	G	Xn		kr	>400(Z)		
Iron (III) sulfate (Ferric sulfate)	Fe ₂ (SO ₄) ₃		<L	<80	S	11		5	Q ₁	Q ₁	V	G	G	Xn		kr	480(Z)		3,1
Iso ... also see → ...																			
Isoborneol (2-Exo-borneol)	C ₁₀ H ₁₈ O		<L	<Kp	S	11		1	Q ₁ (S)	B	M ₁	G	G	Xi		fe	212(Z)		
Isobutyl acetate → <i>Acetic acid esters</i>																			
Isocyanates		S	Sch	<200	D	53A		1	Q ₁ (V)	B	M ₁	G	G	U					
Isooctane (2,2,4-Trimethylpentane)	C ₈ H ₁₈	TA	-	<40	S	11		1	Q ₁ (S)	B	V	G	G	Xn,Xi,F,N		fl	-110	117	0,692
Isooctanol (2-Ethyl-1-hexanol) → <i>2-Ethyl hexanol</i>																			
Isopentane → <i>Pentanes</i>																			
Isophorone (3,5,5-Trimethylcyclohex-2-enone)	C ₉ H ₁₄ O	TA	-	<40	S,Q	62		1	Q ₁ (S)	B	E	G	G	Xn,Xi,R40	5	fl	-8	215	0,92
Isopropanol → <i>2-Propanol</i>																			
Isopropyl ... → <i>Propyl ...</i>																			

Mechanical seal selection by media

Media				Mechanical Seal									Additional information on the medium							
Code of materials and legend see inside of back cover. Please observe the note on page 1.	Chemical formula	Remark	Concentration %	Temp. °C	Arrangement	Auxil. piping	Addit. measures	Seal type	Materials to EN 12756					Hazard warnings	TLV-value	Normal condition	Melting temperature °C	Boiling point °C	Density g/cm ³	
									1	2	3	4	5							
									Seal face	Seal face	Sec. seal	Spring	Others							
1	2	3	4	5	6	7	8													
Isopropyl alcohol → 2-Propanol																				
Isopropyl methylbenzene → Cymene																				
Isopropylbenzene → Cumene																				

J																				
Jams, marmalades			-	<100	S	11		1	Q ₁ (V)	B	V	G	G			pa				
Jet fuel IP4, IP5		G	-	<40	S	11		1	Q ₁ (S)	B	V	G	G	F		fl		100...280	0,75...0,84	

K																				
Kaurit → Glues																				
Kerosene			-	<100	S	11		1	Q ₁ (S)	B	V	G	G	Xn		fl		175...325	~0,8	
Ketchup		N	-	<80	S,Q	62		1	Q ₁ (V)	B	E	G	G	3		fl				
Krypton	Kr		-	<160	D	53A		1	Q ₁ (S)	B	M ₁	G	G	1		ga		-157	-154	(+)

L																				
Lacquer solvents		S	-	<Kp	S	11		1	Q ₁ (S)	B	M ₁	G	G	U		fl				
Lacquers		S	-	<Kp	D	53A		1	Q ₁ (V)	B	M ₁	G	G	3,4		fl				
Lactic acid	C ₃ H ₆ O ₃		<L	<80	S	11		1	Q ₁ (S)	B	V	G	G	Xi		kr	53		1,206	
Lactose (milk sugar)	C ₁₂ H ₂₂ O ₁₁ C ₁₂ H ₂₂ O ₁₁		<L	<Kp	S	11		1	Q ₁ (V)	B	V	G	G			kr	223		1,525	
Lard		N	Sch	<100	S	11		1	Q ₁ (S)	B	V	G	G			pa	36...42			
Latex (specification necessary)		N	-	<100	S,Q	53A		X	U ₂	Q ₁ (V)	M	G	G	3,4		fl				
Lavender oil		TA,N	-	<Kp	S	11		1	Q ₁ (S)	B	V	G	G	Xi,T		fl		204	0,88...0,90	
Lead (II) acetate (lead sugar)	(CH ₃ COO) ₂ Pb	TA	<L	<100	S	11		1	Q ₁ (S)	B	E	G	G	T,Xn,R62,N		kr	75	~200(Z)	2,5	
Lead sugar → Lead (II) acetate																				
Lecithine		N	-	<100	S	11		1	Q ₁ (S)	B	M ₁	G	G			pa	~200(Z)			
Lemonade syrup			-	<60	S	11		1	Q ₁ (V)	B	V	G	G			fl				
Lemonades			-	<60	S	11		1	Q ₁ (S)	B	V	G	G			fl				
Lignosulfonic acid			<L	<100	D	11		1	Q ₁ (V)	B	M ₁	G	G	4		fe				
Lignite tar		N, TA	-	<140	S	11	(H)	1	Q ₁ (S)	B	V	G	G	T,R45		pa	250 ... 350	0,85 ... 1,0		
Lime water (Ca(OH) ₂ +H ₂ O)	Ca(OH) ₂ Ca(OH) ₂		<10 <50	<80 <80	S,Q S	62 02	QW kD	2 3	Q ₁₂ Q ₁	Q ₁₂ Q ₁	V V	G G	G G	Xi,6 Xi,6						
Lime powder suspension (Calcium carbonate)	CaCO ₃ CaCO ₃ CaCO ₃		<10 <10 <50	<80 <80 <80	S S,Q S	11 62 02	kD QW kD	5 2 3	Q ₄ Q ₁₂ Q ₁	Q ₄ Q ₁₂ Q ₁	V V V	G G G	G G G	6		kr	825(Z)		2,95	
Linseed oil		N	-	<60	S	11		1	Q ₁ (S)	B	V	G	G			fl			0,92...0,94	
Linters		N	Sus	<Kp	D	53A		1	Q ₁ (V)	B	V	G	G			fe				
Liquefied gases acc. to DIN 51622		G	-	<Kp	S	11		1	Q ₁₂	A	V	G	G	F		ga				
Liqueurs, liqueur wines			-	<60	S	11		1	Q ₁ (S)	B	V	G	G			fl				
Liquid ... → ... ,liquid																				
Liquor → Ethanol																				
Liquorice		N	-	<Kp	D	53A		1	Q ₁ (S)	B	V	G	G	4		pa				
Lithium bromide	LiBr		<L	<40	S	11		1	Q ₁	B	V	G	G	Xn		kr	547	1265	3,465	
Lithium chloride	LiCl LiCl		<L <L	<20 <Kp	S D	11 53A		1 1	Q ₁ (V) Q ₁ (V)	B B	V V	G M	G M	Xn Xn,2		kr	613	1360	2,068	
Liver sausage mass			-	<60	S	11		1	Q ₁ (S)	B	V	G	G			pa				
Lubrication oils		S	-	>F<140	S	11		1	Q ₁ (S)	B	V	G	G	U		fl				
Lysoform = 7,7-% → Formaldehyde																				
Lysol		®	-	<60	S	11		1	Q ₁ (V)	B	V	G	G			fl				

M																				
m- ..., meta- ... → ...																				
Magnesium bisulfite → Magnesium hydrogen sulfite																				
Magnesium chloride	MgCl ₂ MgCl ₂		<30 <L	<20 <80	S S	11 11		1 1	Q ₁ (V) Q ₁ (V)	B B	V V	G M	G M			kr	708	1412	2,31...2,33	
Magnesium hydrogen sulfite			<L	<Kp	D	53A		1	Q ₁ (V)	B	M ₁	G	G			kr				

Media				Mechanical Seal								Additional information on the medium							
Code of materials and legend see inside of back cover. Please observe the note on page 1.	Chemical formula	Remark	Concentration %	Temp. °C	Arrangement	Auxil. piping	Addit. measures	Seal type	Materials to EN 12756					Hazard warnings	TLV-value	Normal condition	Melting temperature °C	Boiling point °C	Density g/cm ³
									1	2	3	4	5						
									Seal face	Seal face	Sec. seal	Spring	Others						
1	2	3	4	5	6	7	8	9	10	11	12	13	14	15					
Magnesium hydroxide	Mg(OH) ₂ Mg(OH) ₂ Mg(OH) ₂		<10 <20 <40	<25 <40 <80	S S D	11 11 53A		1	U ₁	U ₁	E	G	G			kr			2,36
									Q ₁	Q ₁	E	G	G						
									Q ₁	Q ₁	E	G	G						
Magnesium nitrate	Mg(NO ₃) ₂ ·6H ₂ O		<L	<25	S	11		1	Q ₁ (V)	B	M ₁	G	G	0		fe	89		1,64
Magnesium sulfate	MgSO ₄		<L	<Kp	S	11		1	Q ₁ (V)	B	V	G	G			kr	1124		2,66
Maleic acid	C ₄ H ₄ O ₄		<L	<100	S	11		1	Q ₁ (V)	B	V	G	G	Xn,Xi		kr	140	160(Z)	1,590
Malic acid (Hydroxysuccinic acid)	C ₄ H ₆ O ₅		<L	<60>K	S	11		1	Q ₁ (S)	B	E	G	G	Xi		kr	132		1,6
Malonic acid	C ₃ H ₄ O ₄		<L	<60	S	53A		1	Q ₁ (V)	B	M ₂	G	G	Xn		kr	135		1,62
Manganese(II)-chloride	MnCl ₂ ·4H ₂ O		<L	<Kp	D	53A		1	Q ₁ (V)	B	M ₁	G	G	Xn,2		kr	58		2,01
Manganese(II)-nitrate	Mn(NO ₃) ₂ ·6H ₂ O		<L	<Kp	S	11		1	Q ₁ (V)	B	E	G	G	0		kr	37	129	2,13
Manganese sulfates:																			
Manganese(II)-sulfate	MnSO ₄		<L	<60	S	11		1	Q ₁ (V)	B	M ₁	G	G	Xn,N		fe	700	850(Z)	3,25
Manganese(III)-sulfate	Mn ₂ (SO ₄) ₃		<L	<60	S	11		1	Q ₁ (V)	B	M ₁	G	G	U		kr	160(Z)		
Manganese(IV)-sulfate	Mn(SO ₄) ₂		<L	<60	S	11		1	Q ₁ (V)	B	M ₁	G	G	U		kr			
Manure, liquid		N	-	<60	S	11		1	Q ₁	Q ₁	P	G	G			fi			
Marlotherm → Heat transfer oils		®																	
Mashes:																			
Fruit mash			Sus	<Kp	S	11		1	Q ₁ (S)	B	V	G	G			fi			
Fruit pulp			Sus	<Kp	S	11		1	Q ₁ (S)	B	V	G	G			fi			
Hop mash			Sus	<Kp	S	11		1	Q ₁ (S)	B	V	G	G			fi			
Mustard mash			Sus	<Kp	S	11		1	Q ₁ (V)	B	V	G	G			fi			
Potato mash			Sus	<Kp	S	11		1	Q ₁ (S)	B	V	G	G			fi			
Salt mash			<L	<Kp	S,Q	62		4	Q ₁	Q ₁	V	M	M	2,4,6		fi			
Masut			-	<100	S	11		1	Q ₁ (S)	B	V	G	G	U		fi			
			-	<200	S	11		1	Q ₁ (S)	A	M ₁	G	G	U		fi			
Mayonnaise			-	<40	S	11		1	Q ₁ (V)	B	V	G	G			pa			
MDEA → N-Methyl-2,2'-iminodiethanol																			
MEA → N-Methyl ethanolamine																			
Meat juice, meat broth		N	-	<60	S	11		1	Q ₁ (S)	B	V	G	G			fi			
MEK → Butanone																			
Melamine resins		S	-	<100	D	53A		1	Q ₁ (V)	B	M ₁	G	G	U,3,4		fi			
Mercaptanes → Thiols																			
Mercuric chlorides:																			
Mercuric chloride	HgCl ₂		<L	<Kp	D	53A		1	Q ₁ (V)	B	V	G	G	T+,C,2,N		kr	280	302	5,44
Mercurous chloride (Calomel)	Hg ₂ Cl ₂		<L	<100	D	53A		1	Q ₁ (V)	B	V	G	G	Xn,Xi,2,N		kr		385(S)	7,15
Mercury	Hg		-	<60	D	53A		1	Q ₁ (S)	B	V	G	G	T,4,6,N	0,01	fi	-38	356	13,5939
Mercury (I) nitrate	Hg ₂ (NO ₃) ₂		<L	<Kp	S,Q	62		1	Q ₁ (V)	B	V	G	G	T+,N		kr		70(Z)	
Mesityl oxide	C ₈ H ₁₀ O		-	<Kp	D	53A		1	Q ₁ (S)	B	M ₁	G	G	Xn,3	25	fi	-59	130	0,854
Metal working lubricants: for finishing machines for other machine tools			-	<80	D	53A		5	Q ₁	Q ₁	V	G	G	U		fi			
			-	<80	D	11		5	Q ₁	Q ₁	V	G	G	U		fi			
Methacrylic acid methylester (Methyl methacrylate)	C ₅ H ₈ O ₂	TA	-	<Kp	D	53A		1	Q ₁ (V)	B	M ₂	G	G	Xi,F	50	fi	-48	100	0,944
Methanal → Formaldehyde																			
Methane	CH ₄		-	<60	D	53A		1	U ₂	A	V	G	G	F+,1		ga	-182	-161	(-)
Methanol (Methyl alcohol)	CH ₃ OH	TA	-	<60	S,Q	62		1	Q ₁ (S)	B	E	G	G	F,T	200	fi	-98	64	0,787
Methyl acetate → Acetic acid methyl ester																			
Methyl acrylate (Acrylic acid methyl ester)	C ₄ H ₆ O ₂	TA	-	<Kp	D	53A		1	Q ₁ (V)	B	M ₂	G	G	Xn,Xi,F	5	fi	-75	80	0,954
Methyl alcohol → Methanol																			
Methyl bromide (Bromomethane)	CH ₃ Br	TA	-	<60	D	53A		1	Q ₁ (V)	B	M ₁	G	G	T,Xn,Xi,1,2,N	5	ga	-94	4	(+)
3-Methylbutan-2-one (Methyl isopropyl ketone)	C ₅ H ₁₀ O	TA	-	<Kp	S,Q	62		1	Q ₁ (V)	B	M ₂	G	G	F		fi	-92	95	0,80
Methyl butyrate → Butyric acid esters																			
Methyl cellosolve → Ethylene glycol																			
Methyl chloride	CH ₃ Cl	TA	-	<80	D	53A		1	Q ₁ (V)	B	M ₁	G	G	Xn,R40,F+	50	ga	-97	-25	(+)
Methyl chloroform → 1,1,1-Trichloroethane																			
Methyl cyclohexanone, mixture of isomers	C ₇ H ₁₂ O		-	<Kp	S,Q	62		1	Q ₁ (S)	B	M ₂	G	G	Xn	50	fi	-73...-14	165...170	0,92...0,93

Mechanical seal selection by media

Media				Mechanical Seal										Additional information on the medium					
Code of materials and legend see inside of back cover. Please observe the note on page 1.	Chemical formula	Remark	Concentration %	Temp. °C	Arrangement	Auxil. piping	Addit. measures	Seal type	Materials to EN 12756					Hazard warnings	TLV-value	Normal condition	Melting temperature °C	Boiling point °C	Density g/cm ³
									1	2	3	4	5						
									Seal face	Seal face	Sec. seal	Spring	Others						
1	2	3	4	5	6	7	8	9	10	11	12	13	14	15					
Methylene chloride	CH ₂ Cl ₂	TA	-	<80	D	53A		1	Q ₁ (V)	B	M ₁	G	G	Xn,R40,1,3,4	100	fl	-96	40	1,325
Methyl ethanolamine, N-	C ₃ H ₉ NO		-	Kp	S,Q	62		1	Q ₁	B	M ₂	G	G	Xn,C		fl	-3	158	0,937
Methyl ethyl ketone → <i>Butanone</i>																			
Methyl formiate → <i>Formic acid methyl ester</i>																			
Methyl-2,2'-imino-diethanol, N (N-methyldiethanolamine)	C ₆ H ₁₃ NO ₂		-	<180	S,Q	62		1	Q ₁	B	M ₂	G	G	Xi		fl	-21	243	1,04
Methyl isobutyl ketone (MIBK) → <i>4-Methylpentan-2-one</i>																			
Methyl isopropyl ketone → <i>3-Methylbutan-2-one</i>																			
Methyl methacrylate (MMA) → <i>Methacrylic acid methyl ester</i>																			
Methylnaphthalenes: 1-Methylnaphthalene	C ₁₁ H ₁₀	TA	-	<160	S	11		1	Q ₁ (S)	B	M ₁	G	G	Xn,N		fl	-30	245	1,020
2-Methylnaphthalene	C ₁₁ H ₁₀	TA	Sch	<160	S	11	(H)	1	Q ₁ (S)	B	M ₁	G	G	Xn,N		kr	35	241	1,005
4-Methylpentan-2-one	C ₆ H ₁₂ O	TA	-	<100	S	11		1	Q ₁	B	M ₂	G	G	Xn,Xi,F	100	fl	-80	117	0,80
Methyl pyrrolidone, N- (1-Methyl-2-pyrrolidinone, NMP)	C ₅ H ₉ NO		-	<100	S	11		1	Q ₁	B	M ₂	G	G	Xi	20	fl	-24	206	1,028
Milk		N	-	<40	S	11		1	Q ₁ (S)	B	V	G	G			fl			
Milk sugar → <i>Lactose</i>																			
Mineral oils		S	-	<80	S	11		1	Q ₁ (S)	B	V	G	G			fl			
Miscella			-	<60	S	11		1	Q ₁ (S)	B	V	G	G			fl			
Mobiltherm → <i>Heat transfer oils</i>		®																	
Molasse			-	<100	S,Q	62		1	Q ₁₂	Q ₁₂	V	G	G	3,4		fl			
Mono ... → ...																			
Monoethanolamine → <i>2-Aminoethanol</i>																			
Mud			Sus	<40	S,Q	62	kD	3	Q ₂	Q ₂	V	M	G			fl			
Mustard			-	<60	S,Q	62		1	Q ₁	Q ₁	V	G	G			pa			
Mustard mash → <i>Mashes</i>																			

N																			
Naphtha		TA,G	-	<Kp	S	11		1	Q ₁ (S)	B	M ₁	G	G	T,R45,F,N		fl		30... >200	
Naphthalene	C ₁₀ H ₈	TA	Sch	<Kp	S,Q	62	(H)	1	Q ₁ (S)	B	M ₁	G	G	Xn,R40,N	10	kr	81	218	1,14
Naphthenic acids		G	-	<60	S	11		1	Q ₁ (V)	B	V	G	G	Xi		fl	~30	132...243	0,94...1,03
Naphthol dyes		G	<L	<140	S	11		1	Q ₁ (V)	B	V	G	G	U		kr			
Naphthylamines: 1-Naphthylamine	C ₁₀ H ₉ N	TA	Sch	<150	S	11	(H)	1	Q ₁ (V)	B	M ₂	G	G	Xn,N		kr	50	301	1,13
2-Naphthylamine	C ₁₀ H ₉ N	TA	<L	<Kp	D	53A		1	Q ₁ (V)	B	M ₂	G	G	T,Xn,R45,N	*	kr	110	306	1,216
Natural gas			-	<60	D	53A		1	Q ₁ (S)	A	V	G	G	1,F		ga			
Neon	Ne		-	<80	D	53A		1	Q ₁ (S)	B	N	G	G	1		ga	-248	-247	(-)
Neopentane (2,2-Dimethylpropane) → <i>Pentanes</i>																			
NFM → <i>n-Formylmorpholine</i>																			
Nickel (II) chloride	NiCl		<L	<Kp	D	53A		1	Q ₁ (V)	B	M ₁	G	G	T,R45,2,N		kr	1030		3,55
Nickel (II) sulfate	NiSO ₄		<L	<Kp	D	53A		1	Q ₁ (V)	B	M ₁	G	G	Xn,R40,N		kr	>840(Z)		3,68
Nitrating acid		G	-	<80	D	53A		1	Q ₁ (V)	B	M ₁	G	G	C,2,0		fl			
Nitric acid	HNO ₃		<40	<20	S,Q	62	QW	1	Q ₁ (V)	B	M ₁	G	G	C	2	fl	10%-6	10% 102	10% 1,054
	HNO ₃		<30	<90	S,Q	62	QW	1	Q ₁	Q ₁	M ₁	G	G	C	2	fl	20%-18	20% 104	20% 1,115
	HNO ₃		<50	<80	S,Q	62	QW	1	Q ₁	Q ₁	M ₁	G	G	C	2	fl	30%-36	30% 107	30% 1,180
	HNO ₃		<60	<70	S,Q	62	QW	1	Q ₁	Q ₁	M ₁	G	G	C	2	fl	40%-28	40% 111	40% 1,246
	HNO ₃		<70	<60	S,Q	62	QW	1	Q ₁	Q ₁	M ₁	M	M	C	2	fl	50%-19	50% 115	50% 1,310
	HNO ₃		<80	<50	S,Q	62	QW	1	Q ₁	Q ₁	M ₁	M	M	C	2	fl	60%-21	60% 118	60% 1,367
	HNO ₃		<90	<30	S,Q	62	QW	1	Q ₁	Q ₁	M ₁	M	M	C	2	fl	70%-41	70% 120	70% 1,413
Nitric acid, fuming	HNO ₃		>90	<120	D	53A	SW	1	Q ₁	Q ₁	M ₁	M	M	C,0,2	2	fl	80%-38	80% 113	80% 1,452
	HNO ₃																90%-65	90% 96	90% 1,483
	HNO ₃																100%-41	100% 83	100% 1,513
Nitrobenzene	C ₆ H ₅ NO ₂	TA	-	<80	D	53A		1	Q ₁ (V)	B	M ₁	G	G	T,R40,R62,N	1	fl	5...6	211	1,19867
Nitrochloroform → <i>Trichloronitromethane</i>																			
Nitrogen	N ₂		-	<100	D	53A		1	Q ₁ (S)	B	E	G	G	1		ga	-210	-196	(-)
Nitroglycerine	CH ₅ (NO ₃) ₃	TA	-	<60	D	53A		1	Q ₁ (S)	B	E	G	G	T+,E,N	0,05	fl	14		1,59

Media				Mechanical Seal									Additional information on the medium						
Code of materials and legend see inside of back cover. Please observe the note on page 1.	Chemical formula	Remark	Concentration %	Temp. °C	Arrangement	Auxil. piping	Addit. measures	Seal type	Materials to EN 12756					Hazard warnings	TLV-value	Normal condition	Melting temperature °C	Boiling point °C	Density g/cm ³
									1	2	3	4	5						
									Seal face	Seal face	Sec. seal	Spring	Others						
1	2	3	4	5	6	7	8	9	10	11	12	13	14	15					
Nitromethane	CH ₃ NO ₂	TA	-	<Kp	D	53A		1	Q ₁ (V)	B	M ₁	G	G	Xn		fl	-29	101	1,13
Nitrosylsulfuric acid	NOHSO ₄		<L	<80	D	53A		1	Q ₁ (V)	B	M ₁	G	G	C,O		kr	73(Z)		
NMP → <i>N-Methyl pyrrolidone</i>																			
4-Nonylphenol	C ₁₅ H ₂₄ O	TA	Sch	<220	S,Q	01	(H)	6	A	Q ₁ (S)	M ₇	T ₆	G ₁	C,N		pa	2	295...304	0,95

O																			
o-..., ortho... → ...																			
Octane	C ₈ H ₁₈	TA	-	<Kp	S	11		1	Q ₁ (S)	B	V	G	G	Xn,Xi,F,N	500	fl	-57	126	0,703
4-Octylphenol	C ₁₄ H ₂₂ O	TA	Sch	<220	S,Q	01	(H)	6	A	Q ₁	U ₁	M ₆	G ₁	C,N		fe	~80	277	0,95
Oil lacquer paints		G	-	<40	D	53A		1	Q ₁ (S)	B	M ₁	G	G	U,3,4		fl			
Oils (not specified)		S	-	<100	S	11		1	Q ₁ (S)	B	V	G	G	U		fl			
Oleic acid			-	<Z	S,Q	62		1	Q ₁ (S)	B	M ₁	G	G	3		fl	16	360	0,8935
Oleum → <i>Sulfuric acid, fuming</i>																			
Olive oil		N	-	<100	S	11		1	Q ₁ (S)	B	V	G	G			fl	~6		0,91...0,92
Oxalic acid (Ethanedioic acid)	C ₂ H ₂ O ₄ C ₂ H ₂ O ₄	TA TA	<L <L	<Kp <25	S,Q S,Q	62 62		1 1	Q ₁ (V) Q ₁ (V)	B B	V E	M G	M M	Xn Xn		kr		>100(S)	1,901(25)
2-Oxazolidinone (2-Oxazolidone)	C ₃ H ₅ NO ₂	TA	Sch	<200	D	53A	(H)	1	Q ₁	Q ₁	M ₁	G	G	Xn,3,4,R40		kr	85...89	220(64)	
Ozone	O ₃		-	<40	D	53A		1	Q ₁	Q ₁	K ₁₃	G	G	T+,C,1,0	0,1	ga	-192	-112	(+)

P																			
p-..., para-... → ...																			
Palatal		®,G	-	<60	S,Q	62		1	Q ₁ (S)	B	V	G	G	U,3		fl			
Palatino® → <i>Phthalic acid esters:</i> Palatino A (DEP) Palatino AH (DOP) Palatino C (DBP) Palatino M (DMP) Palatino N (DINP) Palatino O (DIBP) Palatino Z (DIDP)																			
Palmitic acid	C ₁₆ H ₃₂ O ₂		Sch	<200	S	01	(H)	6	B	Q ₁	M ₇	M ₆	G ₁			kr	63	351	0,8577(62)
Paradichlorobenzene → <i>Dichlorobenzene</i>																			
Paraffin waxes		TA,G	Sch	<160	S	11	(H)	1	Q ₁ (S)	B	V	G	G	T,R45		pa			
Paraffins, paraffin oil		S	-	<160	S	11		1	Q ₁ (S)	B	V	G	G			fl			
Paraterphenyl → <i>Terphenyls</i>																			
Paste (for gluing)		G		<Kp	D	53A		1	Q ₁ (S)	B	V	G	G	3,4		pa			
Peanut oil		N	-	<150	S	11		1	Q ₁ (S)	B	V	G	G			fl			
Pentanes: Isopentane (2-Methylbutane) Neopentane (2,2-Dimethylpropane) n-Pentane	C ₅ H ₁₂ C ₅ H ₁₂ C ₅ H ₁₂	TA TA TA	- - -	<Kp <Kp <Kp	S S S	11 11 11		1 1 1	Q ₁ (S) Q ₁ (S) Q ₁ (S)	B B B	V V V	G G G	G G G	Xn,F+,N F+,N Xn,F+,N	1000 1000 1000	fl ga fl	-160 -16 -130	27 9 36	0,62 0,6262
3-Pentanol	C ₅ H ₁₂ O	G	-	<60	S,Q	62		1	Q ₁ (S)	B	E	G	G	Xn,Xi	\$100	fl	<-50	116	0,82
Pentyl acetate → <i>Acetic acid pentyl esters</i>																			
Perchlorobenzene → <i>Hexachlorobenzene</i>																			
Perchloroethane → <i>Hexachloroethane</i>																			
Perchloroethylene → <i>Tetrachloroethylene</i>																			
Perhydrol → <i>Hydrogen peroxide, 30% solution</i>																			
Petrol (Gasoline) unleaded, regular and supergrade		TA,G	-	<40	S	11		1	Q ₁ (S)	B	V	G	G	T,Xn,R45,F+,N		fl		40...200	0,72...0,76
Petrol ether → <i>Petrol, Gasoline</i>																			
Petrolatum		G	Sch	<160	S	11		1	Q ₁ (S)	B	V	G	G			pa	38...60	>300	0,82...0,88
Petroleum		G	-	<160	S	11		1	Q ₁ (S)	B	V	G	G			fl	-20	150...280	
Petrol-methanol mixture		TA,G	-	<40	S	11		1	Q ₁ (S)	B	M ₁	G	G	T,Xn,R45,F+,N		fl			

Media				Mechanical Seal					Additional information on the medium										
Code of materials and legend see inside of back cover. Please observe the note on page 1.	Chemical formula	Remark	Concentration %	Temp. °C	Arrangement	Auxil. piping	Addit. measures	Seal type	Materials to EN 12756					Hazard warnings	TLV-value	Normal condition	Melting temperature °C	Boiling point °C	Density g/cm ³
									1	2	3	4	5						
									Seal face	Seal face	Sec. seal	Spring	Others						
1	2	3	4	5	6	7	8	9	10	11	12	13	14	15					
Potassium dichromate	K ₂ Cr ₂ O ₇ K ₂ Cr ₂ O ₇		<L <L	<40 <Kp	S,Q D	62 53A		1 1	Q ₁ (V) Q ₁ (V)	B B	E M ₁	G G	G G	T+,Xn,C,R45,R46,R60,6,N T+,C,R45,R46,R60,2,6,N		kr		500(Z)	2,7
Potassium hydrogen carbonate (Potassium bicarbonate)	KHCO ₃		<L	<60	S,Q	62		1	Q ₁ (V)	B	E	G	G	6		kr	200(Z)		2,17
Potassium hydroxide → Caustic potash solution																			
Potassium hypochlorite	KOCl		<L	<60	S	11		1	Q ₁ (V)	Q ₁ (V)	M ₂	M	M	C,D		fl			
Potassium nitrate	KNO ₃		<L	<60	S,Q	62		1	Q ₁ (V)	B	P	G	G	6,0		kr	334	400(Z)	2,109
Potassium permanganate E: 93°C; V: 60°C	KMnO ₄ KMnO ₄		<L <L	<80 <Kp	S,Q S,Q	62 62		1 1	Q ₁ (V) Q ₁ (V)	B B	E M ₂	G G	G G	Xn,3,0,N Xn,3,0,N		kr	>240(Z)		2,703
Potassium peroxodisulfate (Potassium persulfate)	K ₂ S ₂ O ₈		<20	<60	S,Q	62		1	Q ₁	Q ₁	V	G	G	Xn,Xi,3,0		kr	~100(Z)		2,48
Potassium phosphates			<L	<Kp	S,Q	62		1	Q ₁ (V)	B	V	G	G	3		kr			
Potassium silicates			<20	<Kp	D	53A		1	Q ₁ (S)	B	E	G	G	3,4		kr			
Potassium sulfate	K ₂ SO ₄		<L	<60	S,Q	62		1	Q ₁ (V)	B	V	G	G	3		kr	1069	1689	2,67
Potato mash → Mash																			
Potato scrapings		N	<30	<60	S	02	KD	1	Q ₁ (S)	B	V	G	G			pa			
Potato starch		N	-	<Kp	D	53A		1	Q ₁ (S)	B	V	G	G	3,4					
Propane, liquefied	C ₃ H ₈	TA	-	>-20	S	11		1	Q ₁	A	V	G	G	F+	1000	ga	-187	-42	(+)
Propanediols:																			
1,2-Propanediol (Propylene glycol)	C ₃ H ₈ O ₂		-	<100	S	11		1	Q ₁ (S)	B	V	G	G			fl	-68	188	1,0381
1,3-Propanediol (Trimethylene glycol)	C ₃ H ₈ O ₂		-	<100	S	11		1	Q ₁ (S)	B	V	G	G			fl	-26	214	1,0597
Propanols:																			
1-Propanol (n-Propyl alcohol)	C ₃ H ₇ OH	TA	-	<Kp	S	11		1	Q ₁ (S)	B	E	G	G	F,Xi		fl	-127	97	0,804
2-Propanol (Isopropyl alcohol)	C ₃ H ₇ OH	TA	-	<Kp	S	11		1	Q ₁ (S)	B	E	G	G	F,Xi		fl	-89	82	0,7855
Propene, liquefied	C ₃ H ₆	TA	-	>-20	S	11		1	Q ₁	A	V	G	G	F+		ga	-185	-48	(+)
Propine, liquefied	C ₃ H ₄	TA	-	>-20	S	11		1	Q ₁	A	V	G	G	F+	1000	ga	-103	-23	(+)
Propionaldehyde (Propanal, Propaldehyde)	C ₃ H ₆ O	TA	-	<Kp	S	11		1	Q ₁ (S)	B	M ₁	G	G	F,Xi		fl	-81	49	0,807
Propionic acid	C ₃ H ₆ O ₂		-	<Kp	D	53A		1	Q ₁ (V)	B	M ₂	G	G	C	10	fl	-22	141	0,992
Propyl acetates:																			
1-Propyl acetate (n-Propyl acetate)	C ₆ H ₁₀ O ₂	TA	-	<80	S,Q	62		1	Q ₁ (S)	B	M ₂	G	G	F,Xi	200	fl	-92	102	0,887
2-Propyl acetate (Isopropyl acetate)	C ₆ H ₁₀ O ₂	TA	-	<80	S,Q	62		1	Q ₁ (S)	B	M ₂	G	G	F,Xi	200	fl	-73	90	0,872
Propyl alcohols → Propanols																			
Propylene → Propene																			
Propylene glycols → Propanediols																			
Propylene oxide	C ₃ H ₆ O	TA	-	<Kp	D	53A		1	Q ₁ (S)	B	K	G	G	T,R45,R46,Xi,F+		fl	-112	35	0,83
Prussic acid → Hydrocyanic acid																			
Pulp, cellulose < 1.5 % dry weight < 3 % dry weight > 3 % dry weight				<90 <90 <90	S S S	11 02 02		2 2 3	B Q ₁₂ Q ₁	Q ₁ Q ₁₂ Q ₁	V V V	G G G	G G G						
Pydraul		®	-	<80	S	11		1	Q ₁ (S)	B	E	G	G	U		fl			
Pyridine	C ₅ H ₅ N	TA	-	<40	S,Q	62		1	Q ₁ (S)	B	M ₂	G	G	Xn,F	5	fl	-42	115	0,982
Pyrogallol (Pyrogallic acid)		TA	<L	<100	S,Q	62		1	Q ₁ (V)	B	M ₁	G	G	Xn,3		kr	133...134	309	1,453
Pyrrolidone	C ₄ H ₉ NO		<L Sch	<100 <100	S S			1 1	Q ₁ (S) S	B B	M ₃ M ₃	G G	G G			kr	25	245	1,116
P-3 lye, clean			-	<60	S	11		1	Q ₁ (V)	B	E	G	G			fl			
P-3 lye; containing fats, oils and dirt		V	-	<100	S	11		1	Q ₁	Q ₁	M ₁	G	G			fl			

Q																			
Quench oil		G	-	<200	S	32		1	Q ₁	Q ₁	M ₁	G	G			fl			

Mechanical seal selection by media

Media				Mechanical Seal									Additional information on the medium						
Code of materials and legend see inside of back cover. Please observe the note on page 1.	Chemical formula	Remark	Temp. °C	Arrangement	Auxil. piping	Addit. measures	Seal type	Materials to EN 12756					Hazard warnings	TLV-value	Normal condition	Melting temperature °C	Boiling point °C	Density g/cm ³	
								1	2	3	4	5							
								Seal face	Seal face	Sec. seal	Spring	Others							
								10	11	12	13	14							15
2	3	4	5	6	7	8	9	10	11	12	13	14	15						
R																			
Rapeseed oil → Colza oil																			
Raw juice → Sugar juices																			
'Refrigerant oil' saturated with R...		G	-	<100	S	11		1	Q ₁	A	M ₄	G	G	U	fl				
Refrigerants, DIN 8962																			
R 12B2 (Dibromodifluoromethane)	CBr ₂ F ₂	TA	-	<25	S	11		1	Q ₁	A	M ₁	G	G	Xi	100	fl	-110	23	2,215
R 14 (Tetrafluoromethane)	CF ₄		-	>-40	S	53A		1	Q ₁ (S)	B	M ₄	G	G	1,4	10	ga	-184	-128	(+)
R 21 (Fluorodichloromethane)	CHCl ₂ F	TA	-	>-40	D	53A		1	Q ₁ (S)	B	M ₄	G	G	N,1,4	V	ga	-135	9	(+)
R 22 (Chlorodifluoromethane)	CHClF ₂	TA	-	>-40	D	53A		1	Q ₁ (S)	B	M ₄	G	G	N,1,4		ga	-160	-41	(+)
R 23 (Trifluoromethane)	CHF ₃	TA	-	>-40	D	53A		1	Q ₁ (S)	B	M ₄	G	G	1,4		ga	-155	-82	(+)
R 32 (Difluoromethane)	CH ₂ F ₂	TA	-	>-40	D	53A		1	Q ₁ (S)	B	M ₄	G	G	F+,1,4		ga	-136	-52	(+)
R 116 (Hexafluoroethane)	CF ₆	TA	-	>-40	D	53A		1	Q ₁ (S)	B	M ₄	G	G	1,4		ga	-101	-78	(+)
R 133a (2-Chloro-1,1,1-trifluoroethane)	CH ₂ ClF ₃	TA	-	>-40	D	53A		1	Q ₁ (S)	B	M ₄	G	G	N,1,4		ga	-105	6	(+)
R 142b (1-Chloro-1,1-difluoroethane)	CH ₃ ClF ₂	TA	-	>-40	D	53A		1	Q ₁ (S)	B	M ₄	G	G	1,4,F+,N	1000	ga	-131	-10	(+)
R 143a (1,1,1-Trifluoroethane)	C ₂ H ₃ F ₃	TA	-	>-40	D	53A		1	Q ₁ (S)	B	M ₄	G	G	1,4,F+		ga	-111	-47	(+)
R 152a (1,1-Difluoroethane)	F ₂ HCCH ₃	TA	-	>-40	D	53A		1	Q ₁ (S)	B	M ₄	G	G	F+,1,4		ga	-117	-25	(+)
R 218 (Octafluoropropane)	C ₃ F ₈	TA	-	>-40	D	53A		1	Q ₁ (S)	B	M ₄	G	G	1,4		ga	-183	-37	(+)
R 610 (Decafluorobutane)	C ₄ F ₁₀	TA	-	>-40	D	53A		1	Q ₁ (S)	B	M ₄	G	G	1,4		ga	-127	20	-2 (+)
R 1112a			-	<20	S	11		1	Q ₁	B	M ₄	G	G			fl	-127	20	1,555
			-	>20	D	53A		1	Q ₁ (S)	B	M ₄	G	G	1,4					
R 1113 (Chlorotrifluoroethylene)	CClF ₃	TA	-	>-40	D	53A		1	Q ₁ (S)	B	M ₄	G	G	T,1,4,F+		ga	-158	-28	(+)
R 1122 (Chlorodifluoroethylene)	CHClF ₂	TA	-	>-40	D	53A		1	Q ₁ (S)	B	M ₄	G	G	1,4,F+,N		ga	-138	-18	(+)
R 1132a (1,1-Difluoroethylene)	C ₂ H ₂ F ₂	TA	-	>-40	D	53A		1	Q ₁ (S)	B	M ₄	G	G	Xn,R40,1,4,F+		ga	-144	-86	(+)
RC 318 (Octafluorocyclobutane)	C ₄ F ₈	TA	-	<-40	D	53A		1	Q ₁ (S)	B	M ₄	G	G	1,4		ga	-41	-6	(+)
Rinsing agent (industrial)			-	<100	S	11		1	Q ₁ (S)	B	M ₄	G	G						
					<80	S	S	1	Q ₁ (S)	B	M ₄	G	G						
S																			
Saccharose (sugar)	C ₁₂ H ₂₂ O ₁₁		<L	<Kp	D	53A		1	Q ₁ (S)	B	V	G	G	3,4		kr	185...186		1,588
Salicylic acid	C ₇ H ₆ O ₃		<L	<25	S	11		1	Q ₁ (V)	B	E	G	G	Xn		kr	157...159	211(27)	1,44
	C ₇ H ₆ O ₃		Sch	<180	S	53A	(H)	1	Q ₁ (V)	B	M ₂	G	G	Xn,2,3					
Salmiac → Ammonium chloride																			
Salt mashes → Mashes																			
Santotherm → Heat transfer oils		®																	
Sea water → Water																			
Sewage sludge		G		<80	S	32		1	Q ₁	Q ₁	V	G	G			pa			
Sewage water → Water																			
Shampoo → Hair shampoos																			
Silicon chlorides:																			
Disilicon hexachloride (Hexachlorodisilane)	Si ₂ Cl ₆		-	<Kp	D	53A		1	Q ₁ (V)	B	M ₁	G	G	C,3		fl	-1	147	1,58
Silicon tetrachloride (Tetrachlorosilane)	SiCl ₄		-	<Kp	D	53A		1	Q ₁ (V)	B	M ₁	G	G	Xi,3		fl	-70	57	1,483
Silicones, silicone oils			-	<100	S	11		1	Q ₁ (S)	B	E	G	G			fl			
Silver nitrate	AgNO ₃		<L	<Kp	S,Q	62		1	Q ₁	Q ₁	M ₂	G	G	C,N		kr	212	>250(Z)	4,352
Skin creams		G	-	<60	S	11		1	Q ₁ (S)	B	V	G	G			pa			
Skydrol → Hydraulic fluids HFC		®																	
Soap solution			-	<Kp	S	11		1	Q ₁ (S)	B	V	G	G			fl			
Soda → Sodium carbonate																			
Soda lye → Caustic soda solution																			
Sodium acetate	C ₂ H ₃ NaO ₂		<L	<Kp	S	11		1	Q ₁ (V)	B	M ₂	G	G			kr	58	324(Z)	1,54
Sodium bi ... → Sodium hydrogen ...																			
Sodium bleaching lye → Sodium hypochlorite																			
Sodium carbonate (Soda)	Na ₂ CO ₃		<L	<80	S,Q	62		1	Q ₁ (S)	B	E	G	G	Xi,4		kr	854	>400(Z)	2,532
Sodium chlorate	NaClO ₃		<L	<Kp	D	53A		1	Q ₁ (V)	B	M ₁	G	G	Xn,3,0,N		kr	255(Z)		2,49

Media				Mechanical Seal										Additional information on the medium						
Code of materials and legend see inside of back cover. Please observe the note on page 1.	Chemical formula	Remark	Concentration %	Temp. °C	Arrangement	Auxil. piping	Addit. measures	Seal type	Materials to EN 12756					Hazard warnings	TLV-value	Normal condition	Melting temperature °C	Boiling point °C	Density g/cm ³	
									1	2	3	4	5							
									Seal face	Seal face	Sec. seal	Spring	Others							
1	2	3	4	5	6	7	8	9	10	11	12	13	14	15						
Sodium chloride	NaCl		<L	<80	S,Q	11		5	Q ₁	Q ₁	E	M	M			kr	801	1461	2,164	
	NaCl		<5	<30	S	11		1	Q ₁ (V)	B	E	G	G							
Sodium chlorite	NaClO ₂		<L	<25	S	11		5	Q ₁	Q ₁	V	G	G	T,O		kr	>150(Z)			
Sodium cyanide	NaCN		<L	<Kp	D	53A		1	Q ₁ (V)	B	M ₂	G	G	T+,N	5	kr	564	1496	1,546	
Sodium dichromate (VI)	Na ₂ Cr ₂ O ₇		<L	<Kp	D	53A		1	Q ₁ (V)	B	M ₁	G	G	C,T+,Xn,R45,R46,O,N	*	kr	357	>400(Z)	2,52	
Sodium disulfite	Na ₂ S ₂ O ₅		<L	<100	S	11		5	Q ₁	Q ₁	V	G	G	Xn,Xi		kr	>150(Z)		1,48	
Sodium dithionite	Na ₂ S ₂ O ₄		<L	<60	S,Q	62		5	Q ₁	Q ₁	E	G	G	Xn,3		kr	>100(Z)		2,37	
Sodium hydrogen carbonate (Bicarbonate of sodium, Sodium bicarbonate)	NaHCO ₃		<L	<60	S	11		5	Q ₁	Q ₁	E	G	G			kr	270(Z)		2,22	
Sodium hydrogen sulfate	NaHSO ₄		<L	<Kp	S	11		5	Q ₁	Q ₁	V	G	G	Xi		kr	>315(Z)		2,103	
Sodium hydrogen sulfide	NaHS		<L	<Kp	D	53A		1	Q ₁ (V)	B	V	G	G	T,3		kr	350		1,79	
Sodium hydrogen sulfite = aqueous solution of → Sodium disulfite																				
Sodium hydrosulfate → Sodium hydrogen sulfate																				
Sodium hydroxide → Caustic soda solution																				
Sodium hypochlorite (Chlorine bleaching lye)	NaOCl		<L	<30	S	11		1	Q ₁	Q ₁	M ₂	M	M	C,N		kr				
Sodium metaaluminate	NaAlO ₂		<L	<60	S	11		5	Q ₁	Q ₁	E	G	G	C		kr	1650			
Sodium nitrate	NaNO ₃		<L	<80	S	11		1	Q ₁ (S)	B	E	G	G	O		kr	307	380(Z)	2,261	
Sodium nitrite	NaNO ₂		<L	<Kp	D	53A		1	Q ₁ (V)	B	M ₂	G	G	T,3,O,N		kr	271	>320(Z)	2,17	
Sodium perborate	NaBO ₃ ·4H ₂ O NaBO ₃ ·4H ₂ O		<10	<25	S,Q	62		5	Q ₁	Q ₁	E	G	G	Xn,3,6,0		kr	>60(Z)		1,731	
Sodium perchlorate	NaClO ₄		<L	<Kp	D	53A		1	Q ₁ (V)	B	M ₂	G	G	Xn,2,3,6,0		kr	482(Z)		2,50	
Sodium peroxide (Sodium superoxide)	Na ₂ O ₂		<L	<Kp	D	53A		1	Q ₁	Q ₁	M ₂	G	G	C,2,3,0		kr	460	657(Z)	2,8	
Sodium phosphates			<L	<Kp	S,Q	62		5	Q ₁	Q ₁	E	G	G	3,6		kr	1018		1,39	
Sodium silicate (Water glass)			<L	<Kp	D	53A		1	Q ₁ (S)	B	E	G	G	Xi,3,4		kr				
Sodium sulfate (Glauber's salt)	Na ₂ SO ₄		<L	<80	S,Q	62		1	Q ₁ (V)	B	P	G	G	3		kr	888		2,68	
Sodium sulfite	Na ₂ SO ₃		<L	<Kp	S	11		5	Q ₁	Q ₁	E	G	G			kr	150		2,633	
Sodium thiocyanate	NaSCN		<L	<Kp	D	53A		1	Q ₁ (V)	B	E	G	G	Xn	5	kr	287		1,73	
Sodium thiosulfate	Na ₂ S ₂ O ₃ ·5H ₂ O		<L	<80	S,Q	62		1	Q ₁ (V)	B	E	G	G	3		kr	48		1,73	
Soft soap			-	>F<100	S	11		1	Q ₁ (S)	B	V	G	G			pa				
Softener → Phthalic acid esters																				
Soiled water → Water																				
Soot-water mixture			<10	<Kp	S	11		1	U ₁	U ₁	V	G	G			fl				
Soybean oil		N	-	<100	S	11		1	Q ₁ (S)	B	V	G	G			fl	-16...-10		0,92	
Spinach mash		N	-	<80	S	11		1	Q ₁ (S)	B	V	G	G			pa				
Spirits of salmiac → Ammonia aqu. Solutions																				
Spirit of wine → Ethanol																				
Spirit → Ethanol																				
Steam	H ₂ O		-	<180	D	53A		1	Q ₁ (S)	B	E	G	G	1		fl		100		
Stearic acid (Octadecanoic acid)	C ₁₈ H ₃₆ O ₂		Sch	<130	S	11		1	Q ₁ (V)	B	M ₂	G	G			fe	69	370	0,94	
Strontium chloride	SrCl ₂		<L	<Kp	D	53A		1	Q ₁ (V)	B	M ₁	G	G	Xn,2		kr	872		3,094	
Strontium nitrate	Sr(NO ₃) ₂		<L	<Kp	D	53A		1	Q ₁ (V)	B	M ₂	G	G	Xi,2,0		kr	570		2,93	
Styrene (Vinylbenzene, Phenylethylene)	C ₈ H ₈		-	<80	S,Q	53A		X	Q ₁ (S)	B	M ₁	G	G	Xn,Xi,3,4	20	fl	-33	146	0,909	
Succinic acid	C ₄ H ₆ O ₄		<L	<Kp	S	11		1	Q ₁ (S)	B	M ₁	G	G	Xi		kr	186	235	1,56	
Sugar juices (conc. data in Brix): Raw juice Thick juice Thin juice	Clairce juice		>70 <20 >70 <20	<95 <70 <95 <100	D D D D	53A 11 53A 11		1 1 1 2	Q ₁₂ Q ₁₂ Q ₁₂ Q ₁₂	V V V V	G G G G	G G G G								
Sulfamic acid → Amidosulfuric acid																				
Sulfite lye → Calcium hydrogen sulfite																				
Sulfolan → Tetrahydro- thiophene-1,1-dioxide																				
Sulfur chlorides: Disulfur dichloride	S ₂ Cl ₂		-	<Kp	D	53A		1	Q ₁ (V)	B	M ₁	G	G	T,C,2,N	1	fl	-80	136	1,678	
Sulfur dichloride	SCl ₂		-	<Kp	D	53A		1	Q ₁ (V)	B	M ₁	G	G	C,2,N		fl	-122	59	1,621	
Sulfur dioxide	SO ₂		-	<80	D	53A		1	Q ₁ (V)	B	E	G	G	T,1	2	ga	-75	-10	(+)	

Mechanical seal selection by media

Media				Mechanical Seal								Additional information on the medium							
Code of materials and legend see inside of back cover. Please observe the note on page 1.	Chemical formula	Remark	Concentration %	Temp. °C	Arrangement	Auxil. piping	Addit. measures	Seal type	Materials to EN 12756					Hazard warnings	TLV-value	Normal condition	Melting temperature °C	Boiling point °C	Density g/cm ³
									1	2	3	4	5						
									Seal face	Seal face	Sec. seal	Spring	Others						
1	2	3	4	5	6	7	8	10	11	12	13	14	15						
Sulfur fluorides:																			
Disulfur decafluoride (Sulfur pentafluoride)	S ₂ F ₁₀	-	<Kp	S,Q	62			1	Q ₁ (V)	B	M ₂	G	G			fl	-92	29	2,08(0)
Disulfur difluoride (Thiothionylfluoride)	S ₂ F ₂	-	<60	D	53A			1	Q ₁ (V)	B	M ₂	G	G	1	0,025	ga	-164	~-11	(+)
Sulfur hexafluoride	SF ₆	-	<60	D	53A			1	Q ₁ (V)	B	M ₂	G	G	1	1000	ga	-51	-64(S)	(+)
Sulfur tetrafluoride	SF ₄	-	<60	D	53A			1	Q ₁ (V)	B	M ₂	G	G	T+,C,1		ga	-121	-40	(+)
Sulfur tetrafluoride → Sulfur fluorides																			
Sulfur trioxide (molten or gaseous)																			
	SO ₃	-	>F<160	D	54			1	Q ₁	Q ₁	M ₁	G	G	C,1,2,3,4		kr	17...62	45	1,97...2,00
Sulfur, molten																			
	S	Sch	<220	S	01	(H)		6	A	Q ₁	U ₁	M ₆	G ₁	F		kr	110...119	444	1,96...2,07
	S	Sch	<200	S	01	H		1	Q ₁	A	M ₁	G	G						
Sulfuric acid																			
	H ₂ SO ₄	<10	<30	S,Q	62			1	Q ₁ (V)	B	V	G	G	Xi			5% -2	5% 101	5% 1,032
	H ₂ SO ₄	<10	<30	S,Q	62			1	Q ₁ (V)	B	M ₁	M	M	Xi,2			10% -5	10% 102	10% 1,066
	H ₂ SO ₄	<20	<30	S,Q	62			1	Q ₁ (V)	B	M ₁	M	M	C,2			20% -14	20% 105	20% 1,139
	H ₂ SO ₄	<96	<30	S,Q	62			1	Q ₁ (V)	B	V	M	M	C,2			40% -68	40% 113	40% 1,303
	H ₂ SO ₄	>80	<30	S,Q	62			1	Q ₁	Q ₁	V	G	G	C			60% -29	60% 140	60% 1,498
	H ₂ SO ₄	>90	<30	S,Q	62			1	Q ₁	Q ₁	V	G	G	C			80% -1	80% 205	80% 1,727
	H ₂ SO ₄	>90	<30	S,Q	62			1	Q ₁	Q ₁	M ₁	M	M	C,2			96% -11	96% 310	96% 1,835
	H ₂ SO ₄	>90	<20	S,Q	62			1	Q ₁	Q ₁	M ₁	M	M	C,2			98% +2	98% 330	98% 1,836
Sulfuric acid, fuming (= Oleum = conc. H ₂ SO ₄ + free SO ₃)																			
	H ₂ SO ₄ +SO ₃	<40	<30	S,Q	62			4	Q ₁	Q ₁	M ₁	M	M						40%~100
	H ₂ SO ₄ +SO ₃	<60	<30	S,Q	62			1	Q ₁	Q ₁	M ₁	M	M	C,Xi					60%~70
Sulfurous acid (aqueous solution of SO ₂)																			
	H ₂ SO ₃	<L	<Kp	S,Q	62			1	Q ₁ (V)	B	M ₂	M	M			fl			
	H ₂ SO ₃	<L	<20	S,Q	11			1	Q ₁ (V)	B	E	G	G	C,2					
Synthetic resin laquers and glues																			
		S	-	<Kp	D	53A		1	Q ₁ (S)	B	M ₁	G	G	3,4		fl			

T																			
Table salt → Sodium chloride																			
Table vinegar → Acetic acid																			
Tall oil fatty acids																			
		Sch	<200	S,Q	62			1	Q ₁	A	M ₁	M	M	3			fe		
		Sch	>200	S,Q	62			6	A	Q ₁	M ₁	M ₅	M	3					
Tall oil pitch																			
		Sch	<150	S,Q	62			1	Q ₁	A	M ₁	M	G	Xi,3			fe		
Tall oil resin (acids)																			
		Sch	<200	S,Q	62			1	Q ₁	A	M ₁	M	M	3			fe		
		Sch	>200	S,Q	62			6	A	Q ₁	G	M ₅	M	3					
Tall oil, crude																			
		Sch	<120	S,Q	62			1	Q ₁	A	M ₁	G	G	3			pa		0,95
Tallow																			
		Sch	<100	S	11			1	Q ₁ (S)	B	V	G	G				fe	40...70	
Tannery waste water, pH = 9 - 11																			
		-	<40	S	11			1	Q ₁ (V)	B	V	G	G				fl		
Tannic acids → Tannines																			
Tannines (natural Polyphenols)																			
		G	<L	<100	S	11		1	Q ₁ (S)	B	V	G	G				fe		
Tar, tar oil → Coal tar																			
Tartaric acid																			
		<L	<60	S	11			1	Q ₁ (S)	B	V	G	G	Xi			kr	~170	1,76...1,79
Taurine (2-Aminoethanesulfonic acid)																			
	C ₂ H ₇ NO ₃ S	<L	<80	S	11			1	Q ₁	B	M ₁	G	G	Xi			kr	328(Z)	
Terphenyls (diphenyl benzenes):																			
m-Terphenyl (1,3-Diphenyl benzene)																			
	C ₁₈ H ₁₄	Sch	<180	S,Q	62	(H)		1	Q ₁ (S)	B	M ₁	G	G	Xi,3			kr	89	365
o-Terphenyl (1,2-Diphenyl benzene)																			
	C ₁₈ H ₁₄	Sch	<180	S,Q	62	(H)		1	Q ₁ (S)	B	M ₁	G	G	Xn,3			kr	57...58	332
p-Terphenyl (1,4-Diphenyl benzene)																			
	C ₁₈ H ₁₄	Sch	<Kp	S,Q	62	(H)		6	A	Q ₁	G	M ₆	T4	Xi,3			kr	213	404
Tetrabromoethane (Acetylene tetrabromide)																			
	C ₂ H ₂ Br ₄	TA	-	<160	D	53A		1	Q ₁ (V)	B	M ₁	G	G	T+,Xi			1	fl	0
Tetrachloroethane (Acetylene tetrachloride)																			
	C ₂ H ₂ Cl ₄	TA	-	<Kp	D	53A		1	Q ₁ (V)	B	M ₁	G	G	T+,N			1	fl	-42
Tetrachloroethylene (Perchloroethylene)																			
	C ₂ Cl ₄	TA	-	<60	S	11		1	Q ₁ (S)	B	M ₁	G	G	Xn,R40,N			50	fl	-23
Tetrachloroethylene, contaminated																			
		TA	-	<60	S	11		1	Q ₁ (V)	B	M ₁	G	G	Xn,R40,N					
Tetrachloromethane → Carbon tetrachloride																			
Tetraethylene glycol → Ethylene glycols																			
Tetrahydrofuran (Tetramethylene oxide, Oxolane)																			
	C ₄ H ₈ O	TA	-	<40	S,Q	62		1	Q ₁ (V)	B	M ₂	G	G	Xi,F,6			200	fl	-108

Media				Mechanical Seal									Additional information on the medium							
Code of materials and legend see inside of back cover. Please observe the note on page 1.	Chemical formula	Remark	Temp. °C	Arrangement	Auxil. piping	Addit. measures	Seal type	Materials to EN 12756					Hazard warnings	TLV-value	Normal condition	Melting temperature °C	Boiling point °C	Density g/cm ³		
								1	2	3	4	5								
								Seal face	Seal face	Sec. seal	Spring	Others								
1	2	3	4	5	6	7	8	9	10	11	12	13	14	15						
Tetrahydrothiophene-1,1-dioxide ('Sulfolan')	C ₄ H ₈ O ₂ S		Sch	<60	S	11	(H)	1	Q ₁ (V)	B	M ₁	G	G	Xn		kr	27	285	1,26	
Thick juice → Sugar juices																				
Thick liquor (Sulfite chemical pulp)		G	-	<Kp	D	53A		1	Q ₁ (V)	B	M ₁	G	G							
Thin juice → Sugar juices																				
Thiols		G	-	<Kp	D	53A		1	Q ₁ (V)	B	M ₁	G	G	U	0,5	fl				
Thiothionyl fluoride → Sulfur fluorides																				
Throat gas → Blast furnace gas																				
Titanium chlorides:																				
Titanium(IV) chloride (Titanium tetrachloride)	TiCl ₄		-	<Kp	D	53A		1	Q ₁ (V)	B	M ₁	G	G	C,2,3		fl	-25	136	1,726	
Titanium(III) chloride (Titaniumtrichloride)	TiCl ₃		<L	<Kp	D	53A		1	Q ₁ (V)	B	M ₁	G	G	C,2,3,F		kr	440(Z)		2,64	
Titanium dioxide – Solution in sulfuric acid	TiO ₂		<L	<180	S	02	kD	X	Q ₁	Q ₁	T	M	G	C,2						
Titanium dioxide – Suspension in water			<40	<Kp	S,Q	53A		X	U ₂	Q ₁ (V)	E	G	G	4		kr	>1800		3,9...4,26	
Tobacco emulsion			-	<60	S	11		1	Q ₁	Q ₁	V	G	G			fl				
Toluene	C ₇ H ₈	TA	-	<60	S	11		1	Q ₁ (S)	A	K	G	G	Xn,Xi,R63,F	100	fl	-95	111	0,866	
Tomato juice → Ketchup																				
Tooth pastes		G	-	<40	S	11		1	Q ₁	Q ₁	V	G	G			pa				
Tributyl phosphat (TBP, Phosphoric acid tributyl ester)	C ₁₂ H ₂₇ O ₄ P	TA	-	<60	S	11		1	Q ₁ (V)	B	M ₁	G	G	Xn,Xi,R40		fl	-79	293	0,979	
Trichloroacetic acid (TCA)	C ₂ HCl ₃ O ₂	TA	Sch	<Kp	D	53A	SW,H	1	Q ₁ (V)	B	M ₂	G	G	C,2,3,N		kr	59	198	1,63(60)	
Trichloroborane → Boron trichloride																				
1,1,2-Trichloroethane	C ₂ H ₃ Cl ₃	TA	-	<60	S,Q	62		1	Q ₁ (V)	B	M ₁	G	G	Xn,R40	10	fl	-35	113...114	1,4416	
Trichloroethylene	C ₂ HCl ₃	TA	-	<25	S	11		1	Q ₁ (V)	B	V	G	G	T,Xi,R45	50	fl	-86	87	1,4649	
	C ₂ HCl ₃	TA	-	<60	S,Q	62		1	Q ₁ (S)	B	M ₁	G	G	T,Xi,R45,6						
Trichloronitromethane (Chloropicrine)	CCl ₃ NO ₂	TA	-	<60	S,Q	62		1	Q ₁ (V)	B	M ₁	G	G	T+,Xi,6	0,1	fl	-64	112	1,6566	
Tricresyl phosphate (TCP)	C ₂₁ H ₂₁ O ₄ P	TA	-	<100	S	11		1	Q ₁ (S)	B	M ₂	G	G	T,N		fl	-28	435	1,17...1,18	
Triethanolamine	C ₆ H ₁₅ NO ₃		-	<60	S	11		1	Q ₁ (S)	B	M ₂	G	G			fl	21	360	1,1242	
Triethylamine	C ₆ H ₁₅ N	TA	-	<60	S,Q	62		1	Q ₁ (S)	B	M ₂	G	G	Xn,C,F	10	fl	-115	89	0,728	
Triethylene glycol → Ethylene glycols																				
Trifluoroborane → Boron trifluoride																				
Triglycol → Ethylene glycols																				
Trisodium phosphate → Sodium phosphates	S																			
Tung oil → Wood oil																				
Turbine oils			-	<100	S	11		1	Q ₁ (S)	B	V	G	G	U		fl				
Turkey red oil			-	<140	S	11		1	Q ₁ (S)	B	M ₁	G	G			fl			1,03	
Turpentine, oil		TA,G	-	<60	S	11		1	Q ₁ (S)	B	V	G	G	Xn,Xi,R46,N	100	fl		155...180	0,85...0,87	
Tutogen		®	-	<60	S	11		1	Q ₁ (S)	B	V	G	G			fl				

U																			
Urea (Carbamide)	CH ₄ N ₂ O CH ₂ N ₂ O		<L <L	<100 <100	D D	53A 53A		1 5	Q ₂₂ Q ₁	Q ₁ (V) Q ₁	E E	G G	G G	3,4 3,4		kr	132		1,323
Urea nitrate	CH ₅ N ₃ O ₄		<10	<60	S	11		1	Q ₁	Q ₁	M ₂	G	G			kr	152(Z)		1,69
Urea phosphate	CH ₇ N ₂ O ₅ P		<10	<60	S	11		1	Q ₁	Q ₁	M ₂	G	G	Xi		kr	119		
Urea resins (DIN 7728: abbr. UF)		G	-	<100	D	53A		1	Q ₂₂	Q ₁ (V)	M ₂	G	G	3,4		pa			
Urine			-	<40	S	11		5	Q ₁	Q ₁	E	G	G			fl			

Mechanical seal selection by media

Media				Mechanical Seal										Additional information on the medium					
Code of materials and legend see inside of back cover. Please observe the note on page 1.	Chemical formula	Remark	Concentration %	Temp. °C	Arrangement	Auxil. piping	Addit. measures	Seal type	Materials to EN 12756					Hazard warnings	TLV-value	Normal condition	Melting temperature °C	Boiling point °C	Density g/cm ³
									1	2	3	4	5						
									Seal face	Seal face	Sec. seal	Spring	Others						
1	2	3	4	5	6	7	8	9	10	11	12	13	14	15					

V																		
Varnishes		G	-	TG	D	53A		1	Q ₁ (V)	B	M ₁	G	G	3,4		fl		
Vaseline → <i>Petrolatum</i>																		
Vegetable oils		G	0	<150	S	11		1	Q ₁ (S)	B	V	G	G			fl		
Vegetable mash			-	<100	S	11		1	Q ₁ (S)	B	V	G	G			pa		
Vinyl acetate → <i>Acetic acid vinyl ester</i>																		
Vinyl acetylene (Butenyne)	C ₄ H ₄	TA	-	<60	D	53A		1	Q ₁ (V)	B	M ₂	G	G	1,3		ga	-92	5 (+)
Vinylbenzene → <i>Styrene</i>																		
Vinyl chloride	C ₂ H ₃ Cl	TA	-	<40	D	53A		1	Q ₁ (V)	B	M ₁	G	G	T,R45,F+,1	*	ga	-154	-14 (+)
Vinylidene chlorides → <i>Dichloroethenes</i>																		
Volatile oils		S	-	<Kp	S	11		1	Q ₁ (S)	B	M ₁	G	G	U		fl		

W																		
Walnut oil		N	-	<100	S	11		1	Q ₁ (S)	B	V	G	G			fl		~0,92
Washing lye		S	-	<Kp	S	11		1	Q ₁ (S)	B	M ₁	G	G			fl		
Washing lye, dirty		S	-	<Kp	S	11		1	Q ₁	Q ₁	M ₁	G	G			fl		
Wastewater → <i>Water</i>																		
Water from pressed fish		N	Sus	<60	S	02		1	Q ₁	Q ₁	V	G	G			fe		
Water glass → <i>Sodium silicates</i>																		
Water vapour (Steam)	H ₂ O		-	<180	D	53A		1	Q ₁ (S)	B	E	G	G	1				
Water:	H ₂ O																	
Wastewater, sewage water, pH>6<10			-	<50	S	11		1	Q ₁	Q ₁	P	G	G			fl		
Wastewater, sewage water, pH>3<10			-	<50	S	11		5	Q ₁	Q ₁	V	G	G			fl		
Drinking water, industrial water			-	<50	S	11		1	Q ₁ (S)	B	E	G	G			fl		
Drinking water, industrial water			-	<100	S	11		1	Q ₁ (S)	B	E	G	G			fl		
Hot water with additives Boiler feed water Sea and brackish water			-	<50	S	11		5	A	Q ₁	V	M	M			fl		
Waxes		S	-	>F<180	S	11		1	Q ₁ (S)	B	V	G	G			pa		
Whale oil		N	-	<100	S	11		1	Q ₁ (S)	B	V	G	G			fl		
Whey		N	-	<60	S	11		1	Q ₁ (S)	B	V	G	G			fl		
Whiskey			-	<30	S	11		1	Q ₁ (V)	B	E	G	G			fl		
White spirit		TA	-	<60	S	11		1	Q ₁ (S)	B	V	G	G	Xn,N		fl	<-15	153...198
Wine			-	<40	S	11		1	Q ₁ (S)	B	P	G	G			fl		
Wine vinegar → <i>Acetic acid</i>																		
Wood oil (Tung oil)		N	-	<80	S	11		1	Q ₁ (S)	B	V	G	G	Xi		fl	<0	0,89...0,93
Wood pulp, ground pulp → <i>Pulp, (cellulose)</i>																		
Wood spirit → <i>Methanol</i>																		
Wood tar		G	-	<100	S	11		1	Q ₁ (S)	B	M ₁	G	G	U		fl		0,90...1,11
Wood turpentine oil → <i>Tall oil</i>																		

As compositions and applications vary considerably, a general recommendation would not be adequate. Please contact EagleBurgmann.

X																		
Xanthogenates		S	<10	<60	D	53A		1	Q ₁	Q ₁	M ₁	G	G	3,4		kr		
Xenon	Xe		-	<40	D	53A		1	Q ₁ (S)	B	P	G	G	1		ga	-112	-108 (+)
Xylenes (Dimethylbenzenes): technical Xylene (mixture)	C ₈ H ₁₀		-	<60	S	11		1	Q ₁ (S)	B	M ₁	G	G	Xn, Xi	100	fl	-63	137...140 ~0,86
m-Xylene	C ₈ H ₁₀		-	<60	S	11		1	Q ₁ (S)	B	M ₁	G	G	Xn, Xi	100	fl	-48	139 0,866
o-Xylene	C ₈ H ₁₀		-	<60	S	11		1	Q ₁ (S)	B	M ₁	G	G	Xn, Xi	100	fl	-25	144 0,881
p-Xylene	C ₈ H ₁₀		-	<60	S	11		1	Q ₁ (S)	B	M ₁	G	G	Xn, Xi	100	fl	13	138 0,861

Media				Mechanical Seal							Additional information on the medium							
Code of materials and legend see inside of back cover. Please observe the note on page 1.	Chemical formula	Remark	Temp. °C	Arrangement	Auxil. piping	Addit. measures	Seal type	Materials to EN 12756					Hazard warnings	TLV-value	Normal condition	Melting temperature °C	Boiling point °C	Density g/cm ³
								1	2	3	4	5						
								Seal face	Seal face	Sec. seal	Spring	Others						
1	2	3	4	5	6	7	8	9	10	11	12	13	14	15				

Y																	
Yeast mash		N	-	<60	S	11		1	Q ₁ (S)	B	V	G	G			pa	
Yoghurt with fruits etc.		N	-	<60	S	11		5	Q ₁	Q ₁	V	G	G			pa	
Yoghurt without fruits etc.		N	-	<60	S	11		1	Q ₁	B	V	G	G			pa	

Z																	
Zapon lacquer		TA	-	<60	D	53A		1	Q ₁ (V)	B	M ₁	G	G	Xn,3,4,F,N		fl	
Zinc chloride	ZnCl ₂		<L	<25	S	11		5	Q ₁	Q ₁	V	G	G	C,Xn,4,6,N		kr	318
	ZnCl ₂		<L	<Kp	D	53A		1	Q ₁ (V)	B	M ₁	G	G	C,Xn,2,4,N			
Zinc cyanide (suspension)	Zn(CN) ₂		<20	<Kp	S	02	kD	3	Q ₁	Q ₁	P	G	G	T+,N		kr	~800(Z)
Zinc nitrate	Zn(NO ₃) ₂ *6H ₂ O		<L	<60	S,Q	62		5	Q ₁	Q ₁	V	G	G	Xn,6,0		kr	36
Zinc oxide (suspension)	ZnO		<50	<Kp	S,Q	53A	kD	3	Q ₁	Q ₁	V	G	G	3,4,N	5 mg	kr	1975
Zinc paints, water soluble			<L	<60	S,Q	62		5	Q ₁	Q ₁	V	G	G	6		fl	
Zinc phosphate	Zn ₃ (PO ₄) ₂		<10	<100	D	53A		1		B	M ₁	G	G	3,4,N		kr	>900
Zinc sulfate (Zinc vitriol)	Zn ₂ SO ₄ *7H ₂ O		<L	<60	S,Q	62		5	Q ₁	Q ₁	V	G	G	Xn,6,N		fe	100
																	1,97

Additional EagleBurgmann product lines

Mechanical seals



Mechanical seals for pumps

EagleBurgmann offers a complete range of liquid and gas-lubricated pump shaft seals including standard and engineered seals in single and multi-seal versions. We also offer a complete range of solutions for all API 682 categories and arrangements. The portfolio includes a broad selection of material and surface technologies such as DiamondFace coatings.

Cartridge seals

- Easy to install
- Inboard/outboard variants
- For all standard modes of circulation
- O-ring, metal bellows and elastomer bellows seals
- Gas-lubricated versions
- Special versions, e.g. for sterile applications
- Split versions available
- Diameter: 20 ... 110 (250) mm (0.79" ... 4.33 (9.84)")
- Pressure: ... 42 (150) bar (... 609 (2,175) PSI)
- Temperature: -40 °C ... +220 °C (-40 °F ... +428 °F)

Elastomer bellows seals

- Compact design
- Straightforward installation
- Stationary and rotating designs
- Approvals: e.g., FDA, WRAS, KTW, ACS, W270, NST
- Diameter: 6 ... 100 mm (0.24" ... 4")
- Pressure: ... 16 bar (... 230 PSI)
- Temperature: ... +140 °C (... +284 °F)

Component seals

- Designed for universal applications
- Versions for high-viscosity media and media containing solids
- Versions for high-performance pumps
- Diameter: ... 400 mm (... 16")
- Pressure: ... 150 bar (... 2,176 PSI)
- Temperature: -50 °C ... +220 °C (-58 °F ... +428 °F)

Metal bellows seals

- For extreme temperature ranges
- For high-viscosity media and media containing solids
- Diameter: 16 ... 100 mm (0.62" ... 4")
- Pressure: vacuum ... 25 bar (... 363 PSI)
- Temperature: -100 °C ... +400 °C (-148 °F ... +752 °F)

Other sizes and engineered seals on request.

Typical applications:

Centrifugal pumps, positive displacements pumps, high-performance pumps, multi-phase and slurry pumps, circulation pumps, hydraulic pumps



Mechanical seals for agitators

Sealing solutions for normal and sterile applications. The design and selection of materials ensure that the seals are rugged enough to deliver excellent cost and engineering performance in all major applications.

Dry-running agitator seals

- Dry-running, contacting seal faces
- For steel and glass lined vessels
- DIN connections or according to customer request
- No seal supply system needed
- FDA-approved face materials
- Diameter: 25 ... 200 mm (1" ... 7.87")
- Pressure: vacuum ... 6 bar (... 87 PSI)
- Temperature: -20 °C ... +250 °C (-4 °F ... +482 °F)

Gas-lubricated agitator seals

- For steel and glass lined vessels
- DIN connections or according to customer request
- FDA-approved face materials
- Non-contacting operation
- Versions for sterile applications
- Diameter: 40 ... 220 mm (1.58" ... 8.7")
- Pressure: vacuum ... 14 bar (... 203 PSI)
- Temperature: -40 °C ... +250 °C (-40 °F ... +482 °F)

Liquid-lubricated agitator seals

- For steel and glass lined vessels
- DIN connections or according to customer request
- FDA-approved face materials
- Designed for all applications
- Diameter: 15 ... 500 mm (0.59" ... 19.69")
- Pressure: vacuum ... 250 bar (... 3,626 PSI)
- Temperature: -80 °C ... +350 °C (-112 °F ... +662 °F)

Typical applications:

Agitators, mixers, dryers, kneaders, reactors, separators, filters



Mechanical seals for compressors

A complete range of products compressors from a single source. Single, double and tandem versions and tandem seals with intermedia labyrinths available.

DGS series

- Standard product series with a proven track record
- Diameter: 29 ... 264 mm (1.14" ... 10.39")
- Pressure: 0 ... 120 bar (0 ... 1,740 PSI)
- Temperature: -20 °C ... +200 °C (-4 °F ... +392 °F)

PDGS high pressure seals

- Elastomer-free, DLC-coated sliding faces
- Diameter: 29 ... 355 mm (1.14" ... 13.98")
- Pressure: 0 ... 450 bar (0 ... 6,526 PSI)
- Temperature: -170 °C ... +230 °C (-274 °F ... +446 °F)

MDGS series for screw compressors

- Seat materials: ductile steel with DM-TiN coating
- Diameter: 40 ... 280 mm (1.57" ... 8.66")
- Pressure: 0 ... 50 bar (0 ... 725 PSI)
- Temperature: -20 °C ... +200 °C (-4 °F ... +392 °F)

TDGS series for steam turbines

- Metal bellows
- Diameter: 40 ... 140 mm (1.5" ... 5.5")
- Pressure: ... 10 bar (... 145 PSI)
- Temperature: -50 °C ... +450 °C (-58 °F ... +842 °F)

Separation seals CSR and CSE

- Very low gas consumption
- Diameter: 29.5 ... 379.5 mm (1.16" ... 14.94")

CobaSeal separation seal

- Insensitive to oil contamination
- Low N₂ consumption
- Face materials: ductile steel with special EagleBurgmann high performance iDLC coating
- Diameter: 29.5 ... 210 mm (1.16" ... 8.27")
- Pressure: 0 ... 15 bar (0 ... 218 PSI)
- Temperature: -20 °C ... +50 °C (-4 °F ... +122 °F)

WRS oil-lubricated seals

- Optimized design due to FEM and computational fluid dynamics
- Diameter: 30 ... 300 mm (1.18" ... 11.81")
- Pressure: ... 50 bar (725 PSI)
- Temperature: -20 °C ... +200 °C (-4 °F ... +392 °F)

Typical applications:

Centrifugal compressors, expanders, turbines, integrally geared compressors, screw compressors, roots compressors, special machines

For detailed information please inquire.

Additional EagleBurgmann product lines

Magnetic couplings

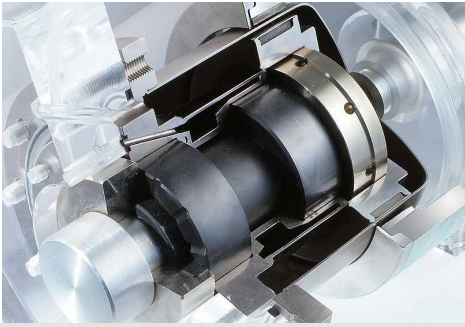

Uncompromising sealing technology for very demanding applications. Hermetically sealed magnetic couplings guarantee leakage-free and maintenance-free pumping and mixing.

The media remains within closed system circulation loops.

MAK series

- Modular design
- Integrated sliding bearing
- Compact dimensions
- Torque transmission ... 462 Nm
- Speed: 3,600 min⁻¹
- Pressure: ... 40 bar (... 580 PSI)
- Temperature: ... +250 °C (... +482 °F)
- Versions for sterile agitator applications
- Optional ceramic or carbon PEEK can

NMB high-efficiency series

- Patented laminated can
- Reduced eddy current losses
- Optional sliding bearing
- Torque transmission: ... 1,879 Nm
- Pressure: ... 45 bar (... 653 PSI)
- Temperature: ... +250 °C (... +482° F)

LMF1 Bearing for magnetic couplings

- Sliding bearing with ceramic or carbon materials for the shaft end of magnetic coupled pumps
- Suitable for MAK66, MAK685 and NMB HE magnetic couplings and others
- Self lubrication through pump liquid
- Compact dimensions
- Version for increased usage conditions on request

Typical applications:

Centrifugal pumps, positive displacements pumps, vacuum pumps, agitators, mixers, compressors, blowers, special machines

Seal supply systems



Depending on the design, application and mode of operation, supply systems are required to flush, cool and pressurize mechanical seals and magnetic couplings and provide leakage compensation. EagleBurgmann supplies a complete range of solutions from a single source including design, production, commissioning and service. The portfolio includes a complete range of API compliant supply systems.

Quench systems

- Versions with polyethylene or stainless steel tanks
- API 682 versions
- Circulation of buffer fluid possible

Thermosiphon systems

- Comprehensive modularized product range
- Sterilizable versions
- API 682 versions for Plan 52 and 53A

Heat exchangers

- Comprehensive standard range
- Extremely efficient cooling
- Compact design
- API 682 versions

SPO (SPB/SPC) closed-circuit barrier fluid systems

- Suitable for applications with high pressure
- No connection to nitrogen supply necessary
- API 682 versions

SPA open-circuit buffer/barrier fluid systems

- High cooling capacity
- Combined supply of various seals

SPN refill units

- Manual, automatic and mobile versions

Gas supply systems

- Customized versions for all types and requirements in gas-lubricated mechanical seal applications
- Seal management system
- API 682 / 614

RoTechBooster

- Compact gas supply unit for compressor seals during the slow-roll or shut-down phase

Typical applications:

Liquid and gas lubricated mechanical seals, magnetic couplings

Carbon floating ring seals



Carbon floating ring seals are supplied as maintenance-free compact labyrinth cartridge seals with low leakage. The floating self-adjusting sealing rings provide radial sealing on the shaft with a very small gap. The seal requires no additional lubrication, and it is designed for dry running. Besides pure gas, carbon floating ring seals are also suitable for Atex applications, toxic media, media containing solids, flue gas, dust, powder, vapor, liquid mist, oil mist and penetrating oil.

Espey WD series (split housing)

- Split housing and seal rings allow easy installation
- Pressure: vacuum ... 20 bar (... 290 PSI)
- Shaft diameter: 40 ... 340 mm (1.57" ... 13.39")
- Radial clearance: max. ±5.0 mm (0.2")
- Axial movement: theoretically unlimited
- Temperature: -120 °C ... +800 °C (-184 °F ... +1,472 °F)
- Sliding velocity: 40 ... 150 m/s (131 ... 492 ft/s)

Espey WDK-BHS for bulkhead shaft penetrations

- Split housing and seal rings allow easy installation
- Verified leakage rates
- International type approvals
- Pressure: max. 3 bar (44 PSI)
- Shaft diameter: 40 ... 800 mm (1.57" ... 31.5")
- Radial play: max. 5 mm (0.2")
- Axial movement: theoretically unlimited
- Temperature: max. 225 °C (437 °F)
- Sliding velocity: 40 m/s (131 ft/s)

Special Espey WD series variants

- Seals for top driven agitators and DIN seal chambers
- Blast furnace seals, shaft ... 4,000 mm (... 157.48")
- Seals for mills and centrifuge feed heads

Espey WKA series

- Chamber seal (modular design – can be combined in any order), optional with housing and lid
- Pressure: vacuum ... 250 bar (... 3,626 PSI)
- Shaft diameter: 20 ... 340 mm (0.79" ... 13.39")
- Radial play: max. ± 2.0 mm (0.08")
- Axial movement: theoretically unlimited
- Temperature: -120 °C ... +500 °C (-184 °F ... +932 °F)
- Sliding velocity: 150 ... 240 m/s (492 ... 787 ft/s), depending on type

Espey shaft sleeves

- Metallic or ceramic coating
- One-piece or split design
- Shaft diameter: 45 ... 340 mm (1.77" ... 13.39")
- Temperature: ... +1,000 °C (... +1,832 °F)

Typical applications:

Blowers, compressors, turbines, centrifuges, mills, agitators, dryers, bulkheads, steam turbines, throttle/control valves, gear units, motors

Additional EagleBurgmann product lines

Compression packings



A cost effective and reliable method for sealing pump shafts, valve spindles and rotating shafts in process equipment. Manufactured from a range of material combinations – traditional and innovative – using state-of-the-art production techniques. Supplied in boxed lengths or pre-cut rings. Approvals/certification includes BAM, DVGW, FDA, API, ISO, TA-Luft. Fire-safe, low leakage, low emission and nuclear grades are available with full documentation and certification.

Rotatherm graphite rings

An accepted industry-standard for valves and pumps in high pressure and high temperature service. Manufactured as moulded rings (with and without steel reinforcement) or special seals. Suits all industry applications including the power and nuclear industries. Approvals/certification includes: BAM, DVGW, API, ISO, TA-Luft.

BuraTAL Fugitive emission products

A comprehensive range of low leakage packing sets manufactured in graphite or our unique non-woven materials. All current fugitive emission standards are met with outstanding performance, low friction, ease of installation, and a long service life. Approvals/certification includes: API 622, ISO 15848, TA-Luft.

Burajet Injectable packings

The Burajet Injectable packing system offers a wide range of injectable compounds for pumps, valves, and process equipment. An ideal product for the mining and paper & pulp industries. Approvals/Certification includes: FDA

Buraglas Glass packings

Manufactured from non-ceramic materials and fibres, BuraGlas packings are suitable for sealing of vessels, coal mills, industrial furnaces, oven doors, hatches and covers. Produced in lengths in sizes up to 150 mm section. Approvals/Certification: Hydrolytische Klasse 1; DIN 12111.

Packing cartridges

Packing cartridges combine quick and easy installation with robust simple construction to provide minimum downtime and maximum reliability in critical process applications. Manufactured to individual requirements to fit into DIN/ASME standard equipment e.g. agitators. Cartridges can be supplied with live-loading and additional bellows containment for maximum environmental safety.

Typical applications:

Pumps, agitators, mixers, kneaders, dryers, fans, blowers, filters, refiners, pulpers, mills, valves

Gaskets



Fibre gasket sheets

Burasil-Basic, -Universal and Buratherm N gasket

sheets for service in low to medium pressure and temperature applications for process equipment and pipework in industry and for utility applications like gas and water supply. Approvals/certification includes: DVGW, KTW, HTB, WRAS, WRC, TA-Luft, BAM (Oxygen max. = 120 °C / 130 bar)

PTFE gasket sheets and tapes

Burachem is a highly chemical resistant modified PTFE gasket material range offering varying properties of mechanical strength and chemical resistance depending upon application. Approvals/certification includes: DVGW, KTW, HTB, WRAS, WRC, BAM (Oxygen max. = 120 °C / 130 bar), TA-Luft.

Quick-Seal MultiTex tape is the latest development in the field of expanded PTFE sealing materials for in-place sealing of vessel and pipe flanges.

Graphite seals and tapes

Statotherm Graphite gasket sheets, tapes

Soft, flexible, graphite gasket sheets ideal for pump, valve, and equipment gaskets.

Statotherm R Profile rings for static sealing in high temperature applications, e.g. in heat exchangers, valves or pumps.

Statotherm V and V-Flex cover seals are used as self-sealing gaskets in high-pressure valves e.g. for power plants at high temperatures. Statotherm V-Flex is supplied by the meter.

Metal gaskets

Approvals/certification include BAM, DVGW, TA-Luft

Spiraltherm spiral wound gaskets. Available to suit all international flange standards and in a wide choice of materials.

Corratherm corrugated gaskets are for heavy duty applications.

Kammprofile serrated gaskets are for applications with high demands for operating safety and tightness.

Buralloy metal jacketed gaskets are produced in a wide variety of different materials (in various combinations), in many styles for heat exchangers, pipe flanges, boilers, and process equipment.

Buralloy ring type joints are available to suit all ASME and DIN flanges from stock. Sizes: 15 ... 900 mm (0.5" ... 36"); manufactured to ASME B16.20 and to API 6A.

Typical applications:

Stationary machine parts, flanges, flange-like joints, bulkheads

For detailed information please inquire.

Additional EagleBurgmann product lines

Expansion joints



Expansion joints are vital components in most industrial plants. They are installed as flexible connections in pipe and duct systems to take up or compensate for thermal expansion, vibration and misalignments. Advancements in processing and generating technologies are being combined with high demands for efficiency. This, along with a clear orientation towards environmental protection, puts high demands on expansion joint designs.

Customized expansion joints made of fabric or metal are the solution of choice.

Fabric expansion joints

- Single and multilayer designs
- Dimensions: according to customer specifications
- Temperature: -35 °C ... +1,000 °C (-31 °F ... + 1,832 °F) (higher temperature, on request)
- Pressure: +/-0.35 bar
- Versions with wiremesh reinforcement
- Versions with high chemical resistance
- Versions with Nekal-tight design
- Fabric expansion joints are available as units, including bolster and steel parts.

Metal expansion joints

- Dimensions: Circular: DN40 and up.
- Rectangular: According to customer specifications
- Temperature: -198 °C ... +1,371 °C (-324 °F ... + 2,500 °F)
- Pressure: vacuum ... 172 bar (... 2,500 PSI)
- Materials: stainless steel, Incoloy®, Inconel®, Hastelloy®, titanium, special materials
- Single and universal designs
- Metal expansion joints are available with for example tie rods, hinges, gimbals, refractory lining, elbow, pantograph.

Dimensions and pressure range depends on design, material selection, type of expansion joint and duct insulation.

Typical applications:

Air and flue gas ducts, pipelines, sewer systems

Special products



For particular applications, innovative, customized solutions are the only answer. The supplier must have a wealth of in-depth expertise, many years of experience and above all the willingness and ability to translate ideas into solutions that work in practical application.

Contoured diaphragm couplings

For demanding rotating equipment such as turbines and compressors in the oil and gas industries as well as petrochemicals, conventional and nuclear power generation, marine applications and the aerospace industry.

They are lightweight, easy to install and maintain, and demonstrate high reliability in stress analysis. Low bearing load, best dynamic balance repeatability and no fretting or wearing are advantages of the coupling. Uniquely shaped flexible elements in the metal diaphragms located at each end of the spacers attain optimum performance. Additional features:

- Couplings acc. to API 671 / ISO10441 or API 610 / ISO13709
- Multi diaphragms, compensation for large misalignments
- Low (reduced) moment
- Electrically insulated
- Spark resistant materials
- Tuned for rotor dynamics
- Torque overload releasing device
- Torque measuring system

Operating range: Max. torque: 2,700 kNm, max. speed: 100,000 min⁻¹

High-grade metal bellows

for specialized applications in the nuclear power, semi conductor and medical equipment industries, etc.

Dynamic and static sealing elements

for the aerospace industry which meet extremely demanding quality requirements.

Stern tube and marine seals

with various approvals and certifications, for marine outfitters and users.

Rotary kiln sealing systems

as single and double seals in drying, calcination, combustion and pyrolysis applications.

Typical applications:

Engineered solutions designed to meet customer requirements

Table of materials

Material code	Description	
¹⁾ EN 12756	EagleBurgmann	
Face materials (Item 1/2)		
Synthetic carbons		
▶ A	Buko 03	Carbon graphite antimony impregnated
▶ B	Buko 1	Carbon graphite resin impregnated, approved for foodstuffs
B3	Buko 02	Carbon graphite resin impregnated
B5	Buko 34	Carbon, resin bonded
C	Buko 22	Electrographite antimony impregnated
Metals		
▶ E	Bume 20	Cr steel
G	Bume 17	CrNiMo steel
▶ S	Bume 5	Special cast CrMo steel
T41	Bube 281	1.4462 DLC-coated
Carbides		
U = Tungsten carbides		
▶ U1	Buka 1 brazed	Tungsten carbide, Co-binder
▶ U2	Buka 16 solid	Tungsten carbide, Ni-binder
▶ U22	Buka 16 shrunk-in	Tungsten carbide, Ni-binder
U3	Buka 15 solid	Tungsten carbide, NiCrMo-binder
U37	Buka 15 shrunk-in	Tungsten carbide, NiCrMo-binder
U7	Buka 17 solid	Tungsten carbide, binder-free
Q = Silicon carbides		
▶ Q1	Buka 22 solid	SiC, silicon carbide, sintered pressureless
▶ Q12	Buka 22 shrunk-in	SiC, sintered pressureless
▶ Q2	Buka 20 solid	SiC-Si, reaction bonded
▶ Q22	Buka 20 shrunk-in	SiC-Si, reaction bonded
Q3	Buka 30 solid	SiC-C-Si, carbon silicon impr.
Q32	Buka 30 shrunk-in	SiC-C-Si, carbon silicon impr.
Q6	Buka 32 solid	SiC-C, SiC sintered pressureless with carbon
Q4	Buka 24 solid	C-SiC, carbon surface silicated
Q19	Buka 221	SiC, DLC-coated
Q15	Buka 225	SiC, DiamondFace
Metal oxides (Ceramics)		
V	Buke 5	Al-Oxide > 99 %
V2	Buke 3	Al-Oxide > 96 %
X	Buke 8	Steatite (Magnesia silicate)

Plastics		
▶ Y1	Buku 2	PTFE glassfibre reinforced
Y2	Buku 3	PTFE carbon reinforced

Material code	Description	
¹⁾ EN 12756	EagleBurgmann	
Secondary seal components (Item 3)		
Elastomers, not wrapped		
B	B	Butyl rubber (IIR ²⁾)
▶ E	E	Ethylene propylene rubber (EPDM ²⁾) e. g. Nordel [®]
K	K	Perfluorocarbon rubber (FFKM ²⁾) e. g. Kalrez [®] , Chemraz [®] , Simriz [®]
N	N	Chloroprene rubber (CR ²⁾) e. g. Neopren [®]
▶ P	P	Nitrile-butadiene-rubber (NBR ²⁾) e. g. Perbunan [®]
S	S	Silicone rubber (VMQ ²⁾) e. g. Silopren [®]
▶ V	V	Fluorocarbon rubber (FKM ²⁾) e. g. Viton [®]
X	X4	Hydrogenated Nitrile-rubber (HNBR ²⁾)
X	X5	Tetrafluoroethylene propylene rubber (FEPM ²⁾) e. g. Aflas [®] , Fluoraz [®]
Elastomers, wrapped		
▶ M1	TTV	FKM, double PTFE wrapped
▶ M2	TTE	EPDM, double PTFE wrapped
M3	TTS	VMQ, double PTFE wrapped
M4	TTN	CR, double PTFE wrapped
M5	FEP	FKM, FEP wrapped
M7	TTV/T	FKM double PTFE wrapped/PTFE solid

Differing materials		
U1	K/T	Perfluorocarbon rubber/PTFE
Non-Elastomers		
G	Statotherm	Pure graphite
T	T	PTFE (Polytetrafluoroethylene)
T2	T2	PTFE glass fiber reinforced
T3	T3	PTFE carbon reinforced
T12	T12	PTFE carbon-graphite reinforced
Y1	Burasil-U	Plastic fiber/Aramid

Material code	Description	
¹⁾ EN 12756	EagleBurgmann	
Spring and construction materials (Item 4/5)		
Spring materials		
▶ G	1.4571	CrNiMo steel
▶ M	2.4610	Hastelloy [®] C-4 Nickel-base alloy
Construction materials		
D	St	C steel
▶ E	1.4122	Cr steel
F	1.4301	CrNi steel
F	1.4308	CrNi cast steel
F1	1.4313	Special cast CrNi steel
▶ G	1.4401	CrNiMo steel
▶ G	1.4404	CrNiMo steel
▶ G	1.4571	CrNiMo steel
G	1.4581	CrNiMo cast steel
▶ G1	1.4462	CrNiMo steel – Duplex
G2	1.4439	CrNiMo steel
G3	1.4539	NiCrMo steel
▶ G4	UNSS32760-Nor	CrNiMoCu steel - Superduplex
M = Nickel-base alloy		
▶ M	2.4610	Hastelloy [®] C-4
M1	2.4617	Hastelloy [®] B-2
M3	2.4660	Carpenter [®] 20 Cb3
M4	2.4375	Monel [®] alloy K500
M5	2.4819	Hastelloy [®] C-276
M6	2.4668	Inconel [®] 718
T = Other materials		
T1	1.4505	CrNiMoCuNb steel
T2	3.7035	Pure titanium
T3	2.4856	Inconel [®] 625
T4	1.3917	Carpenter [®] 42
T5	1.4876	Incoloy [®] 800

- ▶ Preferred materials
 1) Standard following EN 12756, Dec. 2000
 2) Abbreviations acc. to ISO 1629, Nov. 2004

Color code

	Shaft		Stationary seal parts		Rotary seal parts
	Housing, installation chamber		Stationary seal faces		Rotating seal faces
	Elastomers				

Short legend for seal selection by media

Notes on the medium (2) G = Mixture/group N = Natural product ® = Trade mark S = Collective term TA = TA-Luft relevant V = Impurities	Arrangement of shaft seal (5) S = Single mechanical seal D = Dual mechanical seal Q = Quench Auxiliary piping (6) Arrangements see API 682/ISO 21049	Mechanical seal type on product side (8) 1 = with elastomer O-Rings, rotating springs in contact with the product 2 = same as 1 but springs not in contact with the product 3 = same as 2 but stationary springs 4 = same as 2 but metal free on product side 5 = with elastomer bellows 6 = with metal bellows X = special design	Health hazard warnings (10) T = Toxic T+ = Very Toxic Xn = Harmful R. = Carcinogenic/mutagenic Xi = Irritant C = Corrosive 1 = Vapor pressure/gas 2 = Corrosion 3 = Exclusion of air 4 = Lubricating properties 5 = Icing 6 = Leakage F = Highly flammable F+ = Extremely flammable O = Oxidizing E = Explosive N = Dangerous U = Insufficient information	Normal condition (12) ga = Gaseous fe = Solid fl = Liquid kr = Crystalline pa = Viscous Melting point (13) K ... = Effluence temperature Z ... = Decomposition temperature (...) = Sublimation temperature ...% = Values for ...% aqueous solution
Concentration (3) < 10 = "any" < 10 = less than 10 weight % ~ 10 = approx. 10 % F10 = Solids up to 10 % L = Defined solution < L = Unsaturated solution > L = Supersaturated solution Sch = Melt Sus = Suspension	Auxiliary measures (7) D = Steam quench (H), H = Heating (if necessary) kd = Conical stuffing box SS = Splash guard SW = Replacement of buffer medium QW = Replacement of quench medium THE = Thermal buffer	Material selection (9) For designations acc. to EN 12756 see table of materials.	TLV (11) a fig. = TLV in ppm mg = TLV in mg/m ³ # = mg/m ³ of base substance * = No TLV because it is clearly carcinogenic	Density (g/cm³) (15) (+) = Heavier than air (-) = Lighter than air (...) = Reference temp. in °C A ... = Density of the azeotrope at ...% ...% = Values for ...% aqueous solution

TotalSealCare Service

TotalSealCare service modules

The modular seal service offered through TotalSealCare is as individual as are the demands of our customers. The range of services spans complete maintenance of all installed seals, through to stock management, as well as engineering, training and electronic data documentation.

Our TotalSealCare services consist of individual modules from which we assemble individualized service packages.

You can benefit from our many years of experience and expertise in all areas of seal technology, and our major store of practical knowledge.



Consulting & engineering

After establishing and analyzing all of the seals in a system, we work out standardization concepts based on the as-is status. The results we are hoping for are to reduce the number of seal types, sizes and materials used, and to improve the key figures of the system. We advise you relating to codes of practice and statutory regulations, and indicate what actions need to be taken.

Maintenance

In the plant or in the service center, qualified fitters and technicians look after all the aspects of seal maintenance: installation, startup, servicing, conversion, overhaul and repair. We record and document functionally relevant data (fault causes, measures for repair, costs). This means it is possible to assess seal operating times and maintenance costs on a continuous basis, thereby defining measures for extending service intervals.

On-site service

Our on-site service includes the components of an overhaul service, conversions and service container. We deploy a service unit directly on your premises: equipped with the basic suite of seals or a stock of seals discussed with you in advance, and staffed by qualified personnel. On-site, our work includes producing the necessary gaskets, ensuring that the documentation is complete and advising our customers on selecting and installing seals. Our range of services is rounded off by complete conversions (e. g. acc. to TA-Luft).

Inventory management

Based on your individual requirements and the applicable quality regulations, we develop a concept for inventory management of complete seals and spare parts. Furthermore, we optimize stocking on site or in the EagleBurgmann service center. In this way, you can reduce your administration overhead and concentrate on your key operations.

Seminars & training

We offer an extensive range of continuing education programs in seal technology. For service and maintenance personnel, skilled staff and engineers from various branches of industry such as refining, chemicals, power generation, foodstuffs, paper and pharmaceuticals. Our range includes group seminars, individual training and seminars specifically tailored to your requirements. At our premises or at a location of your choice.

Technical analysis & support

A team of seal specialists is responsible for rectifying process malfunctions or "bad actors". The latest methods such as thermography or data logging are used for diagnosing positions that are critical for the operation of the system and for working out measures to rectify them. In our research and development centers, we perform realistic tests on test rigs or in original pumps. The objective is to extend the MTBF and to increase system serviceability by individual and constructive solutions.

Service agreements

We offer our customers specific agreements that can be combined from the six service modules. Whether for individual seal systems, critical process elements, specific system areas or an extensive seal service for complete plants: the modular structure of our service makes it possible to satisfy individual requirements. With our tried-and-tested monitoring instrument, SEPRO, we can also record all data relevant for the seals for documentation and evaluation purposes.

Algeria · Angola · **Argentina** · **Australia** · **Austria** · Bahrain · Bangladesh · Belarus · **Belgium** · Botswana · **Brazil** · Bulgaria · Cameroon · **Canada** · Chile · **China** · **Colombia** · Congo · Cyprus · **Czech Republic** · **Denmark** · **Ecuador** · Egypt · Estonia · Finland · **France** · Gabon · **Germany** · Ghana · **Great Britain** · Greece · **Hungary** · **India** · **Indonesia** · Iraq · Ireland · Israel · **Italy** · Ivory Coast · **Japan** · Jordan · Kazakhstan · Kenya · **Korea** · Kuwait · Latvia · Lebanon · Libya · Lithuania · Madagascar · **Malaysia** · Mauritius · **Mexico** · Morocco · Myanmar · Namibia · **Netherlands** · **New Zealand** · Nigeria · **Norway** · Oman · Pakistan · Paraguay · Peru · **Philippines** · **Poland** · Qatar · Romania · **Russia** · **Saudi Arabia** · Serbia · **Singapore** · Slovak Republic · Slovenia · **South Africa** · **Spain** · Sudan · **Sweden** · **Switzerland** · **Taiwan** · **Thailand** · Trinidad and Tobago · Tunisia · **Turkey** · Ukraine · **United Arab Emirates** · Uruguay · **USA** · **Venezuela** · **Vietnam** · Yemen · Zambia · Zimbabwe · www.eagleburgmann.com/world



DMS_TSE / E3 / 3.000 / 07.15 / 9.7.1 © EagleBurgmann Group Marketing, Germany

EagleBurgmann is one of the internationally leading companies for industrial sealing technology. Our products are used everywhere where safety and reliability are important: in the oil and gas industry, refining technology, the petrochemical, chemical and pharmaceutical industries, food processing, power, water, mining, pulp & paper, aerospace and many other spheres. Every day, more than 6,000 employees contribute their ideas, solutions and commitment towards ensuring that customers all over the world can rely on our seals. Our modular TotalSealCare service underlines our strong customer orientation and offers tailor-made services for every application.

eagleburgmann.com

info@eagleburgmann.com

EagleBurgmann®

Rely on excellence